

# TRAFFIC IMPACT STUDY FOR PERTHMORE SUBDIVISION IN PERTH, ONTARIO

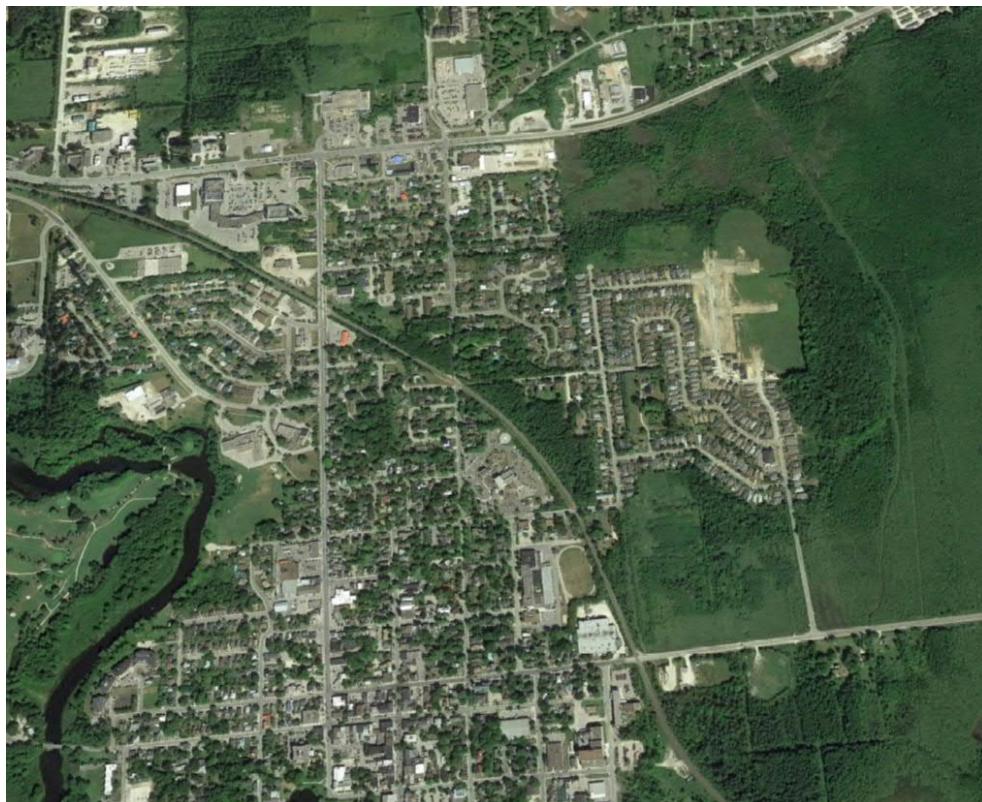

Project No.: CC0-13-9668

Prepared for:

Perthmore Enterprise Inc.  
3 Senators Gate Drive  
Perth, ON K7L 5J8

Prepared by:

McIntosh Perry Consulting Engineers Ltd.  
115 Walgreen Road  
Carp, ON K0A 1L0  
Tel: 613-836-2184

August 2022

# EXECUTIVE SUMMARY

McIntosh Perry Consulting Engineers Ltd. (MP) has been retained by Perthmore Enterprise Inc. to prepare a Traffic Impact Study (TIS) for the proposed expansion of the existing Perthmore subdivision in the Town of Perth.

Previous TIS was submitted in December 2020, with updates to the site plan in May 2022 reducing the number of units. In June 2022 a third iteration of the site plan was developed which included:

- 35 single family detached homes and 18 duplexes throughout lots 1-53;
- Additional 8 basement units at lots 50-53; and,
- 14-unit apartment building located on lot 54.

MP reviewed the existing road/street network for the 2020 existing conditions as a baseline model. MP then reviewed the 2030 buildout year and the 2035, 5-year horizon scenarios where just the background traffic growth was applied to the network, illustrating the scenarios where the proposed development is not built. MP then reviewed the 2030 buildout year and 5-year horizon for the total traffic scenario including both the background traffic growth and the trips generated by the proposed development for comparison.

Based on traffic assessment and analysis, the proposed development is anticipated to have minimal impact to the proposed road network and majority of traffic movements and intersection approaches operating at or below capacity. The study analysis also recommends the intersection of North Street and Drummond Street signalisation, from the current all way stop control.

Prepared by,

William Sherwin, EIT



Transportation and Traffic Engineering Intern

[w.sherwin@mcintoshperry.com](mailto:w.sherwin@mcintoshperry.com)

613.714.5929

Thomas Gryz, M.A.Sc., P.Eng.



Transportation and Traffic Engineer

[t.gryz@mcintoshperry.com](mailto:t.gryz@mcintoshperry.com)

613.903.5772

**TABLE OF CONTENTS**

1.0 INTRODUCTION ..... 1

2.0 PROPOSED DEVELOPMENT..... 1

3.0 EXISTING CONDITIONS ..... 2

    3.1 Site Location ..... 2

    3.2 Road Network..... 3

        3.2.1 Roadways ..... 3

        3.2.2 Intersections ..... 5

    3.3 Transit.....13

    3.4 Traffic Volume and Characteristics.....13

4.0 FUTURE CONDITIONS ..... 16

    4.1 Planning Context .....16

    4.2 Background Traffic Growth.....16

    4.3 Other Planned Developments.....16

    4.4 Trip Generation.....16

    4.5 Trip Distribution and Trip Assignment .....18

5.0 LEVEL OF SERVICE AND OPERATING CONDITIONS..... 22

    5.1 Methodology .....22

    5.2 Existing Conditions.....23

    5.3 Future Growth – Background Traffic Only .....25

        5.3.1 Buildout Year (2030) .....25

        5.3.2 5 Year Horizon (2035) .....26

    5.4 Future Conditions – Total Traffic .....27

        5.4.1 Buildout Year (2030) .....27

        5.4.2 5 Year Horizon (2035) .....28

6.0 MITIGATIONS ..... 29

    6.1 Signal Warrants.....29

    6.2 Signal Optimization: Total Traffic Horizon 2035 .....29

    6.3 Traffic Operations with Mitigation Measures.....29

7.0 SUMMARY, RECOMMENDATIONS AND CONCLUSION ..... 31

List of Figures

Figure 3.1.1 Proposed Site Location (Source: Google Earth)..... 2

Figure 3.2.1 Intersections (Source: Google Earth)..... 5

Figure 3.2.2 Intersection of Perthmore Street and Drummond Concession 2 / North Street (Source: Google Earth) ..... 6

Figure 3.2.3 Intersection of Drummond Street and North Street (Source: Google Earth) ..... 7

Figure 3.2.4. Intersection of Isabella Street and Victoria Street (Source: Google Earth)..... 8

Figure 3.2.5 Intersection of Drummond Street and Highway 7 (Source: Google Earth)..... 9

Figure 3.2.6 Intersection of Wilson Street and Highway 7 (Source: Google Earth).....10

Figure 3.2.7 Intersection of Wilson Street and Sunset Boulevard/Harris Street (Source: Google Earth).....11

Figure 3.2.8 Intersection of Wilson Street and Isabella Street/Leslie Street (Source: Google Earth) .....12

Figure 3.2.9 Intersection of Wilson Street and North Street (Source: Google Earth).....13

Figure 3.4.1 Existing Conditions Traffic Volumes.....15

Figure 4.5.1 Road network for High Level Distribution (Source: Google Earth).....18

Figure 4.5.2 Trip Distribution.....20

Figure 4.5.3 Trip Assignment.....21

List of Tables

Table 3.1 Turning Movement Count Locations .....14

Table 4.1 ITE Land Use and Land Use Code.....16

Table 4.2 ITE Trip Generation.....17

Table 4.3 High-Level Distribution.....18

Table 5.1 Definition of LOS for a Signalized Intersection.....22

Table 5.2 Definition of LOS for an Unsignalized Intersection.....23

Table 5.3 Existing (2020) Traffic Conditions .....24

Table 5.4 Background Buildout 2030 Critical Movements.....25

Table 5.5 Background Horizon 2035 Critical Movements.....26

Table 5.6 Total Buildout 2030 Critical Movements .....27

Table 5.7 Total Horizon 2035 Critical Movements .....28

Table 6.1 Total Traffic Horizon 2035 with Mitigation Critical Movements .....30

## Appendices

Appendix A – Site Plan

Appendix B – Perth Transit Schedule

Appendix C – Traffic Data

Appendix D – Volume Figures

Appendix E – Synchro 11 Output Reports

Appendix F – Detailed LOS Summary Tables

Appendix G - Mitigations

## 1.0 INTRODUCTION

McIntosh Perry Consulting Engineers Ltd. (MP) has been retained by Perthmore Enterprise Inc. to develop a Traffic Impact Study (TIS) for the proposed expansion of the Perthmore subdivision in the Town of Perth. The study is prepared in support of the site plan application and is submitted to the Town of Perth for their review and approval. The study will address potential traffic impacts of the development to the surround traffic network.

## 2.0 PROPOSED DEVELOPMENT

The proposed development will be an extension of the existing Perthmore subdivision located between Drummond Concession 2 (County Road 10) and Highway 7, in the Town of Perth. The proposed development includes a mix of 35 single family detached homes and 18 duplexes throughout lots 1-53, lots 50-53 includes an additional 8 basement units, and a 14-unit apartment building located on lot 54. The development will be using the existing traffic roadway networks to the west (Isabella Street) and south (Drummond Concession 2) of the development. The site plan is provided in [Appendix A](#).

(This section is left blank intentionally)



## 3.0 EXISTING CONDITIONS

### 3.1 Site Location

The proposed development site is located within the Town of Perth towards the north-east boundary between Highway 7 and Drummond Concession 2. The proposed development will be an expansion on the pre-existing Perthmore subdivision. The site of the expansion is currently vacant and is in Resident First Density (R1-h) Zone; Bylaw 3358-63. [Figure 3.1](#) illustrates the site location and the surrounding area.

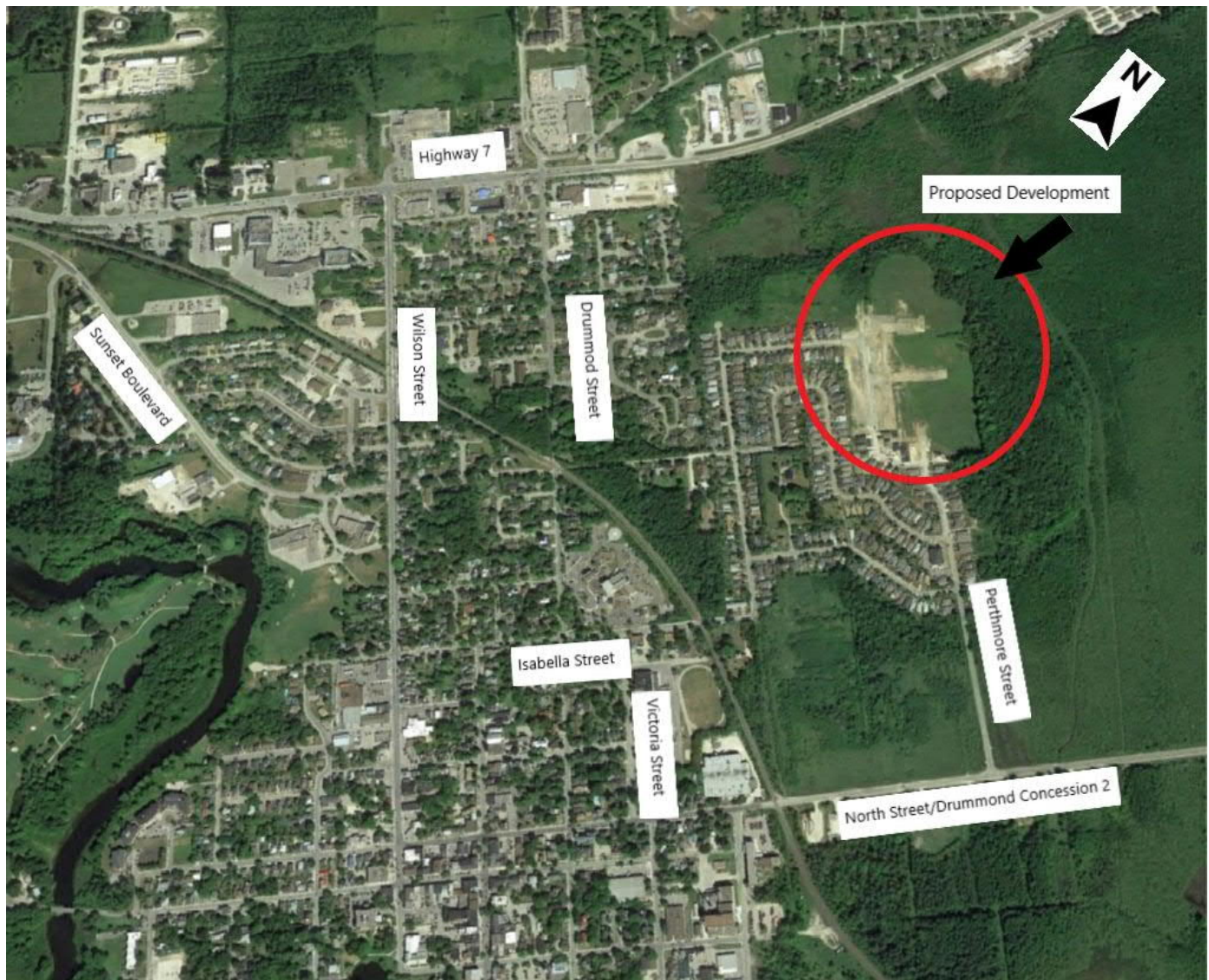

Figure 3.1.1 Proposed Site Location (Source: Google Earth)

## 3.2 Road Network

### 3.2.1 Roadways

The study area roadways include:

- Drummond Concession 2 (County Road 10)/ North Street;
- Perthmore Street;
- Drummond Street;
- Wilson Street West;
- Sunset Boulevard;
- Isabella Street;
- Victoria Street; and,
- Highway 7.

Drummond Concession 2 (County Road 10) is one of the major east-west commuter routes towards the Town of Smith Falls. Drummond Concession 2 is a two-lane undivided roadway with a posted speed limit of 50 km/h but transitions to a posted speed of 60 km/h approximately 375 m to the east of the intersection of Drummond Concession 2/ North Street and Perthmore Street. Drummond Concession 2 ends at the intersection of Drummond Concession 2 and Perthmore Street in which County Road 10 continues west into the Town of Perth as North Street. North Street runs east-west from the intersection of Drummond Concession 2 / North Street and Perthmore Street in the east to Lustre Lane in the west approximately 1.5 km away. North Street is a two-lane undivided roadway with a posted speed limit of 50 km/h. Drummond concession 2 is under the jurisdiction of the Township of Perth.

Perthmore Street is a local road that runs north-south, connecting the existing Perthmore subdivision to Drummond Concession 2. Perthmore Street has an unposted speed limit of 50 km/h, with unpaved shoulders. Perthmore Street is under the jurisdiction of the Township of Perth.

Drummond Street runs north-south within the Town of Perth. Drummond Street is a two-lane, undivided, arterial road with a posted speed limit of 50 km/h. There are concrete curbs along both sides of the road and a concrete sidewalk along the east side of the road. There are posted no Heavy Vehicles and no Parking signs along Drummond Street in accordance with By-law 3961. Drummond Street is under the jurisdiction of the Township of Perth.

Wilson Street West runs north-south within the Town of Perth. Wilson Street is a two-lane, undivided, arterial roadway with a posted speed limit of 50 km/h. There are concrete curbs and sidewalks on both sides of the street, designated bike lanes on both sides of the street as well as street parking within the downtown core. There are also several driveways along Wilson Street serving the various commercial businesses along the road. Wilson Street West is under the jurisdiction of the Township of Perth.

Sunset Boulevard runs east-west within the Town of Perth. Sunset Boulevard is a two-lane, undivided arterial with a posted speed limit of 50 km/h. There are concrete curbs along both sides of the roadway, a paved



shoulder on the north side of the road and a concrete sidewalk on the south side of the road. Sunset Boulevard is under the jurisdiction of the Township of Perth.

Isabella Street is a two-lane undivided local roadway with an unposted speed limit of 50 km/h that runs east-west. There are concrete curbs and sidewalks along both sides of the road from Wilson Street to Gore Street. After Gore Street the sidewalk ends on the south side of the road and only the concrete curb continues. There are posted no parking signs all along Isabella Street. Isabella Street services both the Hospital in Perth and the Perthmore Subdivision via Garden Avenue. Isabella Street is under the jurisdiction of the Township of Perth.

Victoria Street is a two-lane undivided local roadway with an unposted speed limit of 50 km/h that runs north-south from North Street to Isabella Street. There are concrete sidewalks and curbs on both sides of the roadway, where the west side sidewalk ends after the intersection of Victoria Street and Darcy Street, where just the concrete curb continues hence for to the north. There are posted no parking signs from North Street to Darcy Street, north of that there is on street parking on the east side of the roadway. Victoria Street is under the jurisdiction of the Township of Perth.

Highway 7 runs east-west within the Town of Perth. Highway 7 is a four lane, undivided highway with a posted speed limit of 60 km/h. Within the study limit, Highway 7 has unpaved shoulders and multiple commercial driveway access to the north and south of the roadway. Highway 7 is under the jurisdiction of the MTO.

### 3.2.2 Intersections

This section summarizes the existing intersections to be included in the analysis, identifying their respective intersection control type and lane configurations. Figure 3.2.1 shows the location of the intersections in relation to the proposed development.

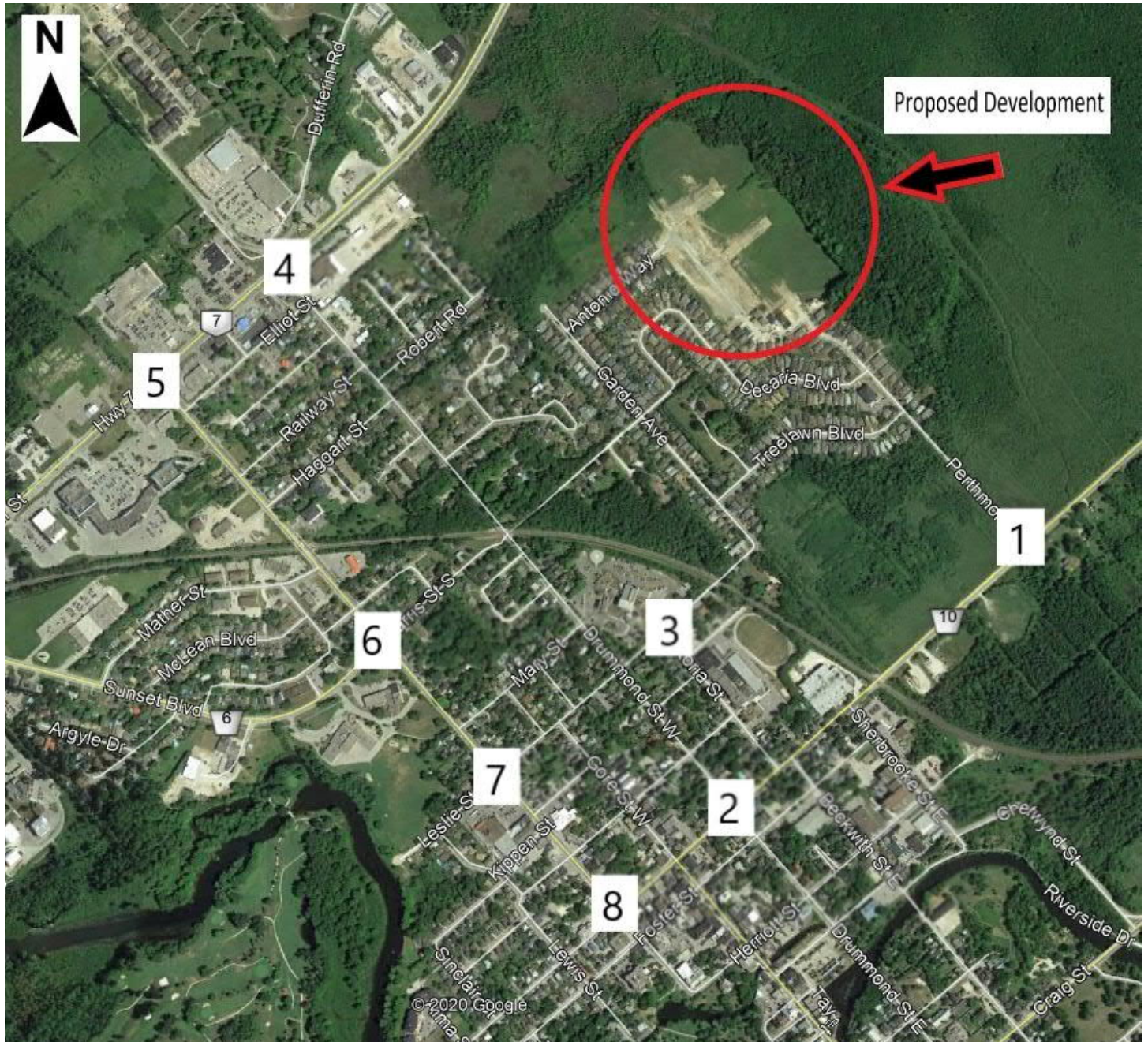

Figure 3.2.1 Intersections (Source: Google Earth)



The image above shows the position of the following intersections in relation to the proposed development:

- 1: Perthmore Street and Drummond Concession 2/North Street (Unsignalized)
- 2: Drummond Street and North Street (Unsignalized);
- 3: Victoria Street and Isabella Street (Unsignalized);
- 4: Drummond Street and Highway 7 (Signalized);
- 5: Wilson Street and Highway 7 (Signalized);
- 6: Wilson Street and Sunset Boulevard (Signalized);
- 7: Wilson Street at Isabella Street (Signalized); and,
- 8: Wilson Street and North Street (Unsignalized).

### 3.2.2.1 Perthmore Street and Drummond Concession 2 / North Street

The intersection of Perthmore Street and Drummond Concession 2 is an unsignalized, two-way stop-controlled intersection. The westbound approach has a through lane and one auxiliary right turn lane. The eastbound approach has a shared through and left turn lane. The southbound approach has a stop-controlled shared left-right turning lane. [Figure 3.2.2](#) illustrates this intersection.



Figure 3.2.2 Intersection of Perthmore Street and Drummond Concession 2 / North Street (Source: Google Earth)

### 3.2.2.2 Drummond Street and North Street

The intersection of Drummond Street and North Street is an unsignalized, all-way stop-controlled intersection. All legs of the intersection have a shared left-through-right lane. There is parking along the northeast bound lane of North Street. Figure 3.2.3 illustrates the intersection.

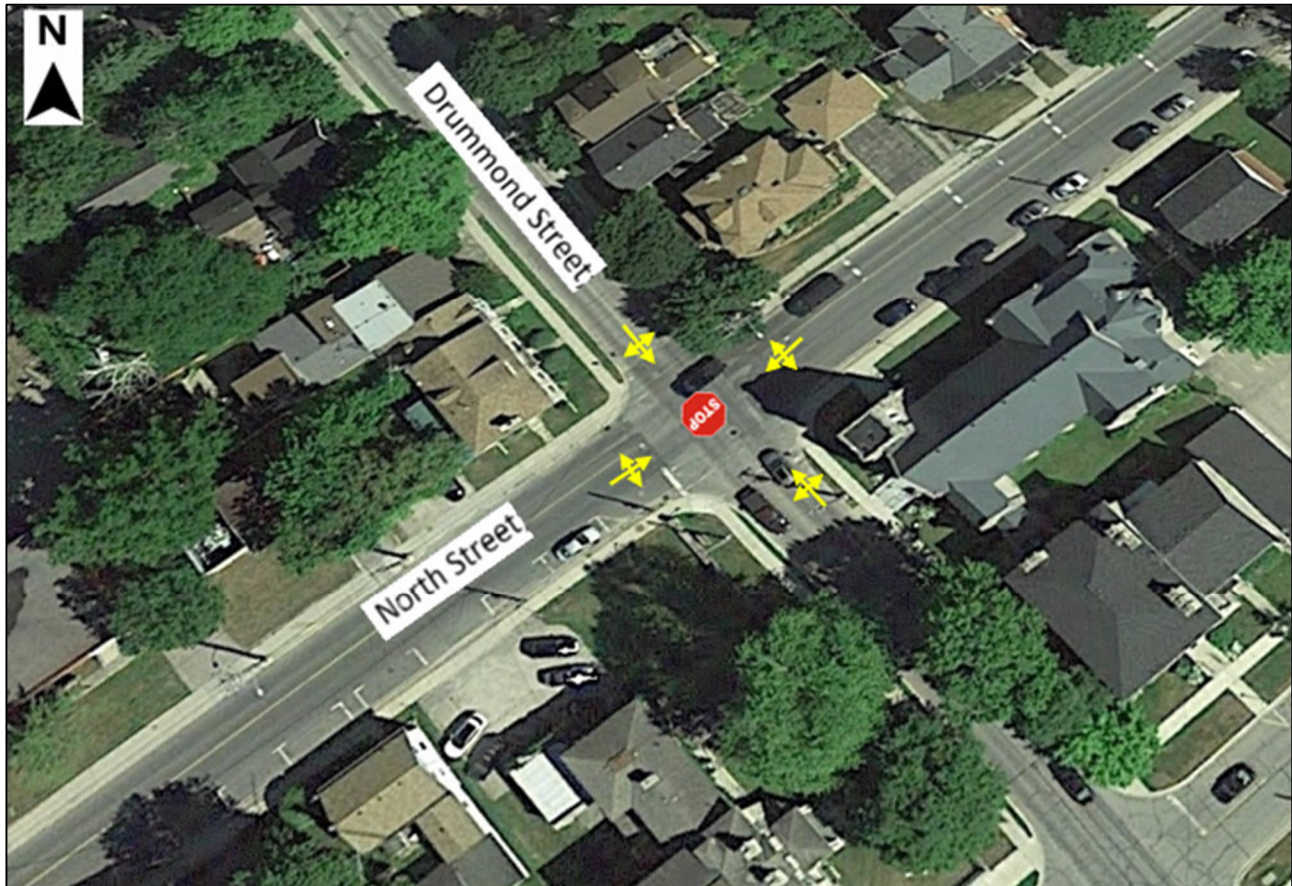

Figure 3.2.3 Intersection of Drummond Street and North Street (Source: Google Earth)



### 3.2.2.3 Victoria Street and Isabella Street

The intersection of Victoria Street and Isabella Street is an unsignalized, two-way stop-controlled intersection. The eastbound approach has a shared right-through lane, the westbound lane has a shared left-through lane, and the northbound approach has a shared left-right turn lane. The visitor access to the Perth and Smith Falls District Hospital is directly to the east of the intersection along Isabella. There is Perth and District Collegiate School located approximately 70 m south; of the intersection. Figure 3.2.4 illustrates the intersection.



Figure 3.2.4. Intersection of Isabella Street and Victoria Street (Source: Google Earth)



### 3.2.2.4 Drummond Street and Highway 7

The intersection at Drummond Street and Highway 7 is a signalized intersection. The northbound approach and southbound approach each have a shared right through lane and an auxiliary left turn lane. The eastbound approach has a shared right-through lane and a share left-through lane. The westbound approach has a share left-through lane, a through lane and a right-turn auxiliary lane. [Figure 3.2.5](#) illustrates this intersection

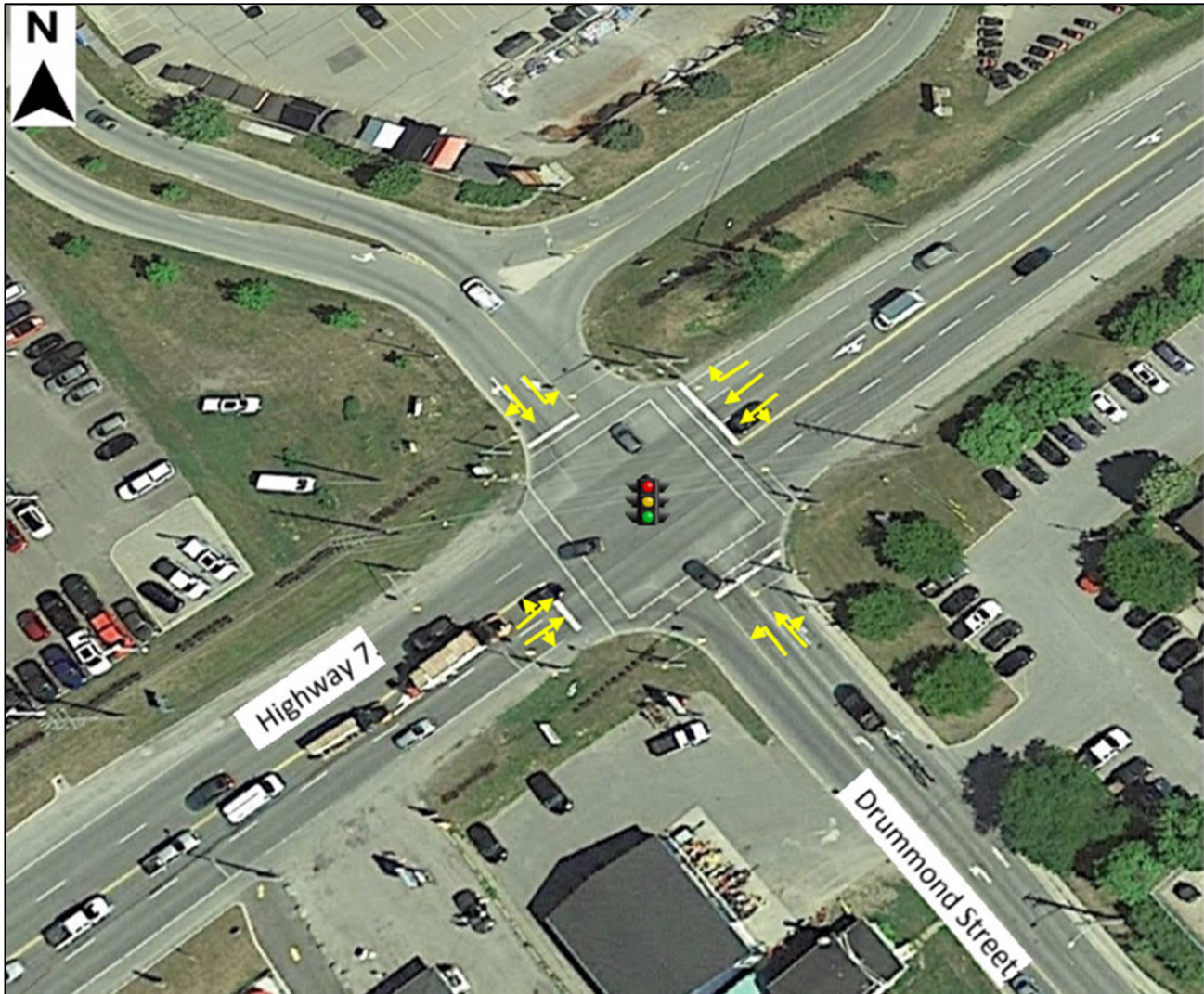

Figure 3.2.5 Intersection of Drummond Street and Highway 7 (Source: Google Earth)



### 3.2.2.5 Wilson Street and Highway 7

The intersection at Wilson Street and Highway 7 is a signalized intersection. The northbound and southbound approaches both have a shared left-through lane and a right-turn lane. The eastbound and westbound approaches both have a shared left-through and a shared through-right lane. Figure 3.2.6 illustrates the intersection.

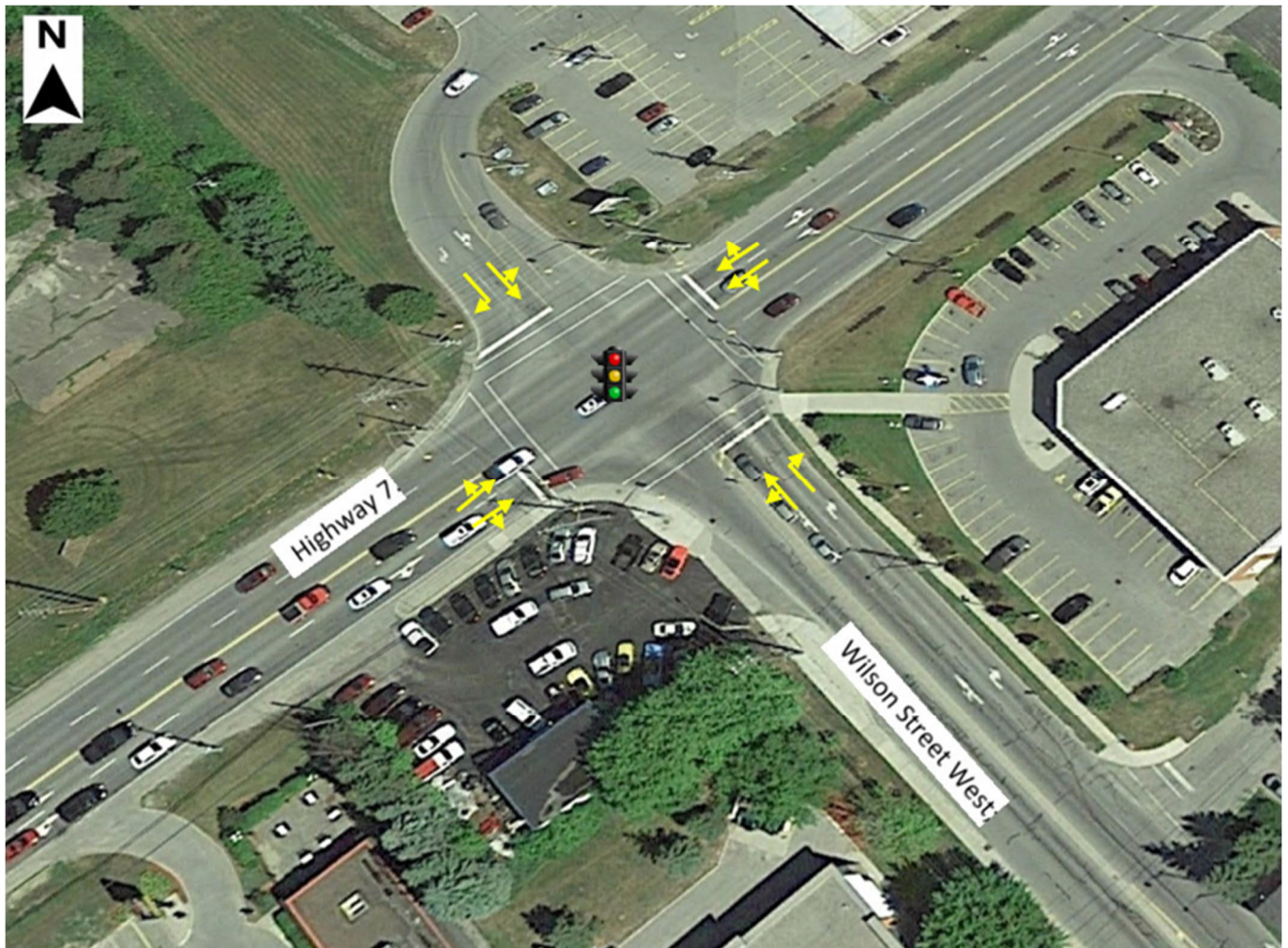

Figure 3.2.6 Intersection of Wilson Street and Highway 7 (Source: Google Earth)

### 3.2.2.6 Wilson Street and Sunset Boulevard/ Harris Street

The intersection of Wilson Street and Sunset Boulevard/Harris Street is a signalized intersection. The northbound approach has a shared through-right lane and an auxiliary left-turn lane. The southbound approach has a right-turn lane, a through lane and an auxiliary left-turn lane. The eastbound approach has a shared left-through lane and a right-turn lane. The westbound approach has a single shared left-through-right lane. Figure 3.2.7 illustrates the intersection.

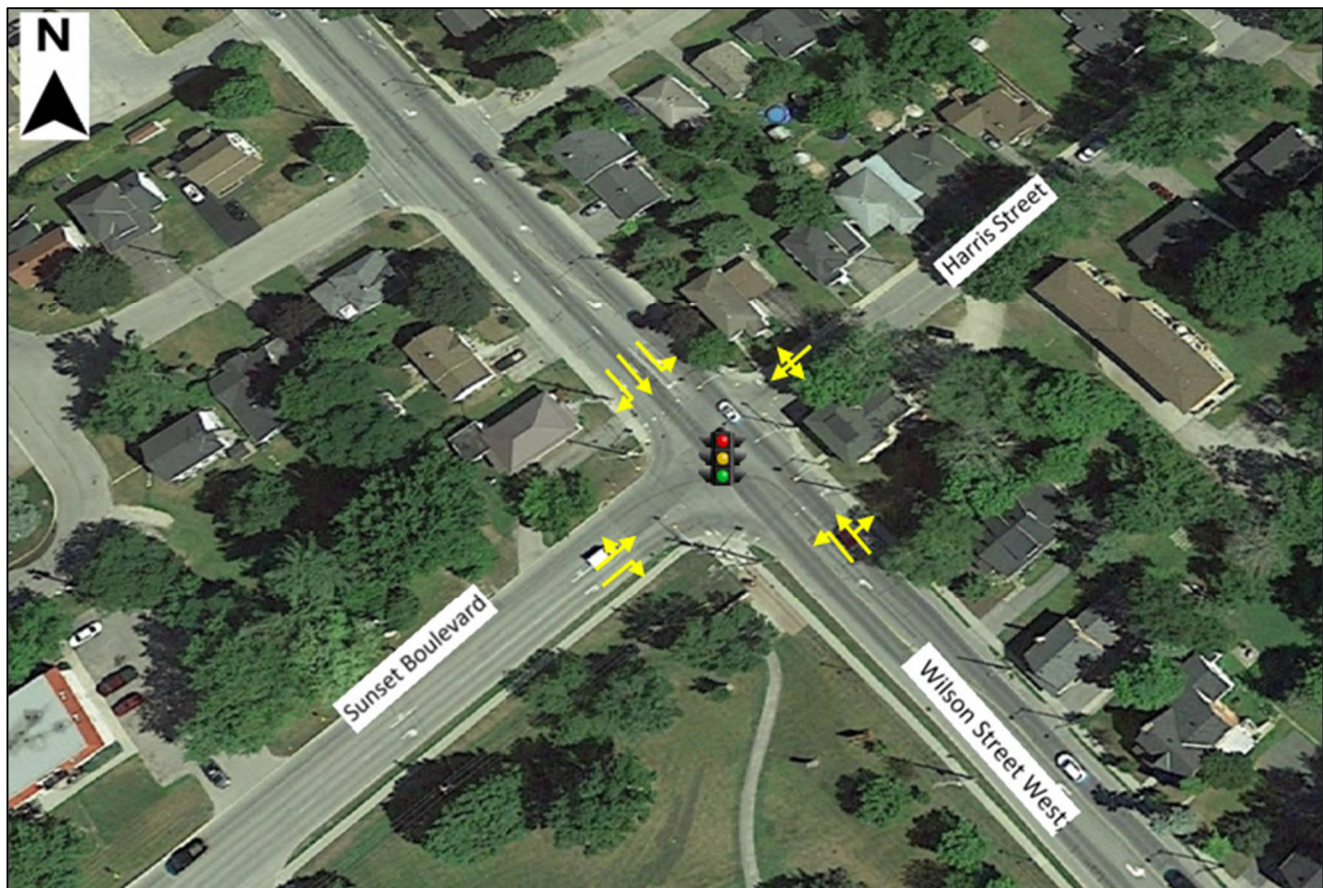

Figure 3.2.7 Intersection of Wilson Street and Sunset Boulevard/Harris Street (Source: Google Earth)



### 3.2.2.7 Wilson Street and Leslie Street/Isabella Street

The intersection of Wilson Street and Isabella Street is a signalized intersection. Both the north and southbound approaches have a shared through-right lane and an auxiliary left-turn lane. Both the east and westbound approaches have a single shared left-through-right lane. Figure 3.2.8 illustrates the intersection.



Figure 3.2.8 Intersection of Wilson Street and Isabella Street/Leslie Street (Source: Google Earth)

### 3.2.2.8 Wilson Street and North Street

The intersection of Wilson Street and North Street is a two-way stop-controlled intersection with stop-control provided for the North Street approaches. The southbound approach has a shared through-right lane and an auxiliary left turn lane. It was noted during the field review that the left turn lane is used as a shared left-through lane by motorists. Therefore, for the purpose of the TIS, this lane has been analyzed as a left-through lane. The northbound approach has a shared left-through-right lane. Both the east and westbound approaches have a single shared left-through-right lane. [Figure 3.2.9](#) illustrates the intersection.



Figure 3.2.9 Intersection of Wilson Street and North Street (Source: Google Earth)

## 3.3 Transit

There is no public transit system in place for the Town of Perth. However, there is an interregional private bus service that travels from Perth to Ottawa daily during the work week. The bus has 2 stops in Perth and they are at the Giant Tiger (88 Dufferin Street) and at the corner of Highway 7 and Leach Road. The transit schedule can be found in [Appendix B](#).

## 3.4 Traffic Volume and Characteristics

The Ministry of Transportation (MTO) provided TMC data and corresponding traffic signal timing plans for the intersections along the Highway 7 corridor. Additionally, in 2019 and 2022 MP collected Turning Movement



Counts (TMC) data from 07:00 h - 09:30 h and 14:45 h -17:15h for the remaining study intersections. [Table 3.1](#) summarizes the data acquired by MP and provided by the MTO.

Table 3.1 Turning Movement Count Locations

Agency	Location	Date
MTO	Wilson Street at Highway 7	31-Jul-19
	Drummond Street at Highway 7	31-Jul-19
McIntosh Perry	Perthmore Street at Drummond Concession 2/ North Street	05-May-19
	Drummond Street at North Street	05-May-19
	Isabella Street at Victoria Street	22-Jan-20
	Isabella Street/ Leslie Street at Wilson Street	22-Jan-20
	North Street at Wilson Street	23-Jan-20
	Sunset Boulevard/ Harris at Wilson Street	23-Jan-20

Provided TMC and traffic signal timing data can be found in [Appendix C](#).

[Figure 3.4.1](#) shows the existing conditions volume figure, other volume figures can be found in [Appendix D](#).

(This section is left blank intentionally]

Figure 3.4.1 Existing Conditions Traffic Volumes

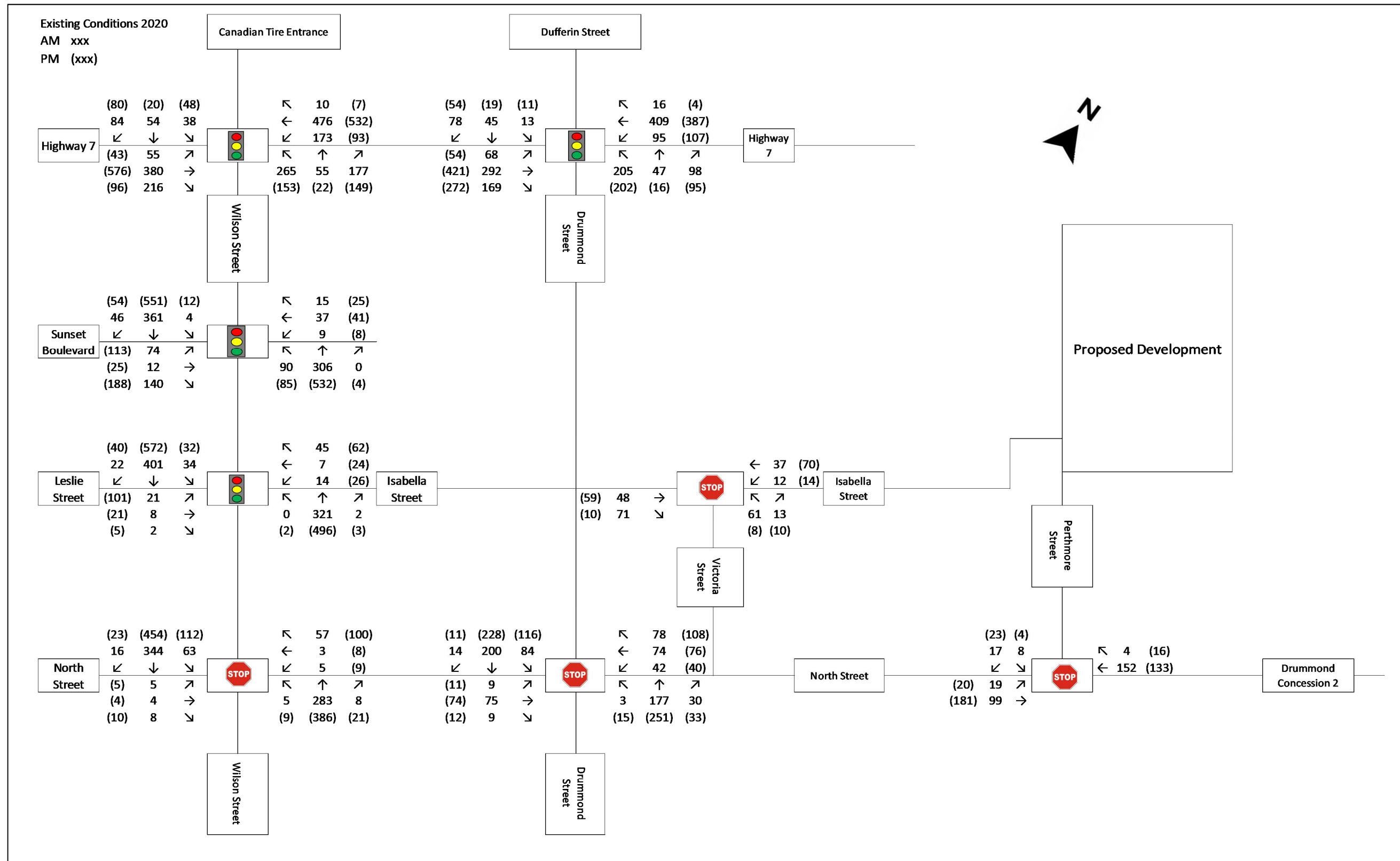

## 4.0 FUTURE CONDITIONS

### 4.1 Planning Context

The development area is currently within a Resident First Density (R1-h) Zone; Bylaw 3358-63.

### 4.2 Background Traffic Growth

Background traffic growth is a function of the projected population growth, changes to employment, roadway network modifications and other external factors. The Township of Perth's Growth Management Strategy (2014) indicated a population growth of 4,640 by the year of 2041 from 5,860 in 2014. This increase is a growth rate of 79% which translates to a yearly growth rate of 2.18%. The Lanark County Sustainable Communities Official Plan showed the total population of the Town of Perth increasing from 5,860 (2014) to 7,615 in 2031, this translates to a growth rate of 30% and a yearly growth rate of 1.55%. Therefore, a yearly growth rate of 2.5% will be used for the purpose of this study.

### 4.3 Other Planned Developments

Currently there are no planned developments within the vicinity of the proposed development. However, MTO has plans to widen Highway 7 between Wilson Street and Drummond Street. This includes geometric and operational changes to the intersections of Highway 7 at Wilson Street and Highway 7 at Drummond Street. The detail design for the reconstruction of Highway 7 through Perth is underway, however has not been finalized yet.

### 4.4 Trip Generation

Trip generation for the proposed development was calculated in accordance with Institute of Transportation Engineers (ITE) Trip Generation 11<sup>th</sup> Edition methodologies and data. The development is expected to include 54 lots split into 35 single family homes and 18 duplexes, with lot 50-53 including an additional 8 basement units, and lot 54 including a 14-unit apartment building. For the purpose of the trip generation of this study each duplex shall be considered as two single family homes, and each basement unit will count as one single family home. The applicable land use codes for each of the dwelling types are summarized in [Table 4.4.1](#).

Table 4.1 ITE Land Use and Land Use Code

Proposed Land Use	ITE Land Use	Land Use Code
Apartment	Multifamily Housing Low-Rise	220
Duplex	Single Family Detached Housing	210
Detached House	Single Family Detached Housing	210

Table 4.2 ITE Trip Generation.

Land Use	Units	Land Use Code	ITE Trip Generation rate		Trips					
					AM			PM		
			AM	PM	Total	In	Out	Total	In	Out
Apartment	14	220	0.4	0.51	6	1	5	7	4	3
Duplex	18 (36 units)	210	0.7	0.94	25	6	19	34	21	13
Detached House	35	210			25	6	19	33	21	12
Basement Units	8	210			6	1	5	8	5	3
Total					62	14	48	82	51	31

As shown in Table 4.4.2 the proposed development is anticipated to generate 62 Trips during the AM peak with 14 entering the site and 48 exiting the site. During the PM peak the proposed development is anticipated to generate 82 total trips with 51 entering the site and 31 exiting. The directional split of trips generated are as followed:

- The Duplex and the Detached House both have a directional split of 26%/74% entering/exiting during the AM Peak Hour and a split of 63%/37% entering/exiting during the PM Peak Hour; and,
- The Apartment complex has a directional split of 24%/76% entering/exiting during the AM Peak Hour and a split of 63%/37% entering/exiting during the PM Peak Hour.

The recommended ITE procedure for estimating internal trip capture is only applicable for mixed use development. Therefore, internal trips were not considered in the trip generation analysis.

The proposed development's new residential units do not affect existing volumes through pass-by trips. Therefore, pass-by trips are not considered in the trip generation analysis.

Mode split will typically include other transportation mode, such as auto-passenger, transit, biking and walking. Due to a lack in available mode split data, it is assumed that the new trips will be made up entirely of new auto-driver trips in order to create a more conservative scenario.

### 4.5 Trip Distribution and Trip Assignment

The distribution of trips is developed only considering new trips. As such, the new residential units will act as the origin and destination of the new trips during the respective peak hours.

High-level trip distribution was taken from Table 2 of the 2016 Perth Transportation Master Plan, Future Traffic Forecasting Memo prepared by Stantec. Figure 4.5.1. shows the roadways mentioned in the table.



Figure 4.5.1 Road network for High Level Distribution (Source: Google Earth)

The higher-level trip distribution of generated trips from the development is as summarized in Table 4.3.

Table 4.3 High-Level Distribution

Direction	Via	Split
South	Craig Street, Rideau Ferry Road, and South Street/Scott Street	50%
West	Highway 7 and Sunset Boulevard	25%
East	Highway 7 and North Street	25%



The new trip distribution was derived from Table 2 from the Township of Perth TMP and planning assumptions from [Section 3.4](#). [Figure 4.5.2](#) and [Figure 4.5.3](#) illustrates the trip distribution and trip assignment for the proposed development based on the higher-level distribution as indicated in [Table 4.3](#).



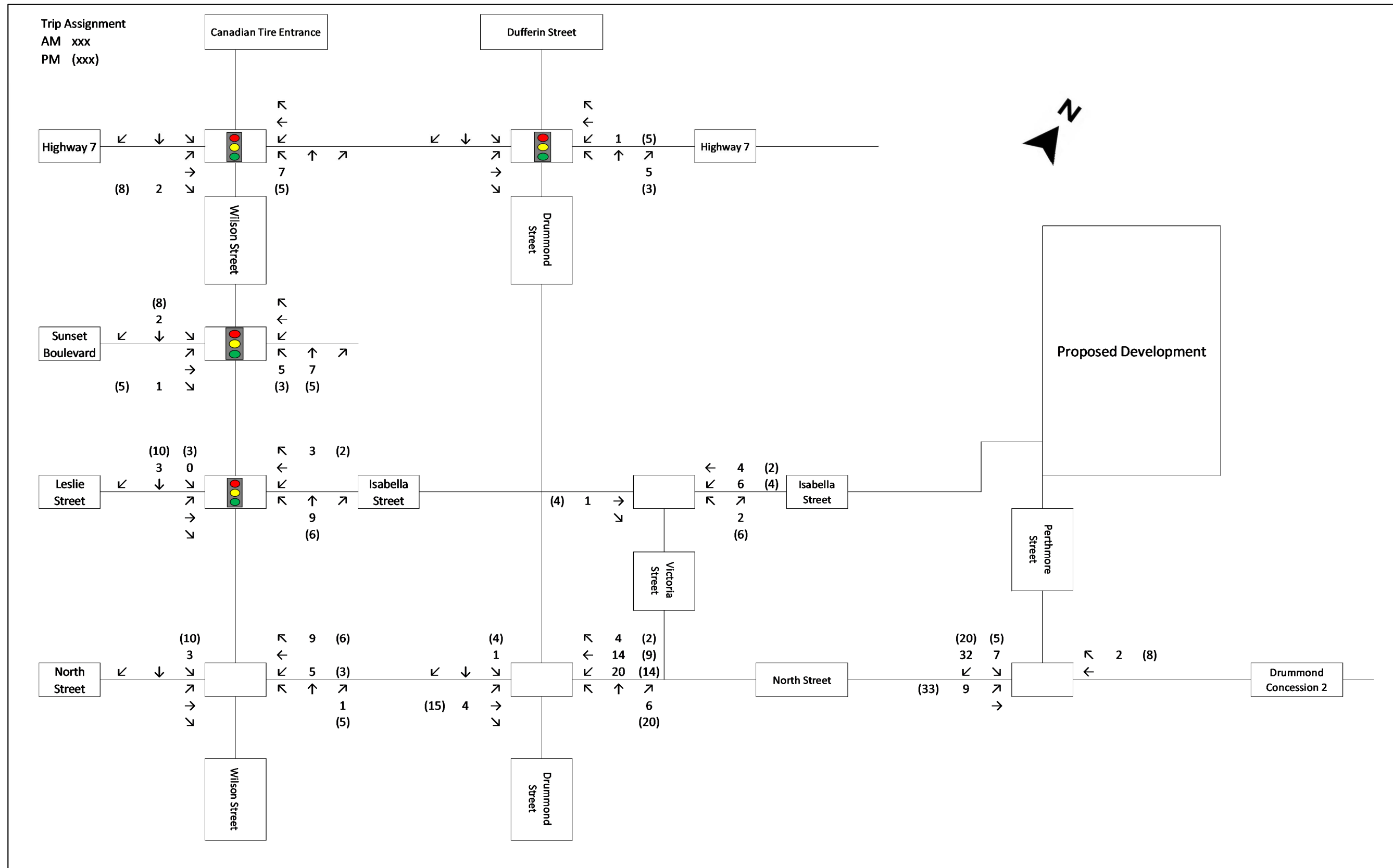

Figure 4.5.3 Trip Assignment

## 5.0 LEVEL OF SERVICE AND OPERATING CONDITIONS

### 5.1 Methodology

Level of Service (LOS) is a qualitative measure of the intersection operating conditions, based on lane configuration, traffic signal operation/phasing. LOS criteria for signalized intersection based on HCM 6<sup>th</sup> Edition, are illustrated in [Table 5.1.1](#). An intersection operates at an unsatisfactory condition when the critical approach movement has either a LOS of E or worse, or a v/c of 0.9 or greater.

Table 5.1 Definition of LOS for a Signalized Intersection

Level of Service	Average Total Delay (Seconds)	v/c Ratio
A	< 10.0	< 1.0
B	10 to 20	< 1.0
C	20 to 35	< 1.0
D	35 to 55	< 1.0
E	55 to 80	< 1.0
F	> 80	> 1.0

LOS criteria for unsignalized intersections is determined as a function of average total delay for specific turning movements. Based on HCM 6<sup>th</sup> Edition, the level of service categories are illustrated in [Table 5.1.2](#).

Table 5.2 Definition of LOS for an Unsignalized Intersection

Level of Service	Average Total Delay (Seconds)	v/c Ratio
A	< 10.0	< 1.0
B	10 to 15	< 1.0
C	15 to 25	< 1.0
D	25 to 35	< 1.0
E	35 to 50	< 1.0
F	> 50	> 1.0

Traffic operation analysis was performed using Synchro 11 software. Synchro 11 output sheets can be found in [Appendix E](#).

## 5.2 Existing Conditions

The existing Traffic volumes were analyzed using Synchro 11 software. The existing traffic conditions for the AM (7:45-8:45) and PM (15:30-16:30) Peak hour were developed using the turning movement counts. Calibration of the model was done through the use of the peak hour factor (PHF) and heavy vehicle percentages (HV%) which was determined through the TMC data. [Table 5.2.1](#) summarizes the 2020 existing traffic operations within the study area.



Table 5.3 Existing (2020) Traffic Conditions

Intersection	Am Peak Hour			PM Peak Hour		
	LOS	v/c Ratio	Total Delay (Sec)	LOS	v/c Ratio	Total Delay (Sec)
Drummond Concession 2 at Perthmore Street						
Eastbound Left-Through	A	0.01	8	A	0.02	8
Westbound Through	-	-	-	-	-	-
Westbound Right	-	-	-	-	-	-
Southbound Left-Right	A	0.04	10	A	0.05	10
Isabella Street at Victoria Street						
Eastbound Through-Right	A	0.01	8	-	-	-
Westbound Left-through	A	-	0	A	0.01	7
Northbound Left-Right	B	0.24	11	A	0.03	9
North Street at Wilson Street						
Eastbound Left-Through-Right	C	0.09	19	D	0.15	28
Westbound Left-Through-Right	B	0.16	13	C	0.30	17
Northbound Left-Through-Right	A	0.01	8	A	0.01	9
Southbound Left-Through	A	0.08	9	A	0.12	9
Southbound Through-Right	A	-	0	A	-	1
North Street at Drummond Street						
Eastbound Left-Through-Right	B	0.23	11	B	0.21	12
Westbound Left-Through-Right	B	0.35	12	B	0.45	14
Northbound Left-Through-Right	B	0.36	12	C	0.54	16
Southbound Left-Through-Right	C	0.57	15	C	0.67	20
Wilson Street at HWY. 7						
Eastbound Left-Through-Right	C	0.73	30	C	0.75	30
Westbound Left-Through-Right	B	0.60	19	B	0.55	14
Northbound Left-Through	D	0.74	37	D	0.65	36
Northbound Right	A	0.29	4	A	0.37	5
Southbound Left-Through	D	0.41	40	D	0.44	46
Southbound Right	A	0.25	9	B	0.29	11
Drummond Street at HWY. 7						
Eastbound Left-Through-Right	C	0.63	20	C	0.78	21
Westbound Left-Through	B	0.41	11	B	0.45	11
Westbound Right	A	0.02	2	A	*	*
Northbound Left	C	0.70	33	C	0.66	33
Northbound Through-Right	A	0.31	9	A	0.25	8
Southbound Left	B	0.05	18	C	0.04	20
Southbound Through-Right	A	0.30	10	A	0.19	9
Sunset Blvd at Wilson Street						
Eastbound Left-Through	C	0.47	21	C	0.48	24
Eastbound Right	A	0.42	5	A	0.40	6
Westbound Left-Through-Right	B	0.19	13	B	0.23	14
Northbound Left	A	0.23	7	A	0.29	8
Northbound Through-Right	B	0.43	11	B	0.59	14
Southbound Left	A	0.01	6	A	0.03	6
Southbound through	B	0.61	17	C	0.78	23
Southbound Right	A	0.08	1	A	0.09	1
Leslie Street/Isabella Street at Wilson Street						
Eastbound Left-Through-Right	B	0.13	15	C	0.53	27
Westbound Left-Through-Right	A	0.21	9	B	0.31	12
Northbound-Left	*	*	*	A	0.01	4
Northbound Through-Right	A	0.35	9	B	0.56	12
Southbound Left	A	0.06	4	A	0.08	4
Southbound Through-Right	A	0.41	6	B	0.73	14

"-" Vehicles move freely and no delays are present

\*\*\* No Vehicle was shown using this lane during the peak hour

All intersections are operating acceptable LOS of D or better during the AM Peak Hour and the PM Peak Hour, with minimal delay and queuing. During the site visit conducted by MP it was noticed that some queues were formed on the southbound leg of Wilson Street. The queues were observed to dissipate with each cycle of the signalized intersections.

### 5.3 Future Growth – Background Traffic Only

The following background traffic only scenarios take into account the annual 2.5% growth rate of traffic volumes at each intersection. The scenarios are developed assuming there are no changes to the road network, or signal timings. These scenarios serve as a baseline for comparison at the buildout year and horizon year, representing the case where there is no development built. Synchro outputs can be found in [Appendix E](#).

#### 5.3.1 Buildout Year (2030)

The majority of intersections operated at a LOS of D or better and a v/c below 0.9, with the exception of a few movements as noted in [Table 5.3.1](#). [Table 5.3.1](#) summarizes the 2030 Background Buildout Year traffic critical movements within the study area. Detailed Summary Tables can be found in [Appendix F](#).

Table 5.4 Background Buildout 2030 Critical Movements

Intersection	AM Peak Hour			PM Peak Hour		
	LOS	v/c Ratio	Total Delay (Sec)	LOS	v/c Ratio	Total Delay (Sec)
North Street at Wilson Street						
Eastbound Left-Through-Right				F	0.39	68.70
North Street at Drummond Street						
Northbound Left-Through-Right				E	0.86	38.10
Southbound Left-Through-Right				F	1.03	78.70
Wilson Street at HWY. 7						
Eastbound Left-Through-Right	E	1.01	65.40	F	1.10	89.40
Sunset Blvd at Wilson Street						
Southbound through				E	1.04	65.00
Leslie Street/Isabella Street at Wilson Street						
Eastbound Left-Through-Right				E	0.92	70.90

As seen in the table above all movements during the AM peak hour operate at satisfactory levels with the exception of the eastbound left-through-right turn movement at the intersection of Wilson Street and Highway 7 that operates at a LOS of E and a v/c of 1.01. During the PM peak hour there are multiple movements that operate at or above capacity or resulting in delays including:

- The intersection of North Street at Wilson Street the Eastbound left-through-right movement;
- The intersection of North Street at Drummond Street the Northbound left-through-right and Southbound left-through-right movements;
- The intersection of Wilson Street at Highway 7 The Eastbound left-through-right movements;
- The intersection of Sunset Boulevard at Wilson Street the Southbound through movement; and,

- The intersection of Wilson at Isabella Street the Eastbound left-through-right movement.

### 5.3.2 5 Year Horizon (2035)

The majority of intersections operated at a LOS of D or better and a v/c below 0.9, with the exception of a few movements as noted in Table 5.3.2. Table 5.3.2 summarizes the 2035 Background Horizon Year traffic critical movements within the study area. Detailed Summary Tables can be found in Appendix F.

Table 5.5 Background Horizon 2035 Critical Movements

Intersection	AM Peak Hour			PM Peak Hour		
	LOS	v/c Ratio	Total Delay (Sec)	LOS	v/c Ratio	Total Delay (Sec)
North Street at Wilson Street						
Eastbound Left-Through-Right	E	0.27	42.70	F	0.81	204.90
Westbound Left-Through-Right				F	0.82	68.20
North Street at Drummond Street						
Westbound Left-Through-Right				E	0.89	40.40
Northbound Left-Through-Right				F	1.10	16.20
Southbound Left-Through-Right	F	1.01	71.60	F	1.30	171.60
Wilson Street at HWY. 7						
Eastbound Left-Through-Right	F	1.26	160.30	F	1.35	192.30
Westbound Left-Through-Right	E	1.18	60.70	D	1.00	51.40
Northbound Left-Through	E	0.96	61.30			
Drummond Street at HWY. 7						
Eastbound Left-Through-Right				E	1.05	65.40
Northbound Left	F	1.01	87.60	E	0.88	56.10
Sunset Blvd at Wilson Street						
Northbound Through-Right				C	0.91	29.80
Southbound through				F	1.19	120.20
Leslie Street/Isabella Street at Wilson Street						
Eastbound Left-Through-Right				F	1.15	139.80
Southbound Through-Right				C	0.92	26.70

As seen in the table above many movements at 6 of the 8 study intersections begin to operate at or above capacity or showing delays during either the AM peak hour, PM peak hour or both. This includes:

- The eastbound and westbound left-through-right turn movements at the intersection of North Street and Wilson Street;
- The westbound, northbound and southbound approaches of the intersection of North Street and Drummond Street;
- The eastbound, westbound approaches and the northbound left-through movement at the intersection of Wilson Street and Highway 7;
- The eastbound approach and the northbound left turn movement at the intersection of Drummond Street and Highway 7;
- The northbound through-right and the southbound through movements at the intersection of Sunset Boulevard and Wilson Street; and,



- The eastbound approach and the southbound through-right turn movement at the intersection of Wilson Street and Isabella Street.

## 5.4 Future Conditions – Total Traffic

The following traffic scenarios take into account the 2.5% annual growth rate of the traffic volumes at each of the intersections as well as the trips generated by the proposed development. The scenarios are representative of the planned development at the buildout year and the horizon year. These scenarios take into account the addition of new trips, due to newly built residential units and roadway improvements, while leaving the signal timings unchanged. Synchro outputs are provided in [Appendix E](#).

### 5.4.1 Buildout Year (2030)

The majority of intersections operated at a LOS of D or better and a v/c below 0.9, with the exception of a few movements as noted in [Table 5.4.1](#). [Table 5.4.1](#) summarizes the 2030 Total Buildout Year traffic critical movements within the study area. Detailed Summary Tables can be found in [Appendix F](#).

Table 5.6 Total Buildout 2030 Critical Movements

Intersection	AM Peak Hour			PM Peak Hour		
	LOS	v/c Ratio	Total Delay (Sec)	LOS	v/c Ratio	Total Delay (Sec)
North Street at Wilson Street						
Eastbound Left-Through-Right				F	0.43	77.20
Westbound Left-Through-Right				E	0.61	35.90
North Street at Drummond Street						
Northbound Left-Through-Right				F	0.96	53.70
Southbound Left-Through-Right	E	0.85	38.50	F	1.11	106.30
Sunset Blvd at Wilson Street						
Southbound through				E	1.05	68.70
Leslie Street/Isabella Street at Wilson Street						
Eastbound Left-Through-Right				F	0.96	80.80

As seen in the table above all movements during the AM peak hour operate at satisfactory levels with the exception of:

- the southbound left-through-right turn movement at the intersection of North Street and Drummond Street that operates at a LOS of E and a v/c of 0.85.

During the PM peak hour there are multiple movements that operate at or above capacity or resulting in significant delays including:

- The intersection of North Street at Wilson Street, the Eastbound left-through-right and the Westbound left-through-right movement;
- The intersection of North Street at Drummond Street the Northbound left-through-right and Southbound left-through-right movements;
- The intersection of Sunset Boulevard and Wilson Street the Southbound-through movement; and,
- The intersection of Wilson at Isabella Street the Eastbound left-through-right movement.

It is shown that the improvements along Highway 7 no longer cause the intersections along the corridor of Highway 7 to operate at or above capacity or resulting in significant delays.

#### 5.4.2 5 Year Horizon (2035)

The majority of intersections operated at a LOS of D or better and a v/c below 0.9 with the exception of a few movements as noted in Table 5.4.12. Table 5.4.2 summarizes the 2035 Total Horizon Year traffic critical movements within the study area. Detailed Summary Tables can be found in Appendix F.

Table 5.7 Total Horizon 2035 Critical Movements

Intersection	AM Peak Hour			PM Peak Hour		
	LOS	v/c Ratio	Total Delay (Sec)	LOS	v/c Ratio	Total Delay (Sec)
North Street at Wilson Street						
Eastbound Left-Through-Right	E	0.29	45.60	F	0.90	248.50
Westbound Left-Through-Right				F	0.91	87.40
North Street at Drummond Street						
Westbound Left-Through-Right				F	1.01	55.70
Northbound Left-Through-Right				F	1.22	108.30
Southbound Left-Through-Right	F	1.06	88.60	F	1.39	197.80
Wilson Street at HWY. 7						
Northbound Left-Through	E	0.99	68.70			
Drummond Street at HWY. 7						
Northbound Left	E	0.94	57.90			
Sunset Blvd at Wilson Street						
Northbound Through-Right				C	0.91	30.50
Southbound through				F	1.20	124.90
Leslie Street/Isabella Street at Wilson Street						
Eastbound Left-Through-Right				F	1.19	155.10
Southbound Through-Right				C	0.92	27.00

As seen in the table above many movements at 6 of the 8 study intersections begin to operate at or above capacity or resulting in delays during either the AM peak hour, PM peak hour or both.

When comparing the two Horizon Year 2035 (Background to Total) scenarios we see an overall decrease in the number of critical traffic operations. This is the result of the roadway improvements along the Highway 7 corridor and the intersections along said corridor. However, apart from the two intersections along Highway 7, the overall traffic operates better at the Background Only Traffic scenario than during the Total Traffic scenario. However, the critical traffic operations are shown in both the background only scenarios and the total traffic scenarios alike, showing that the failures would be present regardless of the proposed development. Traffic operations may be further improved upon by the signalization of the two stop-controlled intersections, North Street and Wilson and North Street and Drummond Street, and the optimization of the signal timings of the existing signalized intersections.

## 6.0 MITIGATIONS

### 6.1 Signal Warrants

Traffic signal warrants were performed for the intersections of North Street at Drummond Street and for the intersection of North Street at Wilson Street. The warrant was performed using the 2020 existing conditions for North Street at Drummond Street. Traffic Signal Warrants were performed in accordance with Ontario Traffic Manual (OTM) Book 12 (Traffic Signals) methodology. Under existing conditions, the warrant for traffic signals was met at the intersection of North Street and Drummond Street without the addition of the development traffic.

The warrant was performed using the 2020 existing conditions for North Street at Wilson Street. Traffic Signal Warrants were performed in accordance with OTM Book 12 methodology. The warrant was not satisfied under 2020 existing conditions. Therefore, further warrants were performed for the buildout (2030) and horizon (2035) traffic scenarios for both background traffic and total traffic. Traffic Signal Warrants were performed in accordance with OTM Book 12 methodology. The warrant was not satisfied under 2030 or 2035 traffic scenarios. Therefore, a traffic signal at the intersection of North Street and Wilson Street is not warranted. The warrant calculations are provided in [Appendix G](#).

### 6.2 Signal Optimization: Total Traffic Horizon 2035

Traffic signal adjustments were performed at the intersections of Drummond Street and Highway 7, Wilson Street at Highway 7, Wilson Street at Sunset Boulevard and Wilson Street at Isabella Street. The signal adjustments were done with the built in Synchro 11 optimization function in order to improve traffic operations at each intersection. The adjustments were done on both the cycle length and the cycle split of the existing signal timings. Signal timing can be found in [Appendix G](#) within the Synchro 11 reports.

### 6.3 Traffic Operations with Mitigation Measures.

The following traffic scenarios take into account the 2.5% annual growth rate of the traffic volumes at each of the intersections as well as the trips generated by the proposed development. The scenarios are representative of the planned development at the horizon year with optimized signal timings as well as the intersection of Drummond Street at North Street being signalized and optimized in order to improve traffic operations throughout the network. All timing signals were optimized using Synchro 11 optimization feature. Synchro output reports as well as full summary tables can be found in [Appendix G](#).

[Table 6.3.1](#) illustrates the resulting critical movements.

Table 6.1 Total Traffic Horizon 2035 with Mitigation Critical Movements

Intersection	AM Peak Hour			PM Peak Hour		
	LOS	v/c Ratio	Total Delay (Sec)	LOS	v/c Ratio	Total Delay (Sec)
North Street at Wilson Street						
Eastbound Left-Through-Right	E	0.29	45.60	F	0.90	248.50
Westbound Left-Through-Right				F	0.91	87.40
Sunset Blvd at Wilson Street						
Eastbound Left-Through				E	0.86	65.20
Southbound through				D	0.95	38.90
Leslie Street/Isabella Street at Wilson Street						
Eastbound Left-Through-Right				F	0.93	83.80

As seen in the table above all intersections are operating at acceptable conditions during the AM Peak Hour with the exception of the eastbound left-through-right turn lane at the intersection of North Street and Wilson Street which operates at an LOS of E and a v/c of 0.29. During the PM Peak Hour, all movements at all intersections operate at satisfactory conditions with the except for the movements of the eastbound and westbound approaches at the intersection of North Street and Wilson Street, the eastbound left-through movement and the southbound through movement at the intersection of Sunset Boulevard and Wilson Street and the eastbound approach of the intersection of Leslie Street/Isabella Street at Wilson Street.

When comparing the critical operations during the mitigation scenario and the Horizon Year Total Traffic Only 2035 scenario we see that the scenario with mitigations has far less critical movements during the AM Peak Hour with only one being present, and seven less critical movements during the PM Peak Hour with only 5 movement operating at or above capacity or at significant delays.

It is seen that the uncritical operations for the traffic movements are present during both the Total Traffic scenarios as well as the Background Traffic scenarios. Therefore, mitigation measures should be considered regardless of the proposed development.

The above shows that optimization of the signal timings is not sufficient in mitigating all the critical operation for each movement. Therefore, intersection improvements such as; roadway widening, changes in lane configuration, and new auxiliary lanes should be considered in the future.



## 7.0 SUMMARY, RECOMMENDATIONS AND CONCLUSION

The findings and conclusions of this Traffic Impact Study for the proposed Perthmore Subdivision development in the Town of Perth is summarized as follows:

- The existing road network within the study are currently operates well with approaches are all intersections operating at a LOS of D or better, a v/c of 0.78 or less and a delay no more than 46 seconds.
- The proposed development is expected to generate 62 new vehicle trips during the AM Peak Hour, and 82 new vehicle trips in the PM Peak Hour at full buildout.
- The future horizon scenario is 2035, which includes the background traffic growth as well as the newly generated trips from the development and planned roadway modifications, is expected to have minimal impacts to the traffic operations of the adjacent network.
- When comparing the Total Traffic Scenario to the Background Traffic Only Scenario 2035 network there is a similar number of intersections and movements operating at or above capacity or resulting in significant delays during both the AM and PM Peak Hour
- With improvements to the Highway 7 corridor due to the planned roadway improvements, it is anticipated that the operations along the Highway 7 corridor will improve.
- Critical movements occurring are expected to be present in both the background only scenarios and the total traffic scenarios. The total traffic scenarios is the more critical having more critical movements and more critical traffic operations.

Based on the expected future traffic operations shown MP performed mitigation analysis to the traffic network. The results were as followed:

- Signal warrants were checked for the intersections of North Street at Drummond Street and North Street at Wilson Street. North Street at Drummond Street satisfied the warrant at 100% during the existing conditions. North Street at Wilson Street did not satisfy the warrant at 100% for existing conditions nor the 120% for the horizon year 2035. As such signalization is warranted solely at the intersection of North Street at Wilson Street.
- Existing signal timings were optimized using Synchro 11 software resulting in minimizing the number of critical movements during the total traffic 2035 Horizon year scenario.

MP Recommends consideration be given to changing the intersection control at the intersection of Drummond Street at North Street to traffic signals from all-way stop control, and to continue to monitor the intersection of Wilson Street at North Street for the potential for signalization.

Consideration should be giving to optimizing the signal timings of the signalized intersections along Wilson Street in order to prioritize the critical movements shown within this report. The existing traffic network operates at satisfactory conditions. As such, the mitigation measures mentioned are not expected to be required until 2030, however traffic operations/performance should be monitored. As the buildout year is 10 years away from the existing conditions, it is recommended that the traffic operations continue to be monitored and appropriate changes made to the network as required.

With the planned widening of Highway 7 between Wilson Street and Drummond Street, it is anticipated that this will reduce the traffic impact on the two intersections along the highway 7 corridor and the intersections will operate under improved conditions.

APPENDIX A – SITE PLAN

# DRAFT PLAN OF SUBDIVISION

OF  
PART OF THE NORTHEAST HALF LOT 3  
CONCESSION 2  
GEOGRAPHIC TOWNSHIP OF DRUMMOND  
NOW IN THE TOWN OF PERTH  
COUNTY OF LANARK

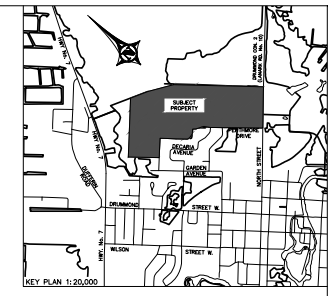

TO BE SUBDIVIDED INTO:  
LOTS 1,3,4,6,8,9,11,12,14,16,17,18,19,21,22,24,26,27,28,29,30,31,32,33,34,37,38,39,40,42,44,45,47,48,49 FOR SINGLE DETACHED RESIDENTIAL DWELLINGS  
FOR SEMI-DETACHED RESIDENTIAL DWELLINGS  
LOTS 2,5,7,10,13,15,20,23,25,35,36,41,43,46,50,51,52,53,  
FOR SEMI-DETACHED RESIDENTIAL DWELLINGS

BLOCK 54 FOR STORMWATER MANAGEMENT  
BLOCK 55 FOR STREET A CUL-DE-SAC  
BLOCK 56 FOR FUTURE STREET  
BLOCK 57 FOR PARLAND

STREET A - 20 METRES WIDE  
PERTHMORE STREET - 20 METRES WIDE  
SENATORS GATE DRIVE - 20 METRES WIDE

**APPLICANT AND PROPERTY OWNER**  
PERTHMORE ENTERPRISES INC.  
C/O MAURICE DECARIA  
P.O. BOX 20054  
PERTH, ON, R7H 3M6

**OWNER'S CERTIFICATE**  
I HEREBY AUTHORIZE THE PREPARATION AND SUBMISSION OF THIS PLAN TO THE COUNCIL OF THE COUNTY OF LANARK.

DATE August 5, 2022  
MAURICE DECARIA  
PERTHMORE ENTERPRISES INC.  
I HAVE AUTHORITY TO BIND THE CORPORATION

**SURVEYOR'S CERTIFICATE**  
I HEREBY CERTIFY THAT THE BOUNDARIES OF THE LANDS TO BE SUBDIVIDED AS SHOWN ON THIS PLAN AND THEIR RELATIONSHIP TO THE ADJOINING LANDS ARE ACCURATELY AND CORRECTLY SHOWN.

DATE August 5, 2022  
JOHN GAUTHIER, O.E.S.

**ADDITIONAL INFORMATION REQUIRED UNDER SECTION 51 (17) OF THE PLANNING ACT**

- A. AS SHOWN ON THE DRAFT PLAN
- B. AS SHOWN ON THE DRAFT PLAN
- C. AS SHOWN ON THE DRAFT PLAN
- D. AS DESCRIBED ON THE TITLE BLOCK
- E. AS SHOWN ON THE DRAFT PLAN
- F. AS SHOWN ON THE DRAFT PLAN
- G. AS SHOWN ON THE DRAFT PLAN
- H. PAVED MUNICIPAL WATER SUPPLY IS AVAILABLE TO SERVICE THE PROPERTY
- I. GENERALLY SANDY/SILT SOILS, WITH GRAVEL AND SHALLOW BEDROCK
- J. AS SHOWN ON THE DRAFT PLAN
- K. PAVED MUNICIPAL WATER AND WASTEWATER SERVICES ARE AVAILABLE TO SERVICE THE PROPERTY
- L. NO RESTRICTIONS APPLY

**SCHEDULE OF AREAS**

LOT/BLOCK	AREA (m <sup>2</sup> )	TYPE
1	488	SINGLE DETACHED
2	674	SEMI-DETACHED
3	472	SINGLE DETACHED
4	472	SINGLE DETACHED
5	673	SEMI-DETACHED
6	629	SINGLE DETACHED
7	665	SEMI-DETACHED
8	587	SEMI-DETACHED
9	588	SINGLE DETACHED
10	649	SEMI-DETACHED
11	482	SINGLE DETACHED
12	482	SINGLE DETACHED
13	675	SEMI-DETACHED
14	675	SEMI-DETACHED
15	675	SEMI-DETACHED
16	522	SINGLE DETACHED
17	674	SEMI-DETACHED
18	528	SINGLE DETACHED
19	528	SINGLE DETACHED
20	549	SEMI-DETACHED
21	482	SINGLE DETACHED
22	430	SINGLE DETACHED
23	430	SINGLE DETACHED
24	430	SINGLE DETACHED
25	675	SEMI-DETACHED
26	522	SINGLE DETACHED
27	524	SINGLE DETACHED
28	667	SEMI-DETACHED
29	703	SINGLE DETACHED
30	535	SINGLE DETACHED
31	596	SINGLE DETACHED
32	482	SINGLE DETACHED
33	547	SINGLE DETACHED
34	482	SINGLE DETACHED
35	482	SEMI-DETACHED
36	482	SEMI-DETACHED
37	482	SEMI-DETACHED
38	667	SINGLE DETACHED
39	535	SINGLE DETACHED
40	522	SINGLE DETACHED
41	671	SEMI-DETACHED
42	430	SINGLE DETACHED
43	430	SINGLE DETACHED
44	430	SINGLE DETACHED
45	482	SEMI-DETACHED
46	482	SEMI-DETACHED
47	482	SINGLE DETACHED
48	667	SINGLE DETACHED
49	667	SINGLE DETACHED
50	667	SINGLE DETACHED
51	649	SEMI-DETACHED
52	649	SEMI-DETACHED
53	649	SEMI-DETACHED
BLOCK 54	1,528	MEMORIAL DRIVE
BLOCK 55	4,178	STORMWATER
BLOCK 56	701	STREET A
BLOCK 57	278	FUTURE STREET
BLOCK 58	2,273	PARLAND
<b>TOTAL LOT/BLOCK AREA (m<sup>2</sup>)</b>	<b>41,299</b>	
<b>STREET</b>	<b>AREA (m<sup>2</sup>)</b>	<b>LENGTH (m)</b>
STREET A	10,007	500
PERTHMORE STREET	1,110	565
SENATORS GATE DRIVE	1,436	700
<b>TOTAL SUBDIVISION AREA (m<sup>2</sup>)</b>	<b>56,847</b>	

**BEARINGS & ELEVATIONS**  
BEARINGS ARE GRID BEARINGS DERIVED FROM REAL TIME NETWORK OBSERVATIONS, AND ARE REFERRED TO THE CENTRAL MERIDIAN OF NAD 83 ZONE 17U 30 WEST LONGITUDE NAD 83 (CSRS) (1997.0).  
ELEVATIONS AND TOPOGRAPHIC FEATURES SHOWN ON THIS PLAN HAVE BEEN DERIVED FROM DIGITAL IMAGERY FILES RECEIVED FROM THE ONTARIO MINISTRY OF NATURAL RESOURCES AND FORESTRY (MNRF) DATED 2019.

SCALE 1:500  
DISTANCES SHOWN ON THIS PLAN ARE IN METRES AND CAN BE CONVERTED TO FEET BY DIVIDING BY 3.048

**REVISIONS**

NO.	DESCRIPTION	DATE

**McINTOSH PERRY SURVEYING INC.**  
1348 Drummond St., 4th Fl., Perth, ON K7H 3J3  
Tel: 613-267-6524 Fax: 613-267-7992  
www.mcintoshperry.com

**PERTHMORE DEVELOPMENT**

DATE	ISSUE	PROJECT NO.	DRAWING NO.
JUNE 29, 2022	36" x 54"	1-500	19-4081
			01

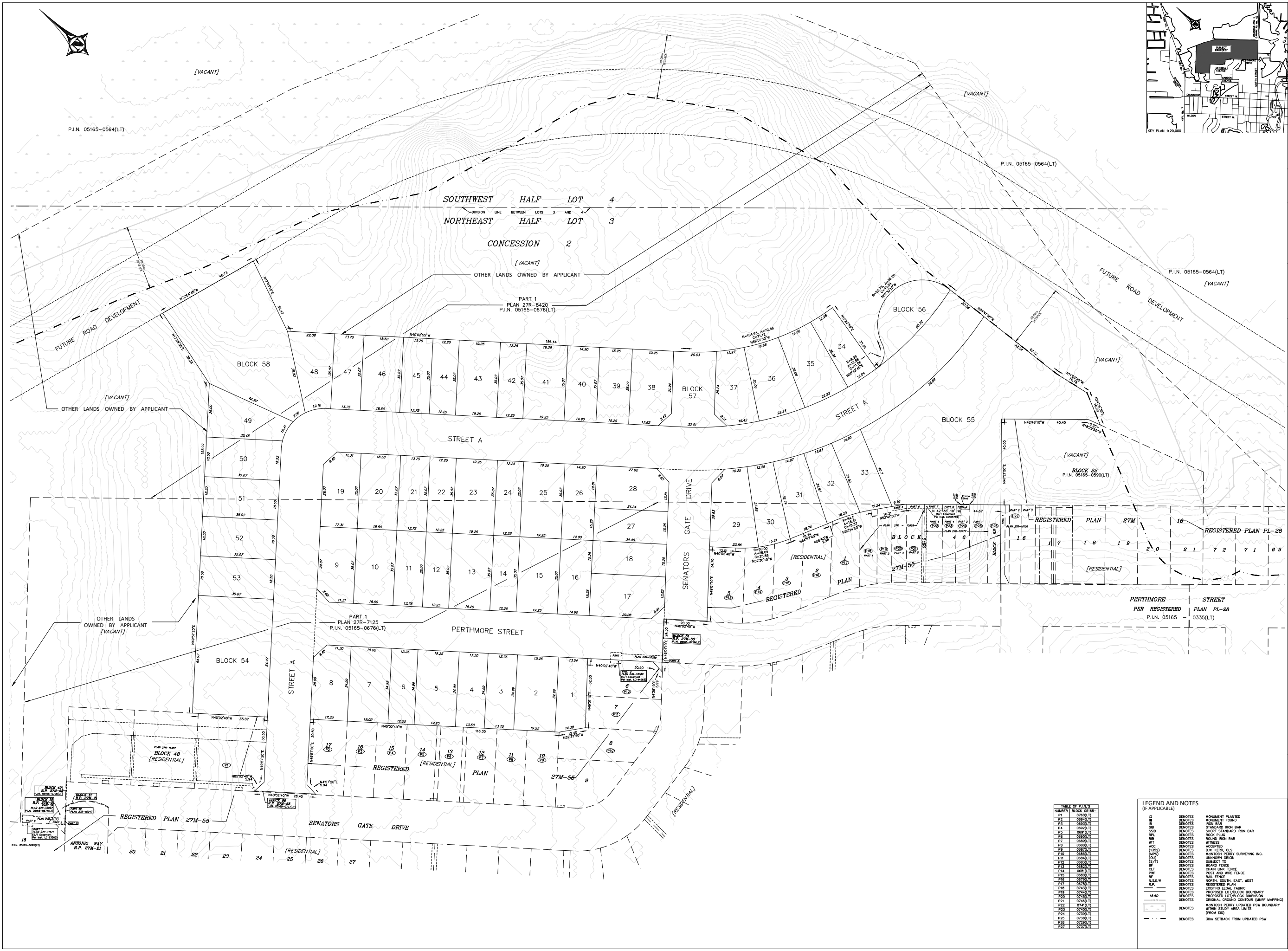
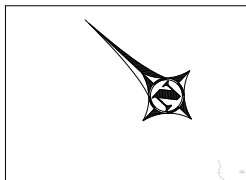

**TABLE OF P.I.N.'S**

NUMBER	BLOCK	DISTRICT
P1	0600(L)	
P2	0694(L)	
P3	0693(L)	
P4	0692(L)	
P5	0691(L)	
P6	0690(L)	
P7	0689(L)	
P8	0688(L)	
P9	0687(L)	
P10	0686(L)	
P11	0685(L)	
P12	0684(L)	
P13	0683(L)	
P14	0682(L)	
P15	0681(L)	
P16	0680(L)	
P17	0679(L)	
P18	0678(L)	
P19	0677(L)	
P20	0676(L)	
P21	0675(L)	
P22	0674(L)	
P23	0673(L)	
P24	0672(L)	
P25	0671(L)	
P26	0670(L)	
P27	0669(L)	

**LEGEND AND NOTES (IF APPLICABLE)**

- DENOTES MONUMENT PLANTED
- DENOTES MONUMENT FOUND
- DENOTES IRON BAR
- DENOTES STANDARD IRON BAR
- DENOTES SHORT STANDARD IRON BAR
- DENOTES ROCK PLUG
- DENOTES IRON ROD
- DENOTES WITNESS
- ACC. DENOTES ACCEPTED
- P(S) DENOTES S & K/KC, SLS
- (MPS) DENOTES MURTON PERRY SURVEYING INC.
- (O/S) DENOTES UNKNOWN ORIGIN
- (S/P) DENOTES SUBJECT TO
- DENOTES BOUNDARY
- CLF DENOTES CHAIN LINK FENCE
- DENOTES POST AND RAIL FENCE
- RF DENOTES RAIL FENCE
- N.S.E.W. DENOTES NORTH, SOUTH, EAST, WEST
- R.P. DENOTES REGISTERED PLAN
- DENOTES EXISTING LEGAL FABRIC
- DENOTES PROPOSED LOT/BLOCK BOUNDARY
- DENOTES PROPOSED LOT/BLOCK DIMENSION
- DENOTES ORIGINAL GROUND CONTOUR (MNR F.MAPPING)
- DENOTES McINTOSH PERRY UPDATED PSW BOUNDARY
- DENOTES M.T.W. STUDY AREA LIMITS
- DENOTES 30m SETBACK FROM UPDATED PSW





APPENDIX B – TOWN OF PERTH TRANSIT SCHEDULE



## ROUTE #502/503

Perth, Carleton Place, Almonte / Ottawa, Gatineau

**Effective Dec. 2nd, 2019 --- En vigueur le 2 décembre 2019**

Please arrive at the bus stop at least 5 minutes in advance. The bus may arrive earlier than scheduled.  
 Veuillez arriver à votre arrêt au moins 5 minutes avant l'heure prévue. L'autobus peut arriver plus tôt que prévu.

<b>DEPARTURE (A.M.) DÉPART (a.m.)</b>	
Perth - Giant Tiger	5:37
Perth - Hwy 7 / Leach Rd	5:42
Carleton Place - Townline Rd / Bridge St	6:00
Almonte - County Rd 29 / Rae Rd	6:05
Almonte - County Rd 29 / Scott St	6:07
Almonte - Bridge St @ Almonte Curling Rink	6:10
Almonte - Queen St / Clyde St (Co-operators)	6:14
Almonte - Ottawa St / March Rd (Shoppers Drug Mart)	6:15
<b>ARRIVAL/ARRIVÉE</b>	
Carling Ave @ Westgate Mall	6:45
Carling Ave / Holland Ave	6:47
Carling Ave / Parkdale Ave	6:48
Carling Ave @ Civic Hospital (main entrance)	6:49
Carling Ave / Preston St	6:51
Carling Ave / Booth St	6:52
Kent St / Laurier Ave	6:58
Slater St / Bank St	7:00
Slater St / Metcalfe St (Tim Horton's)	7:01
Gatineau, Place du Portage Phase IV (Maisonneuve)	7:10

<b>DEPARTURE (P.M.) DÉPART (p.m.)</b>	
Gatineau, Place du Portage Phase IV (Maisonneuve)	15:38
Albert St / Metcalfe St	16:00
Albert St / Bank St	16:02
Lyon St / Laurier Ave	16:04
Carling Ave / Preston St	16:12
Carling Ave @ Civic Hospital (OC Transpo shelter @ Inglewood)	16:17
Carling Ave @ Westgate Mall	16:20
<b>ARRIVAL/ARRIVÉE</b>	
Almonte - Ottawa St / March Rd (Shoppers Drug Mart)	17:00
Almonte - Queen St / Clyde St (Co-operators)	17:02
Almonte - Bridge St @ Almonte Curling Rink	17:04
Almonte - County Rd 29 / Scott St	17:06
Almonte - County Rd 29 / Rae Rd	17:08
Carleton Place - Bridge St / Townline Rd	17:14
Perth - Hwy 7 / Leach Rd	17:32
Perth - Giant Tiger	17:37

For more information / Plus plus d'information  
[www.classicalliancemotorcoach.com](http://www.classicalliancemotorcoach.com) | 613 253-3443 |  
[facebook.com/classicalliance](https://facebook.com/classicalliance)

## APPENDIX C – TRAFIC DATA

**Cover Sheet**

Location: Highway 7 at Wilson Street

Area/District: Ottawa

Timing Based On T.M. Dated: June 06, 2000

Traffic Signal # 243

Timing Developed By: K. Maki

Approved By: Paul Webster

Installed By: Paul Webster

Installation Date: \_\_\_\_\_

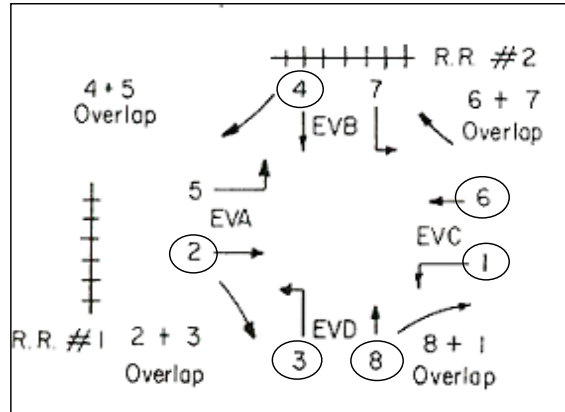

Circle Movements and Operations

**COMMUNICATIONS ADDRESSING**

COMM ADDRESS  
(C/0+0+0) = 1

CELL #: 416-985-9147

ZONE ADDRESS  
(C/0+0+1) = 1

UDP PORT: 8033

AREA NUMBER  
(C/0+0+2) = 4

IP ADDRESS: 10.151.192.6

AREA ADDRESS  
(C/0+0+3) = 243

AMPLIFIER:

PROGRAM: 233ON1.C

**DISABLE ALARM REPORTING**

		Column F							
		1	2	3	4	5	6	7	8
0	OMIT ALARMS					X			

< C + 0 + C = 5 >

- 1 = STOP TIME
- 2 = FLASH SENSE
- 3 = KEYBOARD ENTRY
- 4 = MANUAL PLAN SELECT
- 5 = ENABLE POLICE CNTRL (Not Used)
- 6 = EXTERNAL ALARM (Door Alarm)
- 7 = DETECTOR FAILURE



# ACTUATED INTERVAL TIMING AND FAZE FUNCTIONS

		PHASE							
		1	2	3	4	5	6	7	8
0	WALK		7		7		7		7
1	DON'T WALK		30		24		30		24
2	MIN INITIAL	7	20	7	10		20		10
3	TYPE 3 LIMIT								
4	ADD PER VEH		1.0				1.0		
5	VEH EXT	2.0	4.5	2.0	3.0		4.5		3.0
6	MAX GAP	2.0	4.5	2.0	3.0		4.5		3.0
7	MIN GAP	2.0	4.5	2.0	3.0		4.5		3.0
8	MAX LIMIT	14	30	14	15		30		15
9	MAXIMUM 2								
A	ADV /DLY WALK								
B	SEQUENCE TO	8		6					
C	COND SRV MIN								
D	REDUCE EVERY								
E	YELLOW	2.0	5.0	2.0	4.1		5.0		4.1
F	RED CLEAR		1.9		2.3		1.9		2.3

**PHASE BANK # 1 < C + O + F = 1 >**

		9	A	B	C	D	E
0							RR1 DLY
1	PHASE 1						RR1 CLR
2	PHASE 2	21					EVA DLY
3	PHASE 3						EVA CLR
4	PHASE 4						EVB DLY
5	PHASE 5						EVB CLR
6	PHASE 6	21					EVC DLY
7	PHASE 7						EVC CLR
8	PHASE 8						EVD DLY
							EVD CLR
							RR2 DLY
							RR2 CLR
							EV CLR
							EV DLY
							RR CLR
							RR DLY

ALL RED START  
( F/1 + C + O ) = **5.0**  
RED REVERT  
( F/1 + O + F ) = **5.0**

MAX ALT ALT ALT ALT  
INT WALK FLH INT EXT  
D/W

## COLUMN F PHASES

		1	2	3	4	5	6	7	8
0	PERMIT	X	X	X	X		X		X
1	RED LOCK								
2	YELLOW LOCK								
3	VEH MIN CALL		X				X		
4	PED RECALL								
5	PEDESTRIANS		X		X		X		X
6	YIELD AT FLSH D/W								
7	RED REST								
8	DOUBLE ENTRY		X		X		X		X
9	VEH MAX CALL								
A	SOFT RECALL								
B	MAXIMUM 2								
C	COND SERVICE								
D	MAN CONT CALL								
E	YELLOW START		X				X		
F	FIRST PHASES				X				X

**< C + O + F = 1 >**

**BI Tran Systems, Inc.**  
510 Bercut Dr., Sacramento, Calif. 95814  
916/441-0260  
Traffic Signal Program **233** Ontario  
Timing Sheet #2

**Date:** June 6, 2000

### LOCATION

Hwy: 7

At: \_\_\_\_\_

Wilson Street

	A	B	C
--	---	---	---

PREEMPT	RR1-2	SP	EMER
MINIMUMS	SPEV1	EV2	VEH

A	WLK (DFLT)		
B	FD WALK		
C	INITAL		

**< C + O + F = 1 >**

### Column E Phases / Bits

		1	2	3	4	5	6	7	8
0	EXCLUSIVE								
1	RR1 CLEAR								
2	RR2 CLEAR								
3	RR2 LTD SRV								
4	PROT/PERM	X		X					
5	FLH TO PREMT								
6	FLASH ENTRY								
7	DISABL MIN YEL	X		X					
8	DISABL OVP YEL								
9	OVP FLH YEL								
A	EM VEH A								
B	EM VEH B								
C	EM VEH C								
D	EM VEH D								
E	EXTRA 1	X		X					
F	IC SELECT		X						

**< C + O + E = 125 >**

### Column F Phases / Bits

		1	2	3	4	5	6	7	8
0									
1	EXT PERMIT 1								
2	EXT PERMIT 2								
3	EXCLU PED								
4									
5	PED 2P OUT		X						
6	PED 6P OUT						X		
7	PED 4P OUT				X				
8	PED 8P OUT								X
9	FLH YELLOW								
A									
B									
C									
D									
E	RESTRICTED								
F	EXTRA 2								

### Column F Phases / Bits

		1	2	3	4	5	6	7	8
0	ADV GRN FLH								
1	PHASE FLASH								
2	FLASH WALK								
3	GUAR PASS								
4	SIMUL GAP		X				X		
5	SEQ TIMING								
6	ADV WALK								
7	DELAY WALK								
8	EXT RECALL								
9									
A	MAX EXTEN								
B	INH PED RSRV								
C	SEMI ACTUATED								
D									
E	STRT VEH CALL	X	X	X	X		X		X
F	STRT PED CALL		X		X		X		X

**SPECIALS < C + O + F = 2 >**

MANUAL PLAN	
< C/O + A + 1 >	
MANUAL OFFSET	
< C/O + B + 1 >	

### MANUAL SELECTION

### MANUAL PLAN

- 0 = Automatic (Master)
- 9 = Control Plan 1 - 9
- 14 (E) = Free ( Isolated )
- 15 (F) = Software Flash

### MANUAL OFFSET

- 0 = Automatic (Master)
- 1 = Offset A
- 2 = Offset B
- 3 = Offset C

### FLASH TO PREEMPT

- 1 = EVA
- 2 = EVB
- 3 = EVC
- 4 = EVD
- 5 = RR1
- 6 = RR2
- 7 = SE1
- 8 = SE2
- 1 = TBC TYPE 1
- 2 = NEMA EXT. COORD.
- 3 = DAYLIGHT SAVINGS
- 4 =

### EXTRA 1

- 5 = EXPANDED STATUS REPORTING
- 6 = INTERNATIONAL PED
- 7 = CLEAR OUTPUTS DURING FLASH
- 8 = SPLIT RING

### EXTRA 2

- 1 = AWR ON DURING PHASE INITIAL
- 2 = LMU INSTALLED

### IC SELECT

- 2 = 2 WAY MODEM
- 3 = 7 WIRE SLAVE
- 4 = FLASH / FREE
- 5 = SIMPLEX MASTER
- 7 = 7 WIRE MASTER
- 8 = OFFSET INTURP

# Pretimed

	PHASE							
	1	2	3	4	5	6	7	8
WALK		7		7		7		7
DON'T WALK		30		24		30		24
MIN INTIAL	10	25	10	10		25		10
TYPE 3 LIMIT								
ADD PER VEH		1.5				2.0		
VEH EXT	2.0	4.5	2.0	3.0		4.5		3.0
MAX GAP	2.0	4.5	2.0	3.0		4.5		3.0
MIN GAP	2.0	4.5	2.0	3.0		4.5		3.0
MAX LIMIT		30		15		30		15
MAXIMUM 2								
ADV / DLY WALK								
SEQUENCE TO	8		6					
COND SRV MIN								
REDUCE EVERY								
YELLOW	2.0	5.0	2.0	4.1		5.0		4.1
RED CLEAR		1.9		2.3		1.9		2.3

PHASE BANK # < C + O + F = 1 >

		Column F PHASES							
		1	2	3	4	5	6	7	8
0	PERMIT	X	X	X	X		X		X
1	RED LOCK								
2	YELLOW LOCK								
3	VEH MIN CALL	X	X	X	X		X		X
4	PED RECALL		X		X		X		X
5	PEDESTRIANS								
6	REST IN WALK								
7	RED REST								
8	DOUBLE ENTRY		X		X		X		X
9	VEH MAX CALL								
A	SOFT RECALL								
B	MAXIMUM 2								
C	CORD SERVICE								
D	MAN CONT CALL								
E	YELLOW START		X				X		
F	FIRST PHASES				X				X

< C + O + F = 1 >

**LOCATION:** Highway 7 at Wilson Street

**Issued Date:**

**Installed Date:** June 6, 2000

**BI Tran Systems, Inc.**

510 Bercut Dr., Sacramento, Calif. 95814  
916/441-0260

Traffic Signal Program **233** Ontario

Timing Sheet #2

Revised (02/95)



# DETECTOR ASSIGNMENTS

STANDARD 332 CABINET LOCATION	column	1	3	Column 0	Column 1								Column 2								Column 3								DETECTOR ASSIGNMENT SHEET ONTARIO 233 PROGRAM						
			carry		ATTRIBUTES								PHASE(S)								ASSIGNMENTS														
		delay	over		C1 Pin #	1	2	3	4	5	6	7	8	1	2	3	4	5	6	7	8	1	2	3	4	5	6	7			8				
I-2 U	0			0 39				X	X		X		X							X	X	X					X	<b>LOCATION:</b> Hwy 7 at Wilson Street <b>Issued Date:</b> <b>Installed Date:</b> June 6, 2000 <b>DETECTOR ATTRIBUTES</b> 1 = FULL TIME DELAY 2 = PEDESTRIAN CALL 3 = 4 = COUNT 5 = EXTENSION 6 = TYPE 3 7 = CALLING 8 = ALTERNATE  <b>DETECTOR ASSIGNMENTS</b> 1 = DET. SET # 1 2 = DET. SET # 2 3 = DET. SET # 3 4 = 5 = 6 = MIN RECALL ON FAILURE 7 = MAX RECALL ON FAILURE 8 - REPORT ON FAILURE  <b>DETECTOR MONITOR</b> MAX OFF: D/0+0+1=120 MAX ON: D/0+0+2=60  <b>ADVANCE WARNING BEACONS</b> SIGN #1                      SIGN #2 PHASE NUMBER (F/1+C+F)=                  (F/1+D+F)= TIME BEFORE YELLOW (F/1+C+E)=                  (F/1+D+E)= OUTPUT PIN NUMBER (E/127+E+8)=                (E/127+E+9)=							
J-2 U	1			1 40				X	X		X						X		X	X	X					X									
I-6 U	2	3.0		2 41				X	X		X			X					X	X	X					X									
J-6 U	3	3.0		3 42				X	X		X							X	X	X	X					X									
I-2 L	4			4 43				X	X		X	X							X	X	X					X									
J-2 L	5			5 44				X	X		X						X		X	X	X					X									
I-6 L	6	10.0		6 45				X	X		X			X					X	X	X					X									
J-6 L	7	10.0		7 46				X	X		X							X	X	X	X					X									
I-4	8			8 47																															
J-4	9			9 48																															
I-8	A			A 49																															
J-8	B			B 50																															
J-1	C			C 55																															
I-1	D	10.0		D 56				X	X		X	X							X	X	X					X									
J-5	E			E 57																															
I-5	F			F 58																															
< C + O + D = 0 >				DETECTOR ASSIGNMENTS < C + O + E = 126 >																															
STANDARD 332 CABINET LOCATION	column	2	4	Column 4	Column 5								Column 6								Column 7														
			carry		ATTRIBUTES								PHASE(S)								ASSIGNMENTS														
		delay	over		C1 Pin #	1	2	3	4	5	6	7	8	1	2	3	4	5	6	7	8	1	2	3	4	5	6	7	8						
J-9 U	0			0 59																															
I-9 U	1			1 60																															
I-9 L	2			2 61																															
J-9 L	3			3 62																															
I-3 U	4			4 63																															
J-3 U	5			5 64																															
I-7 U	6			6 65																															
J-7 U	7			7 66																															
I-12 U	8			8 67			X						X					X	X	X															
I-13 U	9			9 68			X									X		X	X	X															
I-12 L	A			A 69			X							X				X	X	X															
I-13 L	B			B 70			X											X	X	X															
I-3 L	C			C 76																															
J-3 L	D			D 77																															
I-7 L	E			E 78																															
J-7 L	F			F 79																															
< C + O + D = 0 >				DETECTOR ASSIGNMENTS < C + O + E = 126 >																															



# Input File Layout

Input File Slot No. →

	1	2	3	4	5	6	7	8	9	10	11	12	13	14
<b>"I" FILE</b>	<b>1</b> Ext. Cnt, Call <C1-56>	<b>2</b> Ext. Cnt, Call <C1-39>	<b>2</b> Ext. Cnt, Call <C1-63>	<b>2</b> Type 3, Call <C1-47>	<b>3</b> Ext. Cnt, Call <C1-58>	<b>4</b> Ext. Cnt, Call <C1-41>	<b>4</b> Ext. Cnt, Call <C1-65>	<b>4</b> Type 3, Call <C1-49>	<b>1</b> Ext. Cnt, Call <C1-60>	NOT WIRED	Door Alarm <C1-80>	<b>2</b> Ped Call <C1-67>	<b>6</b> Ped Call <C1-68>	Flash Sense <C1-81>
		<b>2</b> Ext. Cnt, Call <C1-43>	<b>2</b> Ext. Cnt, Call <C1-76>			<b>4</b> Ext. Cnt, Call <C1-45>	<b>4</b> Ext. Cnt, Call <C1-78>		<b>3</b> Ext. Cnt, Call <C1-62>		Not Assigned <C1-53>	<b>4</b> Ped Call <C1-69>	<b>8</b> Ped Call <C1-70>	Stop Time <C1-82>

**DETECTOR TYPES**

Ext = Extension Detector  
Detector is only active during the Phase's GREEN Intervals (ie, will NOT Call the Phase)

Cnt = Count Detector  
Used in computing "Added Initial"

Call = Calling Detector  
Detector is only active during the Phase's NON-GREEN Intervals (ie, will NOT Extend the Phase)

Type 3 = Type 3 Disconnect  
Will allow a Calling Detector to Extend its Phase until the Call first drops or the "Type 3 Limit" is reached

**"J" FILE**

	5	6	6	6	7	8	8	8	5	NOT WIRED	Not Assigned <C1-54>	EV A Preempt <C1-71>	EV B Preempt <C1-72>	Railroad 1 <C1-51>
	Ext. Cnt, Call <C1-55>	<b>6</b> Ext. Cnt, Call <C1-40>	<b>6</b> Ext. Cnt, Call <C1-64>	<b>6</b> Type 3, Call <C1-48>	<b>7</b> Ext. Cnt, Call <C1-57>	<b>8</b> Ext. Cnt, Call <C1-42>	<b>8</b> Ext. Cnt, Call <C1-66>	<b>8</b> Type 3, Call <C1-50>	<b>5</b> Ext. Cnt, Call <C1-59>		Not Assigned <C1-75>	EV C Preempt <C1-73>	EV D Preempt <C1-74>	Railroad 2 <C1-52>
		<b>6</b> Ext. Cnt, Call <C1-44>	<b>6</b> Ext. Cnt, Call <C1-77>			<b>8</b> Ext. Cnt, Call <C1-46>	<b>8</b> Ext. Cnt, Call <C1-79>		<b>7</b> Ext. Cnt, Call <C1-61>					

**BI Tran Systems, Inc.**  
 510 Bercut Dr., Sacramento, Calif. 95814  
 916/441-0260  
 Traffic Signal Program 233  
 Initialized Detector Assignments  
 (Revised 8/92) 332 Cabinet

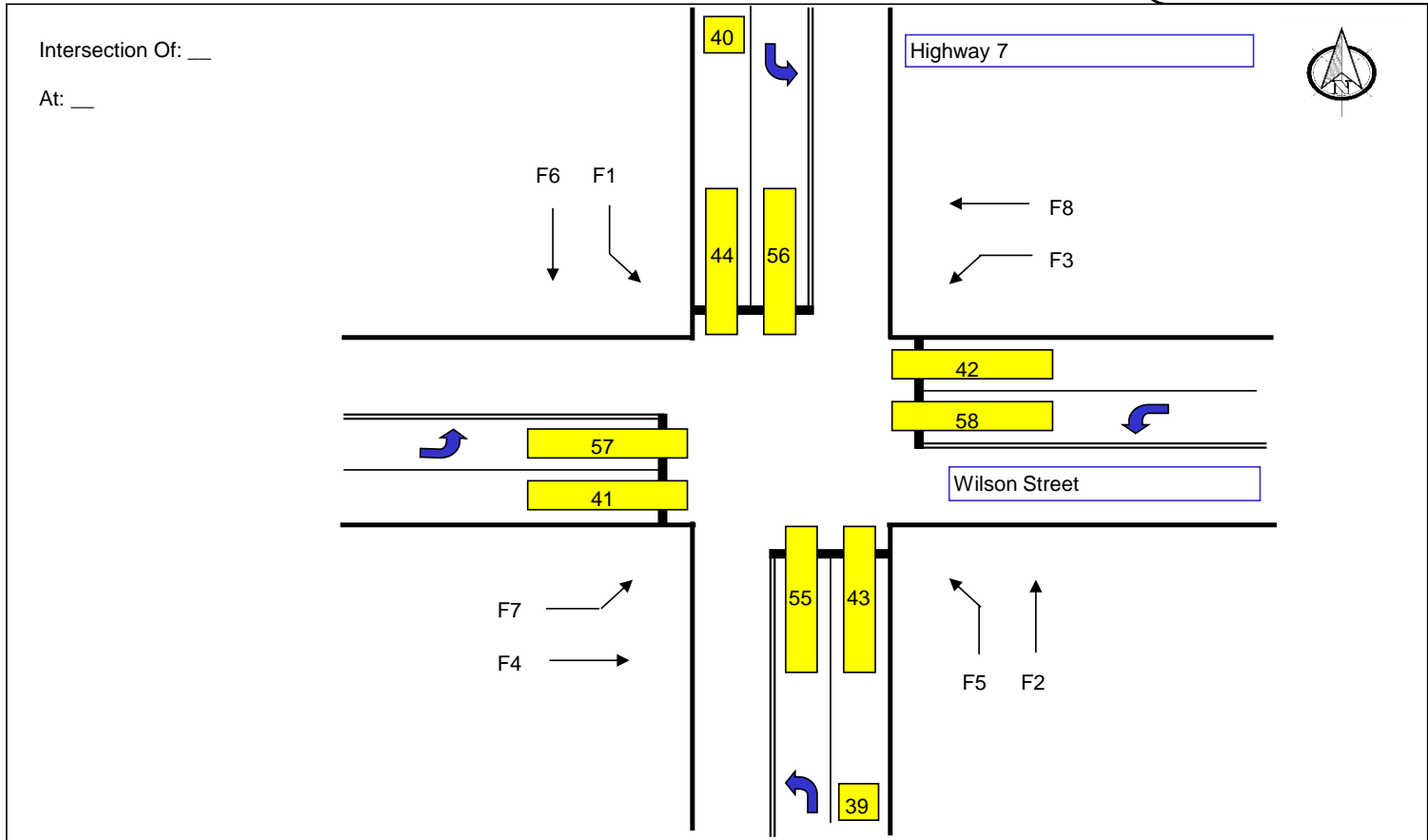

# OVERLAPS AND AAWS

		PED/PHASE/OVERLAP							
		1	2	3	4	5	6	7	8
0	WALK								
1	DON'T WALK								
2	PHASE GREEN								
3	PHASE AMBER								
4	PHASE RED								
5	OVERLAP GREEN								
6	OVERLAP AMBER								
7	OVERLAP RED								

**REDIRECT PHASE OUTPUTS** (C + 0 + E = 127)

Enable/Disable  
Phase Redirection

CABINET TYPE :  
(E/125 + D + 0) = 0 ( For 332 cabinet )  
(enable redirection = 30 )

PROGRAMMING OVERLAP SETS		
ASSIGNABLE INPUTS	OVERLAP SET 1	No Programming Required
	OVERLAP SET 2	E/126 + D + C = _____
	OVERLAP SET 3	E/126 + D + D = _____

DATE: \_\_\_\_\_

LOCATION: \_\_\_\_\_

**BI Tran Systems, Inc.**  
510 Bercut Dr., Sacramento, Calif. 95814  
916/441-0260  
Traffic Signal Program **233** Ontario  
Timing Sheet #2

		1								2								3								4							
		1	2	3	4	5	6	7	8	1	2	3	4	5	6	7	8	1	2	3	4	5	6	7	8	1	2	3	4	5	6	7	8
0	LOAD SW #																																
1	VEH SET 1																																
2	VEH SET 2																																
3	VEH SET 3																																
4	NEG VEH																																
5	NEG PED																																
6	GREEN OMIT																																
7	GRN CLR OMIT																																

D	GREEN CLEAR								
E	AMBER CLEAR								
F	RED CLEAR								

**OVERLAP ASSIGNMENTS** (C + 0 + E = 29)

**ADVANCE WARNING FLASHERS**

Time Before Amber	0.0	< F/1+C+E >
Phase Number	0	< F/1+C+F >
Output Pin Number		< E/127+E+8 >

**Advance Warning Beacon - Sign #1**

Time Before Amber	0.0	< F/1+D+E >
Phase Number	0	< F/1+D+F >
Output Pin Number		< E/127+E+9 >

**Advance Warning Beacon - Sign #2**



**COORDINATION**

		PLAN								
Column Numbers ---->		1	2	3	4	5	6	7	8	9
Row	Plan Name ---->									
0	Cycle Length	0	0	0	0	0	0	0	0	0
1	Phase 1 - ForceOff	0	0	0	0	0	0	0	0	0
2	Phase 2 - ForceOff	0	0	0	0	0	0	0	0	0
3	Phase 3 - ForceOff	0	0	0	0	0	0	0	0	0
4	Phase 4 - ForceOff	0	0	0	0	0	0	0	0	0
5	Phase 5 - ForceOff	0	0	0	0	0	0	0	0	0
6	Phase 6 - ForceOff	0	0	0	0	0	0	0	0	0
7	Phase 7 - ForceOff	0	0	0	0	0	0	0	0	0
8	Phase 8 - ForceOff	0	0	0	0	0	0	0	0	0
9	Ring Offset	0	0	0	0	0	0	0	0	0
A	Offset 1	0	0	0	0	0	0	0	0	0
B	Offset 2	0	0	0	0	0	0	0	0	0
C	Offset 3	0	0	0	0	0	0	0	0	0
D	Perm 1 - End	0	0	0	0	0	0	0	0	0
E	Hold Release	255	255	255	255	255	255	255	255	255
F	Zone Offset	0	0	0	0	0	0	0	0	0

Coordination - Bank 1 <C+0+C=1>

Row										
0	Ped Adjustment	0	0	0	0	0	0	0	0	0
1	Perm 2 - Start	0	0	0	0	0	0	0	0	0
2	Perm 2 - End	0	0	0	0	0	0	0	0	0
3	Perm 3 - Start	0	0	0	0	0	0	0	0	0
4	Perm 3 - End	0	0	0	0	0	0	0	0	0
5	Reservice Time	0	0	0	0	0	0	0	0	0
6	Reservice Phases									
7										
8	Pretimed Phases									
9	Max Recall									
A	Perm 1 Veh Phase	1_345_7	1_345_7	1_345_7	1_345_7	1_345_7	1_345_7	1_345_7	1_345_7	1_345_7
B	Perm 1 Ped Phase	1_345_7	1_345_7	1_345_7	1_345_7	1_345_7	1_345_7	1_345_7	1_345_7	1_345_7
C	Perm 2 Veh Phase									
D	Perm 2 Ped Phase									
E	Perm 3 Veh Phase									
F	Perm 3 Ped Phase									

Coordination - Bank 2 <C+0+C=2>

Row		2
1	Phase 1	10
2	Phase 2	10
3	Phase 3	10
4	Phase 4	10
5	Phase 5	10
6	Phase 6	10
7	Phase 7	10
8	Phase 8	10

Coordination Transition  
Minimums < C+0+C = 5 >

Transition Type  < C/5+1+9 >  
**TBC TRANSITION**

Lag Hold Phases  < C/5+1+A >  
**Coordinated Lag Hold Phases**

Sync Output Time  < C/5+1+C >  
**7 - Wire Master**

Transition Type  
0.X = Shortway  
1.X = Lengthen  
X.1 thru X.4 = # of cycles  
when lengthening

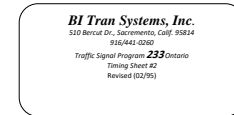

DATE:

03-Sep-12

LOCATION:

(Coord Extra Bit 1 = Programmed WALK Time for Sync Phases)

Row	E	Row	Time	Plan	Offset	Day of Week
		0	0:00	0	0	
Plan 1 - Sync	2_6_	1	0:00	0	0	
Plan 2 - Sync	2_6_	2	0:00	0	0	
Plan 3 - Sync	2_6_	3	0:00	0	0	
Plan 4 - Sync	2_6_	4	0:00	0	0	
Plan 5 - Sync	2_6_	5	0:00	0	0	
Plan 6 - Sync	2_6_	6	0:00	0	0	
Plan 7 - Sync	2_6_	7	0:00	0	0	
Plan 8 - Sync	2_6_	8	0:00	0	0	
Plan 9 - Sync	2_6_	9	0:00	0	0	
NEMA Sync		A	0:00	0	0	
NEMA Hold		B	0:00	0	0	
		C	0:00	0	0	
		D	0:00	0	0	
Coord Extra	#NAME?	E	0:00	0	0	
		F	0:00	0	0	

Sync Phases < C+0+C = 1 >

TOD Coordination < C+0+9 = 0.1 >  
( Bank 1 )

Row	F	Row	Time	Plan	Offset	Day of Week
Free Lag	2_4_6_8	0	0:00	0	0	
Plan 1 - Lag	2_4_6_8	1	0:00	0	0	
Plan 2 - Lag	2_4_6_8	2	0:00	0	0	
Plan 3 - Lag	2_4_6_8	3	0:00	0	0	
Plan 4 - Lag	2_4_6_8	4	0:00	0	0	
Plan 5 - Lag	2_4_6_8	5	0:00	0	0	
Plan 6 - Lag	2_4_6_8	6	0:00	0	0	
Plan 7 - Lag	2_4_6_8	7	0:00	0	0	
Plan 8 - Lag	2_4_6_8	8	0:00	0	0	
Plan 9 - Lag	2_4_6_8	9	0:00	0	0	
External Lag		A	0:00	0	0	
		B	0:00	0	0	
		C	0:00	0	0	
		D	0:00	0	0	
		E	0:00	0	0	
		F	0:00	0	0	

Lag Phases < C+0+C=1 >

TOD Coordination < C+0+9 = 0.2 >  
( Bank 2 )

Assignable Inputs&Outputs

	Column A		Column B		Column C		Column D		Column E		Column F		
0	NOT 3	0	MAX 2	0	PRETIME	0	WEEKDAY	0	DIAL 2	0		0	0
1	NOT 4	0	SYSDET 1	0	PLAN 1	0	X PERM 1	0	DIAL 3	0	EVA	71	1
2	OR 4	0	SYSDET 2	0	PLAN 2	0	X PERM 2	0	OFFSET 1	0	EVB	72	2
3	OR 4	0	SYSDET 3	0	PLAN 3	0	DIM	0	OFFSET 2	0	EVC	73	3
4	OR 5	0	SYSDET 4	0	PLAN 4	0	X CLOCK	0	OFFSET 3	0	EVD	74	4
5	OR 5	0	SYSDET 5	0	PLAN 5	0	STOP TIME	82	FREE	0	RR 1	51	5
6	OR 6	0	SYSDET 6	0	PLAN 6	0	FL SENSE	81	FLASH	0	RR 2	52	6
7	OR 6	0	SYSDET 7	0	PLAN 7	0	ENABLE	0	XPED OMIT	0	SP EVNT 1	0	7
8		0	SYSDET 8	0	PLAN 8	0	ADVANCE	0	NOT 1	0	SP EVNT 2	0	8
9		0	MAX INBT	0	PLAN 9	0	ALARM	80	NOT 2	0	EXT LAG	0	9
A	AND 4	0	FORCE A	0	DELAY A	0	PH BNK 2	0	OR 1	0	AND 1	0	A
B	AND 4	0	FORCE B	0	DELAY B	0	PH BNK 3	0	OR 1	0	AND 1	0	B
C	NAND 1	0	C NA	0	DELAY C	0	OLAP SET 2	0	OR 2	0	AND 2	0	C
D	NAND 1	0	HOLD	0	DELAY D	0	OLAP SET 3	0	OR 2	0	AND 2	0	D
E	NAND 2	0	VE CALL	0	DELAY E	0	DET SET 2	0	OR 3	0	AND 3	0	E
F	NAND 2	0	RECALL	0	DELAY F	0	DET SET 3	0	OR 3	0	AND 3	0	F

ASSIGNABLE INPUTS < C + O + E = 126>

	Column A		Column B		Column C		Column D		Column E		Column F		
0		0	FLASHER 0	0	FREE	0	NOT 1	0	TOD 1	0	DIAL 2	0	0
1	SP EV 1	0	FLASHER 1	0	PLAN 1	0	OR 1	0	TOD 2	0	DIAL 3	0	1
2	SP EV 2	0	FAST FLSHR	0	PLAN 2	0	OR 2	0	TOD 3	0	OFFSET 1	0	2
3	SP EV 3	0		0	PLAN 3	0	OR 3	0	TOD 4	0	OFFSET 2	0	3
4	SP EV 4	0		0	PLAN 4	0	AND 1	0	TOD 5	0	OFFSET 3	0	4
5	SP EV 5	0		0	PLAN 5	0	AND 2	0	TOD 6	0	FREE	0	5
6	SP EV 6	0		0	PLAN 6	0	AND 3	0	TOD 7	0	FLASH	0	6
7	SP EV 7	0		0	PLAN 7	0	NOT 2	0	TOD 8	0	PREEMPT	0	7
8	SP EV 8	0	NOT 3	0	PLAN 8	0	EVA	0	WARN 1	0		231	8
9		0	NOT 4	0	PLAN 9	0	EVB	0	WARN 2	0		232	9
A	DET FAIL	0	OR 4	0		0	EVC	0	DEALY A	0		233	A
B		0	OR 5	0		0	EVD	0	DELAY B	0		234	B
C		0	OR 6	0		0	RR1	0	DELAY C	0		235	C
D	CENT. CTRL	0	AND 4	0		0	RR2	0	DELAY D	0		236	D
E	EXCL FDW	0	NAND 1	0		0	SP EVNT 1	0	DELAY E	0		233	E
F	EXCL WALK	0	NAND 2	0		0	SP EVNT 2	0	DELAY F	0		238	F

ASSIGNABLE OUTPUTS < C + O + E = 127>



# DEFAULT DETECTOR ASSIGNMENTS

Standard 332 Cabinet Location	Column 0	Column 1 ATTRIBUTES								Column 2 PHASE(S)								Column 3 ASSIGNMENTS							
	C1 PIN NUMBER	1	2	3	4	5	6	7	8	1	2	3	4	5	6	7	8	1	2	3	4	5	6	7	8
		I-2 U	0	39		X	X	X		X									X	X	X				
J-2 U	1	40		X	X	X							X				X	X	X					X	
I-6 U	2	41		X	X	X							X				X	X	X					X	
J-6 U	3	42		X	X	X										X	X	X	X					X	
I-2 L	4	43		X	X	X		X									X	X	X					X	
J-2 L	5	44		X	X	X							X				X	X	X					X	
I-6 L	6	45		X	X	X							X				X	X	X					X	
J-6 L	7	46		X	X	X										X	X	X	X					X	
I-4	8	47			X	X		X								X	X	X						X	
J-4	9	48			X	X							X				X	X	X					X	
I-8	A	49			X	X							X				X	X	X					X	
J-8	B	50			X	X										X	X	X	X					X	
J-1	C	55			X	X	X						X				X	X	X					X	
I-1	D	56			X	X	X	X									X	X	X					X	
J-5	E	57			X	X	X									X	X	X	X					X	
I-5	F	58			X	X	X						X				X	X	X					X	

"INITIALIZED" DETECTOR ASSIGNMENTS  
< C + 0 + E = 126 >

Standard 332 Cabinet Location	Column 4	Column 5 ATTRIBUTES								Column 6 PHASE(S)								Column 7 ASSIGNMENTS							
	C1 PIN NUMBER	1	2	3	4	5	6	7	8	1	2	3	4	5	6	7	8	1	2	3	4	5	6	7	8
		J-9 U	0	59			X	X	X									X							
I-9 U	1	60			X	X	X	X								X								X	
J-9 L	2	61			X	X	X								X									X	
I-9 L	3	62			X	X	X							X										X	
I-3 U	4	63			X	X	X							X										X	
J-3 U	5	64			X	X	X							X										X	
I-7 U	6	65			X	X	X							X										X	
J-7 U	7	66			X	X	X									X								X	
I-12 U	8	67	X											X										X	
I-13 U	9	68	X											X										X	
I-12 L	A	69	X											X										X	
I-13 L	B	70	X													X								X	
I-3 L	C	76			X	X	X							X										X	
J-3 L	D	77			X	X	X							X										X	
I-7 L	E	78			X	X	X							X										X	
J-7 L	F	79			X	X	X									X								X	

"INITIALIZED" DETECTOR ASSIGNMENTS  
< C + 0 + E = 126 >

**DETECTOR ATTRIBUTES**

- 1= Full time Delay
- 2= Pedestrian call
- 3=
- 4= Count
- 5= Extension
- 6= Type 3
- 7= Calling
- 8= Alternate

**DETECTOR ASSIGNMENTS**

- 1 = Det. Set #1
- 2 = Det. Set #2
- 3 = Det. Set #3
- 4 =
- 5 =
- 6 = MIN Recall On Failure
- 7 = MAX Recall On Failure
- 8 = Report On Failure

**DETECTOR TYPES**

- Ext = Extension Detector  
Detector is only active during the Phase's GREEN Intervals (ie, will NOT Call the Phase)
- Cnt = Count Detector  
Used in computing "Added Initial"
- Call = Calling Detector  
Detector is only active during the Phase's NON-GREEN Intervals (ie, will NOT Extend the Phase)
- Type 3 = Type 3 Disconnect  
Will allow a Calling Detector to Extend its Phase until the Call first drops or the "Type 3 Limit" is reached

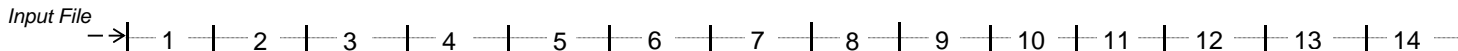

**"I" FILE**

1 Ext, Cnt, Call <C1-56>	2 Ext, Cnt, Call <C1-39>	2 Ext, Cnt, Call <C1-63>	2 Type 3, Call <C1-47>	3 Ext, Cnt, Call <C1-58>	4 Ext, Cnt, Call <C1-41>	4 Ext, Cnt, Call <C1-65>	4 Type 3, Call <C1-49>	NOT WIRED	1 Ext, Cnt, Call <C1-60>	Not Assigned <C1-80>	2 Ped Call <C1-67>	6 Ped Call <C1-68>	Flash Sense <C1-81>
	2 Ext, Cnt, Call <C1-43>	2 Ext, Cnt, Call <C1-76>			4 Ext, Cnt, Call <C1-45>	4 Ext, Cnt, Call <C1-78>			3 Ext, Cnt, Call <C1-53>	Not Assigned <C1-53>	4 Ped Call <C1-69>	8 Ped Call <C1-82>	Stop Time <C1-82>

**"J" FILE**

5 Ext, Cnt, Call <C1-55>	6 Ext, Cnt, Call <C1-40>	6 Ext, Cnt, Call <C1-64>	6 Type 3, Call <C1-48>	7 Ext, Cnt, Call <C1-57>	8 Ext, Cnt, Call <C1-42>	8 Ext, Cnt, Call <C1-66>	8 Type 3, Call <C1-50>	NOT WIRED	5 Ext, Cnt, Call <C1-59>	Not Assigned <C1-54>	EV A Preempt <C1-71>	EV B Preempt <C1-72>	Railroad 1 <C1-51>
	6 Ext, Cnt, Call <C1-44>	6 Ext, Cnt, Call <C1-77>			8 Ext, Cnt, Call <C1-46>	8 Ext, Cnt, Call <C1-79>			7 Ext, Cnt, Call <C1-61>	Not Assigned <C1-75>	EV C Ped Call <C1-73>	EV D Preempt <C1-74>	Railroad 2 <C1-52>

**BI Tran Systems, Inc.**  
 510 Bercut Dr., Sacramento, Calif. 95814  
 916/441-0260  
 Traffic Signal Program 233  
 Initialized Detector Assignments  
 (Revised 8/92) 332 Cabinet

# REFERENCE SHEET

## Controller Intervals

0 = Walk	8 = Red Rest
1 = FDW	9 = Preemption
2 = Min. Green	A = Stop Time
3 =	B = Red Revert
4 = Var. Initial	C = Yellow-Gap Termination
5 = Extension	D = Yellow-Max. Termination
6 =	E = Yellow-Forceoff Termination
7 = Reduce Gap	F = Red Clearance

## Continuous Memory Error Monitoring

The controller's RAM and EPROM memories are continuously checked for errors. If an error is found, the intersection will go into FLASH (via Watch Dog Timer), and one of the following will be shown on the controller's display:

- bAd A = An error was detected in the CPU's RAM, or a new program has been installed on the memory module.  
Often caused by a bad controller "gel-cell" battery.
- bAd b = An error was detected in the memory module's RAM.  
Often caused by a bad "lithium" battery on the memory module.
- bAd E = An error was detected in the 233 Program EPROM.
- bAd F = An error was detected in the Z-RAM (Dallas chip) on the memory module.

## 412/C Memory Module

### Lithium Battery Condition

To check the condition of the 3.6 volt Lithium Battery on the 412/C Memory Module:

- If  $E/112 + 0 + A = 84$  - the battery is BAD
- If  $E/112 + 0 + A = 85$  - the battery is O.K.

### Monitor "Activate" Flags

(Also Requires T.O.D. Function "E" Flag)  
Detector Count Recording:  
 $E/2 + 0 + 9 =$  Not Zero  
Real Time Split Monitor:  
 $E/2 + 0 + E =$  Not Zero

**E Page Enable:  $F/1 + 9 + E =$  Not Zero**

## Display Movement Codes

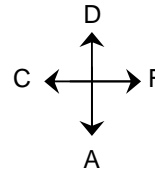

A = Advance ROW  
D = Decrement ROW  
C = COLUMN Back  
F = Forward COLUMN

## Special Event Schedules

Special Event #1:  $C + 0 + E = 27$   
Special Event #2:  $C + 0 + E = 28$

Current Interval =  $E + 5 + 0$   
Current Interval Timer =  $E + 5 + B$   
Current Interval Clearance Phases =  $E + 5 + C$

## Time of Day Function (7 Key)

Current T.O.D. "E Function"  
Control Bits =  $C/0 + E + E$   
Current T.O.D. "F Function"  
Output Bits =  $C/0 + E + F$

## Logic DELAY Gate

### Delay Timer Display

DELAY A Timer =  $C/0 + 9 + A$   
DELAY B Timer =  $C/0 + 9 + B$   
thru thru  
DELAY F Timer =  $C/0 + 9 + F$

## Interval Timer Display

Ring A =  $F/0 + A +$  Interval Row  
Ring B =  $F/0 + B +$  (Interval Row From PHASE BANK data)

## Display Locations

Plan Select      Offset Select

Manual =  $C/0 + A + 1$        $C/0 + B + 1$   
Master =  $C/0 + A + 2$        $C/0 + B + 2$   
Current =  $C/0 + A + 3$        $C/0 + B + 3$   
Next =  $C/0 + A + 4$        $C/0 + B + 4$   
TOD =  $C/0 + A + 5$        $C/0 + B + 5$   
Master Cycle =  $C/0 + A + 0$   
Ring A Cycle =  $C/0 + B + 0$   
Ring B Cycle =  $C/0 + D + 0$

MIN Cycle =  $C/0 + A + E$   
MAX Cycle =  $C/0 + B + E$

Phase Hold =  $C/0 + F + D$   
Phase Next =  $C/0 + F + E$   
Force Off =  $C/0 + F + F$   
(with Ring A Cycle Timer)

Current Calculated Cycle  
Length =  $C/0 + B + F$   
Current Permitted  
Phases =  $E/0 + 7 + 8$

Current Phase  
Bank =  $F/0 + C + E$

Last Power Failure:  
(HR-MIN-DOW) =  $8 + 4$   
(DOW-YR-MONTH) =  $8 + 5$

Last Cabinet Flash  
(HR-MIN-DOW) =  $8 + 6$   
(DOW-YR-MONTH) =  $8 + 7$

Power Fail Counts:  
(Long Failures) =  $F/1 + 0 + C$   
(Short Failures) =  $F/1 + 0 + D$

Current Time:  
(HR-MIN-DOW) =  $8 + 0$   
(DOW-YR-MONTH) =  $8 + 1$   
(MIN-SEC-1/10SEC) =  $8 + F$

**BI Tran Systems, Inc.**  
510 Bercut Dr., Sacramento, Calif. 95814  
916/441-0260  
Traffic Signal Program 233  
"View" Locations  
(Revised 03/94)

**Cover Sheet**

Location: Highway 7 at Drummond Street

Area/District: Ottawa

Timing Based On T.M. Dated: August 01, 2000

Traffic Signal # 241

Timing Developed By: Mona Mekhail

Approved By: Paul Webster

Installed By: Paul Webster

Installation Date: \_\_\_\_\_

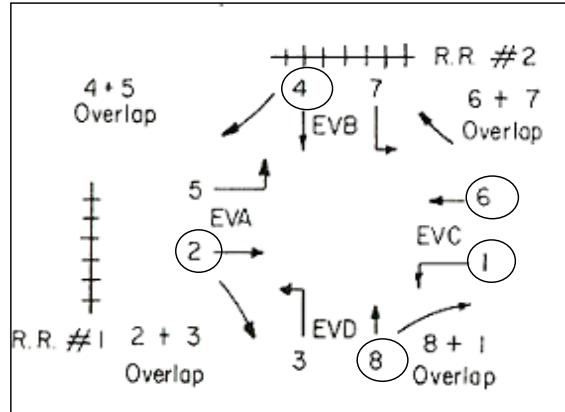
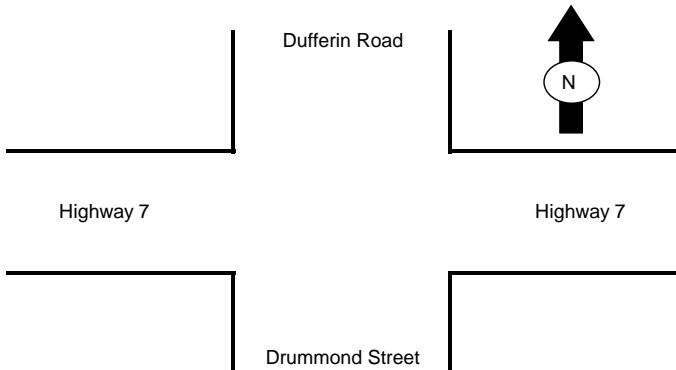

Circle Movements and Operations

**COMMUNICATIONS ADDRESSING**

COMM ADDRESS  
(C/0+0+0) = 1

CELL #: 416-706-1321

ZONE ADDRESS  
(C/0+0+1) = 1

UDP PORT: 8033

AREA NUMBER  
(C/0+0+2) = 4

IP ADDRESS: 10.151.192.13

AREA ADDRESS  
(C/0+0+3) = 241

AMPLIFIER:

PROGRAM: 233ON1.C

**DISABLE ALARM REPORTING**

		Column F							
		1	2	3	4	5	6	7	8
0	OMIT ALARMS					X			
< C + 0 + C = 5 >									

- 1 = STOP TIME
- 2 = FLASH SENSE
- 3 = KEYBOARD ENTRY
- 4 = MANUAL PLAN SELECT
- 5 = ENABLE POLICE CNTRL (Not Used)
- 6 = EXTERNAL ALARM (Door Alarm)
- 7 = DETECTOR FAILURE

# ACTUATED INTERVAL TIMING AND FAZE FUNCTIONS

		PHASE							
		1	2	3	4	5	6	7	8
0	WALK		7		7		7		7
1	DON'T WALK		20		25		20		25
2	MIN INITIAL	7	20		10		20		10
3	TYPE 3 LIMIT								
4	ADD PER VEH								
5	VEH EXT	3.0	4.6		3.0		4.6		3.0
6	MAX GAP	3.0	4.6		3.0		4.6		4.0
7	MIN GAP	3.0	4.6		3.0		4.6		5.0
8	MAX LIMIT	10	40		25		40		55
9	MAXIMUM 2								
A	ADV /DLY WALK								
B	SEQUENCE TO	4							
C	COND SRV MIN								
D	REDUCE EVERY								
E	YELLOW	3.0	5.0		4.1		5.0		4.1
F	RED CLEAR		1.3		2.2		1.3		2.2

**PHASE BANK #1 < C + O + F = 1 >**

		9	A	B	C	D	E
0							RR1 DLY
1	PHASE 1	-					RR1 CLR
2	PHASE 2	25					EVA DLY
3	PHASE 3	-					EVA CLR
4	PHASE 4	-					EVB DLY
5	PHASE 5	-					EVB CLR
6	PHASE 6	25					EVC DLY
7	PHASE 7	-					EVC CLR
8	PHASE 8	-					EVD DLY
							EVD CLR
							RR2 DLY
							RR2 CLR
							EV CLR
							EV DLY
							RR CLR
							RR DLY

ALL RED START  
( F/1 + C + O ) = **5.0**  
RED REVERT  
( F/1 + O + F ) = **5.0**

MAX ALT ALT ALT ALT  
INT WALK FLH INT EXT  
D/W

## COLUMN F PHASES

		1	2	3	4	5	6	7	8
0	PERMIT	X	X		X		X		X
1	RED LOCK								
2	YELLOW LOCK								
3	VEH MIN CALL		X				X		
4	PED RECALL								
5	PEDESTRIANS		X		X		X		X
6	YIELD AT FLSH D/W								
7	RED REST								
8	DOUBLE ENTRY		X		X		X		X
9	VEH MAX CALL								
A	SOFT RECALL								
B	MAXIMUM 2								
C	COND SERVICE								
D	MAN CONT CALL								
E	YELLOW START		X				X		
F	FIRST PHASES				X				X

**< C + O + F = 1 >**

**BI Tran Systems, Inc.**  
510 Bercut Dr., Sacramento, Calif. 95814  
916/441-0260  
Traffic Signal Program **233** Ontario  
Timing Sheet #2

Date: \_\_\_\_\_

**LOCATION**  
Hwy: 7  
At: Drummond Street

	A	B	C
PREEMPT	RR1-2	SP	EMER
MINIMUMS	SPEV1	EV2	VEH
A	WLK (DFLT)	4	4
B	FD WALK		
C	INITAL		

**< C + O + F = 1 >**

## Column E Phases / Bits

		1	2	3	4	5	6	7	8
0	EXCLUSIVE								
1	RR1 CLEAR								
2	RR2 CLEAR								
3	RR2 LTD SRV								
4	PROT/PERM	X							
5	FLH TO PREMT								
6	FLASH ENTRY								
7	DISABL MIN YEL								
8	DISABL OVP YEL								
9	OVP FLH YEL								
A	EM VEH A								
B	EM VEH B								
C	EM VEH C								
D	EM VEH D								
E	EXTRA 1	X	X		X				
F	IC SELECT		X						

**< C + O + E = 125 >**

## Column F Phases / Bits

		1	2	3	4	5	6	7	8
0									
1	EXT PERMIT 1								
2	EXT PERMIT 2								
3	EXCLU PED								
4									
5	PED 2P OUT		X						
6	PED 6P OUT						X		
7	PED 4P OUT				X				
8	PED 8P OUT								X
9	FLH YELLOW								
A									
B									
C									
D									
E	RESTRICTED								
F	EXTRA 2								

**SPECIALS < C + O + F = 2 >**

## Column F Phases / Bits

		1	2	3	4	5	6	7	8
0	ADV GRN FLH								
1	PHASE FLASH								
2	FLASH WALK								
3	GUAR PASS								
4	SIMUL GAP		X		X		X		X
5	SEQ TIMING								
6	ADV WALK								
7	DELAY WALK								
8	EXT RECALL								
9									
A	MAX EXTEN								
B	INH PED RSRV								
C	SEMI ACTUATED								
D									
E	STRT VEH CALL	X	X		X		X		X
F	STRT PED CALL		X		X		X		X

MANUAL PLAN  
**< C/O + A + 1 >**  
MANUAL OFFSET  
**< C/O + B + 1 >**  
**MANUAL SELECTION**

### MANUAL PLAN

- 0 = Automatic (Master)
- 9 = Control Plan 1 - 9
- 14 (E) = Free ( Isolated )
- 15 (F) = Software Flash

### MANUAL OFFSET

- 0 = Automatic (Master)
- 1 = Offset A
- 2 = Offset B
- 3 = Offset C

### FLASH TO PREEMPT

- 1 = EVA
- 2 = EVB
- 3 = EVC
- 4 = EVD
- 5 = RR1
- 6 = RR2
- 7 = SE1
- 8 = SE2
- 1 = TBC TYPE 1
- 2 = NEMA EXT. COORD.
- 3 = DAYLIGHT SAVINGS
- 4 =

### EXTRA 1

- 5 = EXPANDED STATUS REPORTING
- 6 = INTERNATIONAL PED
- 7 = CLEAR OUTPUTS DURING FLASH
- 8 = SPLIT RING

### EXTRA 2

- 1 = AWR ON DURING PHASE INITIAL
- 2 = LMU INSTALLED
- 2 = 2 WAY MODEM
- 3 = 7 WIRE SLAVE
- 4 = FLASH / FREE

### IC SELECT

- 5 = SIMPLEX MASTER
- 7 = 7 WIRE MASTER
- 8 = OFFSET INTURP

# Pretimed

	PHASE							
	1	2	3	4	5	6	7	8
WALK		7		7		7		7
DON'T WALK		20		25		20		25
MIN INTIAL	5	20		10		20		10
TYPE 3 LIMIT								
ADD PER VEH								
VEH EXT	3.0	4.6		3.0		4.6		3.0
MAX GAP	3.0	4.6		3.0		4.6		3.0
MIN GAP	3.0	4.6		3.0		4.6		3.0
MAX LIMIT	5	20		18		20		18
MAXIMUM 2								
ADV / DLY WALK								
SEQUENCE TO	4							
COND SRV MIN								
REDUCE EVERY								
YELLOW	3	5.0		4.1		5.0		4.1
RED CLEAR		1.3		2.2		1.3		2.2

PHASE BANK # < C + O + F = 1 >

Column F  
PHASES

		1	2	3	4	5	6	7	8
0	PERMIT	X	X		X		X		X
1	RED LOCK								
2	YELLOW LOCK								
3	VEH MIN CALL		X				X		
4	PED RECALL								
5	PEDESTRIANS								
6	REST IN WALK								
7	RED REST								
8	DOUBLE ENTRY		X		X		X		X
9	VEH MAX CALL	X	X		X		X		X
A	SOFT RECALL								
B	MAXIMUM 2								
C	CORD SERVICE								
D	MAN CONT CALL								
E	YELLOW START		X				X		
F	FIRST PHASES				X				X

< C + O + F = 1 >

**LOCATION:** Highway 7 at Drummond Street

**Issued Date:**

**Installed Date:**

**BI Tran Systems, Inc.**

510 Bercut Dr., Sacramento, Calif. 95814  
916/441-0260

Traffic Signal Program **233** Ontario

Timing Sheet #2

Revised (02/95)







# Input File Layout

Input File Slot No. →

	1	2	3	4	5	6	7	8	9	10	11	12	13	14
<b>"I" FILE</b>	1 Ext, Cnt, Call <C1-56>	2 Ext, Cnt, Call <C1-39>	2 Ext, Cnt, Call <C1-63>	2 Type 3, Call <C1-47>	3 Ext, Cnt, Call <C1-58>	4 Ext, Cnt, Call <C1-41>	4 Ext, Cnt, Call <C1-65>	4 Type 3, Call <C1-49>	1 Ext, Cnt, Call <C1-60>	NOT WIRED	Door Alarm <C1-80>	2 Ped Call <C1-67>	6 Ped Call <C1-68>	Flash Sense <C1-81>
		2 Ext, Cnt, Call <C1-43>	2 Ext, Cnt, Call <C1-76>			4 Ext, Cnt, Call <C1-45>	4 Ext, Cnt, Call <C1-78>		3 Ext, Cnt, Call <C1-62>		Not Assigned <C1-53>	4 Ped Call <C1-69>	8 Ped Call <C1-70>	Stop Time <C1-82>

**DETECTOR TYPES**

Ext = Extension Detector  
Detector is only active during the Phase's GREEN Intervals (ie, will NOT Call the Phase)

Cnt = Count Detector  
Used in computing "Added Initial"

Call = Calling Detector  
Detector is only active during the Phase's NON-GREEN Intervals (ie, will NOT Extend the Phase)

Type 3 = Type 3 Disconnect  
Will allow a Calling Detector to Extend its Phase until the Call first drops or the "Type 3 Limit" is reached

**"J" FILE**

	5	6	6	6	7	8	8	8	5	NOT WIRED	Not Assigned <C1-54>	EV A Preempt <C1-71>	EV B Preempt <C1-72>	Railroad 1 <C1-51>
	Ext, Cnt, Call <C1-55>	6 Ext, Cnt, Call <C1-40>	6 Ext, Cnt, Call <C1-64>	6 Type 3, Call <C1-48>	7 Ext, Cnt, Call <C1-57>	8 Ext, Cnt, Call <C1-42>	8 Ext, Cnt, Call <C1-66>	8 Type 3, Call <C1-50>	Ext, Cnt, Call <C1-59>		Not Assigned <C1-75>	EV C Preempt <C1-73>	EV D Preempt <C1-74>	Railroad 2 <C1-52>
		6 Ext, Cnt, Call <C1-44>	6 Ext, Cnt, Call <C1-77>			8 Ext, Cnt, Call <C1-46>	8 Ext, Cnt, Call <C1-79>		7 Ext, Cnt, Call <C1-61>					

**BI Tran Systems, Inc.**  
 510 Bercut Dr., Sacramento, Calif. 95814  
 916/441-0260  
 Traffic Signal Program 233  
 Initialized Detector Assignments  
 (Revised 8/92) 332 Cabinet

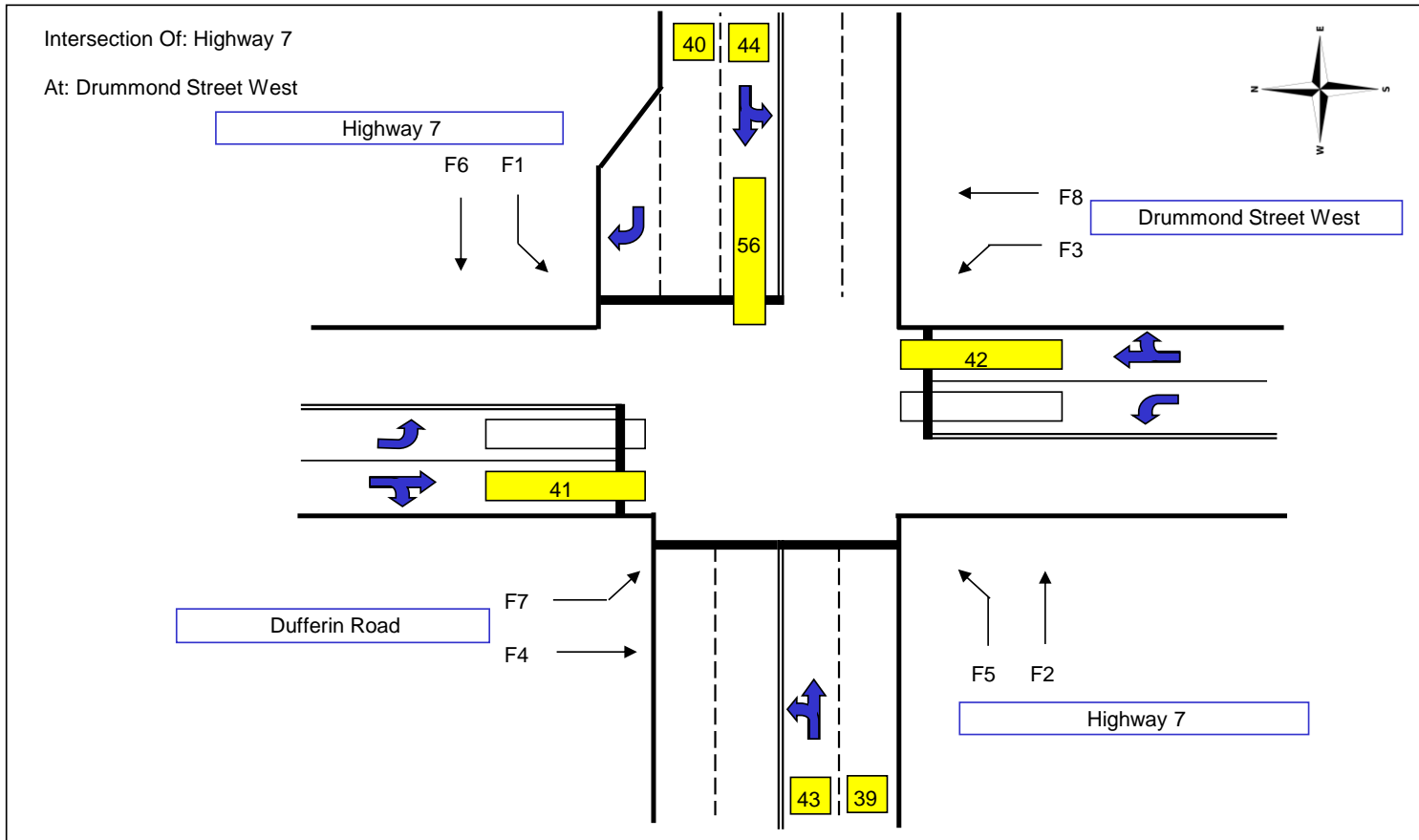

# OVERLAPS AND AAWS

		PED/PHASE/OVERLAP							
		1	2	3	4	5	6	7	8
0	WALK								
1	DON'T WALK								
2	PHASE GREEN								
3	PHASE AMBER								
4	PHASE RED								
5	OVERLAP GREEN								
6	OVERLAP AMBER								
7	OVERLAP RED								

		1								2								3								4							
0	LOAD SW #																																
1	VEH SET 1																																
2	VEH SET 2																																
3	VEH SET 3																																
4	NEG VEH																																
5	NEG PED																																
6	GREEN OMIT																																
7	GRN CLR OMIT																																

**REDIRECT PHASE OUTPUTS** (C + 0 + E = 127)

Enable/Disable  
Phase Redirection

CABINET TYPE :  
(E/125 + D + 0) = 0 ( For 332 cabinet )  
(enable redirection = 30 )

PROGRAMMING OVERLAP SETS		
ASSIGNABLE INPUTS	OVERLAP SET 1	No Programming Required
	OVERLAP SET 2	E/126 + D + C = _____
	OVERLAP SET 3	E/126 + D + D = _____

DATE: 03-Sep-12

LOCATION: \_\_\_\_\_

**BI Tran Systems, Inc.**  
510 Bercut Dr., Sacramento, Calif. 95814  
916/441-0260  
Traffic Signal Program **233** Ontario  
Timing Sheet #2

D	GREEN CLEAR																																
E	AMBER CLEAR																																
F	RED CLEAR																																

**OVERLAP ASSIGNMENTS** (C + 0 + E = 29)

**ADVANCE WARNING FLASHERS**

Time Before Amber	0.0	< F/1+C+E >
Phase Number	0	< F/1+C+F >
Output Pin Number		< E/127+E+8 >

**Advance Warning Beacon - Sign #1**

Time Before Amber	0.0	< F/1+D+E >
Phase Number	0	< F/1+D+F >
Output Pin Number		< E/127+E+9 >

**Advance Warning Beacon - Sign #2**





**COORDINATION**

		PLAN								
Column Numbers ---->		1	2	3	4	5	6	7	8	9
Row	Plan Name ---->									
0	Cycle Length	0	0	0	0	0	0	0	0	0
1	Phase 1 - ForceOff	0	0	0	0	0	0	0	0	0
2	Phase 2 - ForceOff	0	0	0	0	0	0	0	0	0
3	Phase 3 - ForceOff	0	0	0	0	0	0	0	0	0
4	Phase 4 - ForceOff	0	0	0	0	0	0	0	0	0
5	Phase 5 - ForceOff	0	0	0	0	0	0	0	0	0
6	Phase 6 - ForceOff	0	0	0	0	0	0	0	0	0
7	Phase 7 - ForceOff	0	0	0	0	0	0	0	0	0
8	Phase 8 - ForceOff	0	0	0	0	0	0	0	0	0
9	Ring Offset	0	0	0	0	0	0	0	0	0
A	Offset 1	0	0	0	0	0	0	0	0	0
B	Offset 2	0	0	0	0	0	0	0	0	0
C	Offset 3	0	0	0	0	0	0	0	0	0
D	Perm 1 - End	0	0	0	0	0	0	0	0	0
E	Hold Release	255	255	255	255	255	255	255	255	255
F	Zone Offset	0	0	0	0	0	0	0	0	0

Coordination - Bank 1 <C+0+C=1>

Row										
0	Ped Adjustment	0	0	0	0	0	0	0	0	0
1	Perm 2 - Start	0	0	0	0	0	0	0	0	0
2	Perm 2 - End	0	0	0	0	0	0	0	0	0
3	Perm 3 - Start	0	0	0	0	0	0	0	0	0
4	Perm 3 - End	0	0	0	0	0	0	0	0	0
5	Reservice Time	0	0	0	0	0	0	0	0	0
6	Reservice Phases									
7										
8	Pretimed Phases									
9	Max Recall									
A	Perm 1 Veh Phase	1_345_7	1_345_7	1_345_7	1_345_7	1_345_7	1_345_7	1_345_7	1_345_7	1_345_7
B	Perm 1 Ped Phase	1_345_7	1_345_7	1_345_7	1_345_7	1_345_7	1_345_7	1_345_7	1_345_7	1_345_7
C	Perm 2 Veh Phase									
D	Perm 2 Ped Phase									
E	Perm 3 Veh Phase									
F	Perm 3 Ped Phase									

Coordination - Bank 2 <C+0+C=2>

Row		2
1	Phase 1	10
2	Phase 2	10
3	Phase 3	10
4	Phase 4	10
5	Phase 5	10
6	Phase 6	10
7	Phase 7	10
8	Phase 8	10

Coordination Transition  
Minimums < C+0+C = 5 >

Transition Type  < C/5+1+9 >  
**TBC TRANSITION**

Lag Hold Phases  < C/5+1+A >  
**Coordinated Lag Hold Phases**

Sync Output Time  < C/5+1+C >  
**7 - Wire Master**

Transition Type  
0.X = Shortway  
1.X = Lengthen  
X.1 thru X.4 = # of cycles  
when lengthening

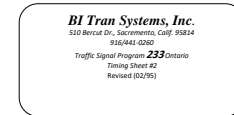

DATE:

03-Sep-12

LOCATION:

(Coord Extra Bit 1 = Programmed WALK Time for Sync Phases)

Row	E	Row	Time	Plan	Offset	Day of Week
0		0	0:00	0	0	
1	Plan 1 - Sync	2_6_	0:00	0	0	
2	Plan 2 - Sync	2_6_	0:00	0	0	
3	Plan 3 - Sync	2_6_	0:00	0	0	
4	Plan 4 - Sync	2_6_	0:00	0	0	
5	Plan 5 - Sync	2_6_	0:00	0	0	
6	Plan 6 - Sync	2_6_	0:00	0	0	
7	Plan 7 - Sync	2_6_	0:00	0	0	
8	Plan 8 - Sync	2_6_	0:00	0	0	
9	Plan 9 - Sync	2_6_	0:00	0	0	
A	NEMA Sync		0:00	0	0	
B	NEMA Hold		0:00	0	0	
C			0:00	0	0	
D			0:00	0	0	
E	Coord Extra	#NAME?	0:00	0	0	
F			0:00	0	0	

Sync Phases < C+0+C = 1 >

TOD Coordination < C+0+9 = 0.1 >  
( Bank 1 )

Row	F	Row	Time	Plan	Offset	Day of Week
0	Free Lag	2_4_6_8	0:00	0	0	
1	Plan 1 - Lag	2_4_6_8	0:00	0	0	
2	Plan 2 - Lag	2_4_6_8	0:00	0	0	
3	Plan 3 - Lag	2_4_6_8	0:00	0	0	
4	Plan 4 - Lag	2_4_6_8	0:00	0	0	
5	Plan 5 - Lag	2_4_6_8	0:00	0	0	
6	Plan 6 - Lag	2_4_6_8	0:00	0	0	
7	Plan 7 - Lag	2_4_6_8	0:00	0	0	
8	Plan 8 - Lag	2_4_6_8	0:00	0	0	
9	Plan 9 - Lag	2_4_6_8	0:00	0	0	
A	External Lag		0:00	0	0	
B			0:00	0	0	
C			0:00	0	0	
D			0:00	0	0	
E			0:00	0	0	
F			0:00	0	0	

Lag Phases < C+0+C=1 >

TOD Coordination < C+0+9 = 0.2 >  
( Bank 2 )

Assignable Inputs&Outputs

Column A		Column B		Column C		Column D		Column E		Column F			
0	NOT 3	0	MAX 2	0	PRETIME	0	WEEKDAY	0	DIAL 2	0	0	0	
1	NOT 4	0	SYSDET 1	0	PLAN 1	0	X PERM 1	0	DIAL 3	0	EVA	71	1
2	OR 4	0	SYSDET 2	0	PLAN 2	0	X PERM 2	0	OFFSET 1	0	EVB	72	2
3	OR 4	0	SYSDET 3	0	PLAN 3	0	DIM	0	OFFSET 2	0	EVC	73	3
4	OR 5	0	SYSDET 4	0	PLAN 4	0	X CLOCK	0	OFFSET 3	0	EVD	74	4
5	OR 5	0	SYSDET 5	0	PLAN 5	0	STOP TIME	82	FREE	0	RR 1	51	5
6	OR 6	0	SYSDET 6	0	PLAN 6	0	FL SENSE	81	FLASH	0	RR 2	52	6
7	OR 6	0	SYSDET 7	0	PLAN 7	0	ENABLE	0	XPED OMIT	0	SP EVNT 1	0	7
8		0	SYSDET 8	0	PLAN 8	0	ADVANCE	0	NOT 1	0	SP EVNT 2	0	8
9		0	MAX INBT	0	PLAN 9	0	ALARM	80	NOT 2	0	EXT LAG	0	9
A	AND 4	0	FORCE A	0	DELAY A	0	PH BNK 2	0	OR 1	0	AND 1	0	A
B	AND 4	0	FORCE B	0	DELAY B	0	PH BNK 3	0	OR 1	0	AND 1	0	B
C	NAND 1	0	C NA	0	DELAY C	0	OLAP SET 2	0	OR 2	0	AND 2	0	C
D	NAND 1	0	HOLD	0	DELAY D	0	OLAP SET 3	0	OR 2	0	AND 2	0	D
E	NAND 2	0	VE CALL	0	DELAY E	0	DET SET 2	0	OR 3	0	AND 3	0	E
F	NAND 2	0	RECALL	0	DELAY F	0	DET SET 3	0	OR 3	0	AND 3	0	F

ASSIGNABLE INPUTS < C + O + E = 126>

Column A		Column B		Column C		Column D		Column E		Column F			
0		0	FLASHER 0	0	FREE	0	NOT 1	0	TOD 1	0	DIAL 2	0	0
1	SP EV 1	0	FLASHER 1	0	PLAN 1	0	OR 1	0	TOD 2	0	DIAL 3	0	1
2	SP EV 2	0	FAST FLSHR	0	PLAN 2	0	OR 2	0	TOD 3	0	OFFSET 1	0	2
3	SP EV 3	0		0	PLAN 3	0	OR 3	0	TOD 4	0	OFFSET 2	0	3
4	SP EV 4	0		0	PLAN 4	0	AND 1	0	TOD 5	0	OFFSET 3	0	4
5	SP EV 5	0		0	PLAN 5	0	AND 2	0	TOD 6	0	FREE	0	5
6	SP EV 6	0		0	PLAN 6	0	AND 3	0	TOD 7	0	FLASH	0	6
7	SP EV 7	0		0	PLAN 7	0	NOT 2	0	TOD 8	0	PREEMPT	0	7
8	SP EV 8	0	NOT 3	0	PLAN 8	0	EVA	0	WARN 1	0		231	8
9		0	NOT 4	0	PLAN 9	0	EVB	0	WARN 2	0		232	9
A	DET FAIL	0	OR 4	0		0	EVC	0	DEALY A	0		233	A
B		0	OR 5	0		0	EVD	0	DELAY B	0		234	B
C		0	OR 6	0		0	RR1	0	DELAY C	0		235	C
D	CENT. CTRL	0	AND 4	0		0	RR2	0	DELAY D	0		236	D
E	EXCL FDW	0	NAND 1	0		0	SP EVNT 1	0	DELAY E	0		233	E
F	EXCL WALK	0	NAND 2	0		0	SP EVNT 2	0	DELAY F	0		238	F

ASSIGNABLE OUTPUTS < C + O + E = 127>

# DEFAULT DETECTOR ASSIGNMENTS

Standard 332 Cabinet Location	Column 0	Column 1 ATTRIBUTES								Column 2 PHASE(S)								Column 3 ASSIGNMENTS							
	C1 PIN NUMBER	1	2	3	4	5	6	7	8	1	2	3	4	5	6	7	8	1	2	3	4	5	6	7	8
		I-2 U --->	0	39			X	X	X		X								X	X	X				
J-2 U --->	1	40			X	X	X						X				X	X	X					X	
I-6 U --->	2	41			X	X	X					X					X	X	X					X	
J-6 U --->	3	42			X	X	X						X				X	X	X					X	
I-2 L --->	4	43			X	X	X		X								X	X	X					X	
J-2 L --->	5	44			X	X	X					X					X	X	X					X	
I-6 L --->	6	45			X	X	X					X					X	X	X					X	
J-6 L --->	7	46			X	X	X						X				X	X	X					X	
I-4 --->	8	47				X	X		X								X	X	X					X	
J-4 --->	9	48				X	X					X					X	X	X					X	
I-8 --->	A	49				X	X					X					X	X	X					X	
J-8 --->	B	50				X	X						X				X	X	X					X	
J-1 --->	C	55			X	X	X					X					X	X	X					X	
I-1 --->	D	56			X	X	X	X									X	X	X					X	
J-5 --->	E	57			X	X	X					X					X	X	X					X	
I-5 --->	F	58			X	X	X		X								X	X	X					X	

"INITIALIZED" DETECTOR ASSIGNMENTS  
< C + 0 + E = 126 >

Standard 332 Cabinet Location	Column 4	Column 5 ATTRIBUTES								Column 6 PHASE(S)								Column 7 ASSIGNMENTS							
	C1 PIN NUMBER	1	2	3	4	5	6	7	8	1	2	3	4	5	6	7	8	1	2	3	4	5	6	7	8
		J-9 U --->	0	59			X	X	X									X							
I-9 U --->	1	60			X	X	X	X								X								X	
J-9 L --->	2	61			X	X	X								X									X	
I-9 L --->	3	62			X	X	X					X												X	
I-3 U --->	4	63			X	X	X		X															X	
J-3 U --->	5	64			X	X	X								X									X	
I-7 U --->	6	65			X	X	X					X												X	
J-7 U --->	7	66			X	X	X										X	X	X					X	
I-12 U --->	8	67	X									X												X	
I-13 U --->	9	68	X										X											X	
I-12 L --->	A	69	X										X											X	
I-13 L --->	B	70	X														X	X	X					X	
I-3 L --->	C	76			X	X	X		X															X	
J-3 L --->	D	77			X	X	X								X									X	
I-7 L --->	E	78			X	X	X					X												X	
J-7 L --->	F	79			X	X	X										X							X	

"INITIALIZED" DETECTOR ASSIGNMENTS  
< C + 0 + E = 126 >

**DETECTOR ATTRIBUTES**

- 1= Full time Delay
- 2= Pedestrian call
- 3=
- 4= Count
- 5= Extension
- 6= Type 3
- 7= Calling
- 8= Alternate

**DETECTOR ASSIGNMENTS**

- 1 = Det. Set #1
- 2 = Det. Set #2
- 3 = Det. Set #3
- 4 =
- 5 =
- 6 = MIN Recall On Failure
- 7 = MAX Recall On Failure
- 8 = Report On Failure

**DETECTOR TYPES**

- Ext = Extension Detector  
Detector is only active during the Phase's GREEN Intervals (ie, will NOT Call the Phase)
- Cnt = Count Detector  
Used in computing "Added Initial"
- Call = Calling Detector  
Detector is only active during the Phase's NON-GREEN Intervals (ie, will NOT Extend the Phase)
- Type 3 = Type 3 Disconnect  
Will allow a Calling Detector to Extend its Phase until the Call first drops or the "Type 3 Limit" is reached

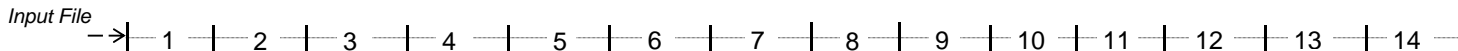

**"I" FILE**

1 Ext, Cnt, Call <C1-56>	2 Ext, Cnt, Call <C1-39>	2 Ext, Cnt, Call <C1-63>	2 Type 3, Call <C1-47>	3 Ext, Cnt, Call <C1-58>	4 Ext, Cnt, Call <C1-41>	4 Ext, Cnt, Call <C1-65>	4 Type 3, Call <C1-49>	NOT WIRED	Not Assigned <C1-80>	2 Ped Call <C1-67>	6 Ped Call <C1-68>	Flash Sense <C1-81>
	2 Ext, Cnt, Call <C1-43>	2 Ext, Cnt, Call <C1-76>			4 Ext, Cnt, Call <C1-45>	4 Ext, Cnt, Call <C1-78>			3 Ext, Cnt, Call <C1-53>	4 Ped Call <C1-69>	8 Ped Call <C1-82>	

**"J" FILE**

5 Ext, Cnt, Call <C1-55>	6 Ext, Cnt, Call <C1-40>	6 Ext, Cnt, Call <C1-64>	6 Type 3, Call <C1-48>	7 Ext, Cnt, Call <C1-57>	8 Ext, Cnt, Call <C1-42>	8 Ext, Cnt, Call <C1-66>	8 Type 3, Call <C1-50>	NOT WIRED	Not Assigned <C1-54>	EV A Preempt <C1-71>	EV B Preempt <C1-72>	Railroad 1 <C1-51>
	6 Ext, Cnt, Call <C1-44>	6 Ext, Cnt, Call <C1-77>			8 Ext, Cnt, Call <C1-46>	8 Ext, Cnt, Call <C1-79>			7 Ext, Cnt, Call <C1-61>	EV C Ped Call <C1-73>	EV D Preempt <C1-74>	Railroad 2 <C1-52>

**BI Tran Systems, Inc.**  
 510 Bercut Dr., Sacramento, Calif. 95814  
 916/441-0260  
 Traffic Signal Program 233  
 Initialized Detector Assignments  
 (Revised 8/92) 332 Cabinet

# REFERENCE SHEET

## Controller Intervals

0 = Walk	8 = Red Rest
1 = FDW	9 = Preemption
2 = Min. Green	A = Stop Time
3 =	B = Red Revert
4 = Var. Initial	C = Yellow-Gap Termination
5 = Extension	D = Yellow-Max. Termination
6 =	E = Yellow-Forceoff Termination
7 = Reduce Gap	F = Red Clearance

## Continuous Memory Error Monitoring

The controller's RAM and EPROM memories are continuously checked for errors. If an error is found, the intersection will go into FLASH (via Watch Dog Timer), and one of the following will be shown on the controller's display:

- bAd A = An error was detected in the CPU's RAM, or a new program has been installed on the memory module.  
Often caused by a bad controller "gel-cell" battery.
- bAd b = An error was detected in the memory module's RAM.  
Often caused by a bad "lithium" battery on the memory module.
- bAd E = An error was detected in the 233 Program EPROM.
- bAd F = An error was detected in the Z-RAM (Dallas chip) on the memory module.

## 412/C Memory Module

### Lithium Battery Condition

To check the condition of the 3.6 volt Lithium Battery on the 412/C Memory Module:

- If  $E/112 + 0 + A = 84$  - the battery is BAD
- If  $E/112 + 0 + A = 85$  - the battery is O.K.

### Monitor "Activate" Flags

(Also Requires T.O.D. Function "E" Flag)  
Detector Count Recording:  
 $E/2 + 0 + 9 =$  Not Zero  
Real Time Split Monitor:  
 $E/2 + 0 + E =$  Not Zero

**E Page Enable:  $F/1 + 9 + E =$  Not Zero**

## Display Movement Codes

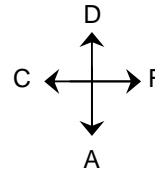

A = Advance ROW  
D = Decrement ROW  
C = COLUMN Back  
F = Forward COLUMN

## Special Event Schedules

Special Event #1:  $C + 0 + E = 27$   
Special Event #2:  $C + 0 + E = 28$

Current Interval =  $E + 5 + 0$   
Current Interval Timer =  $E + 5 + B$   
Current Interval Clearance Phases =  $E + 5 + C$

## Time of Day Function (7 Key)

Current T.O.D. "E Function"  
Control Bits =  $C/0 + E + E$   
Current T.O.D. "F Function"  
Output Bits =  $C/0 + E + F$

## Logic DELAY Gate

### Delay Timer Display

DELAY A Timer =  $C/0 + 9 + A$   
DELAY B Timer =  $C/0 + 9 + B$   
thru thru  
DELAY F Timer =  $C/0 + 9 + F$

## Interval Timer Display

Ring A =  $F/0 + A +$  Interval Row  
Ring B =  $F/0 + B +$  (Interval Row From PHASE BANK data)

## Display Locations

Plan Select      Offset Select

Manual =  $C/0 + A + 1$        $C/0 + B + 1$   
Master =  $C/0 + A + 2$        $C/0 + B + 2$   
Current =  $C/0 + A + 3$        $C/0 + B + 3$   
Next =  $C/0 + A + 4$        $C/0 + B + 4$   
TOD =  $C/0 + A + 5$        $C/0 + B + 5$   
Master Cycle =  $C/0 + A + 0$   
Ring A Cycle =  $C/0 + B + 0$   
Ring B Cycle =  $C/0 + D + 0$

MIN Cycle =  $C/0 + A + E$   
MAX Cycle =  $C/0 + B + E$

Phase Hold =  $C/0 + F + D$   
Phase Next =  $C/0 + F + E$   
Force Off =  $C/0 + F + F$   
(with Ring A Cycle Timer)

Current Calculated Cycle  
Length =  $C/0 + B + F$   
Current Permitted  
Phases =  $E/0 + 7 + 8$

Current Phase  
Bank =  $F/0 + C + E$

Last Power Failure:  
(HR-MIN-DOW) =  $8 + 4$   
(DOW-YR-MONTH) =  $8 + 5$

Last Cabinet Flash  
(HR-MIN-DOW) =  $8 + 6$   
(DOW-YR-MONTH) =  $8 + 7$

Power Fail Counts:  
(Long Failures) =  $F/1 + 0 + C$   
(Short Failures) =  $F/1 + 0 + D$

Current Time:  
(HR-MIN-DOW) =  $8 + 0$   
(DOW-YR-MONTH) =  $8 + 1$   
(MIN-SEC-1/10SEC) =  $8 + F$

**BI Tran Systems, Inc.**  
510 Bercut Dr., Sacramento, Calif. 95814  
916/441-0260  
Traffic Signal Program 233  
"View" Locations  
(Revised 03/94)

# 15 MIN REPORT

Intersection ID:140701007

HWY 7 @ DRUMMOND ST W(S) - DUFFERIN ST(N)

Municipality: Eastern

Date: 31-Jul-2019

Time	NORTH APPROACH								EAST APPROACH								SOUTH APPROACH								WEST APPROACH								Total									
	Cars			Trucks			Heavies		Ped	Cars			Trucks			Heavies		Ped	Cars			Trucks			Heavies		Ped															
	Left	Thru	Right	Left	Thru	Right	Left	Thru	Right		Left	Thru	Right	Left	Thru	Right	Left	Thru	Right		Left	Thru	Right	Left	Thru	Right	Left	Thru	Right													
Period1																																										
7:15	1	4	3	0	1	1	0	0	0	0	9	30	1	0	2	0	0	6	0	0	29	5	23	0	0	0	0	0	0	0	3	35	25	0	0	0	0	0	3	0	0	181
7:30	0	1	10	0	0	2	0	0	0	0	12	40	0	0	0	0	0	2	0	0	25	5	14	1	0	0	0	0	0	0	4	55	24	0	3	0	0	8	0	0	206	
7:45	1	2	4	0	0	0	0	0	0	0	24	43	2	1	3	0	0	3	0	1	37	8	17	0	1	0	0	0	0	0	6	53	24	0	1	0	0	4	0	0	235	
8:00	1	3	7	0	1	0	0	0	1	0	16	55	2	0	4	0	0	4	0	0	37	11	25	3	1	0	0	0	0	0	6	46	32	0	1	1	0	5	1	0	263	
8:15	2	7	14	0	0	1	0	0	0	0	20	45	4	0	2	0	0	2	0	0	29	13	15	0	0	0	0	0	0	0	8	40	42	1	2	1	0	2	0	0	250	
8:30	2	4	8	0	1	1	0	0	0	0	29	50	6	1	1	0	0	1	0	0	31	10	24	3	0	0	0	0	0	0	9	36	35	0	1	1	0	3	0	0	257	
8:45	6	9	13	1	0	0	0	0	0	0	19	46	4	1	1	0	1	5	0	0	33	11	19	0	0	0	0	0	0	0	14	48	35	1	1	1	0	6	0	0	275	
9:00	0	12	14	2	0	0	0	0	0	0	25	77	1	1	6	1	0	6	1	0	40	9	18	1	0	0	0	0	0	0	13	56	20	2	2	0	0	1	0	0	308	
Period2																																										
11:15	4	3	18	0	0	1	0	0	1	0	28	72	2	0	4	0	0	6	0	0	46	11	20	0	0	0	0	0	0	0	16	58	28	0	3	1	0	5	0	0	327	
11:30	3	11	16	0	0	0	0	0	0	0	23	70	3	0	4	0	0	5	0	0	54	12	13	0	0	1	0	0	0	0	21	62	36	0	0	0	0	2	0	0	336	
11:45	5	8	30	0	0	0	0	0	0	0	19	90	5	0	2	1	0	8	0	0	47	9	24	1	0	1	0	0	0	0	11	43	39	0	1	3	0	6	0	0	353	
12:00	3	11	11	1	1	0	0	0	0	0	23	88	3	1	3	1	0	11	0	0	39	13	23	2	0	0	0	0	0	0	13	86	40	1	1	0	0	2	0	0	377	
12:15	2	13	21	0	1	0	0	0	0	0	31	97	5	1	1	0	0	6	0	0	54	12	29	1	1	1	0	0	0	1	19	71	44	0	2	1	1	4	0	0	419	
12:30	2	10	13	0	0	0	0	0	1	0	17	88	1	1	1	0	0	6	0	1	57	11	18	0	0	0	0	0	0	0	21	65	39	0	3	0	1	2	0	0	358	
12:45	1	8	20	1	0	0	1	0	0	0	21	77	3	0	1	0	0	6	0	1	46	7	22	2	0	1	0	0	0	0	12	65	40	0	4	0	0	1	0	0	340	
13:00	3	9	19	0	0	1	0	0	0	0	22	67	4	0	2	1	0	5	0	0	39	9	21	0	0	0	0	0	0	2	16	67	37	1	0	2	0	4	0	2	333	
13:15	3	6	16	0	0	2	0	0	0	0	20	76	3	0	5	0	0	4	0	0	52	11	26	0	1	1	0	0	0	0	16	75	38	0	3	0	0	4	0	0	362	
13:30	2	6	18	0	0	1	0	0	0	0	21	68	3	1	6	0	0	8	0	0	50	11	15	2	0	0	0	0	0	0	16	83	33	1	4	1	0	6	0	0	356	
13:45	4	12	8	0	0	1	0	0	0	0	30	75	6	0	6	0	0	3	0	0	43	9	19	0	0	0	0	0	0	0	9	67	32	1	4	1	0	5	0	0	335	
14:00	2	9	21	0	0	0	0	0	0	0	24	72	3	1	2	1	0	5	1	0	51	19	21	0	1	0	0	0	0	0	9	53	32	0	3	1	0	1	0	0	332	
Period3																																										
15:15	3	10	22	0	0	0	0	0	0	0	24	65	2	1	2	0	0	7	0	0	54	14	31	1	0	1	0	0	0	0	12	87	29	1	2	0	0	5	0	0	373	
15:30	2	11	13	0	0	0	0	0	0	0	29	78	5	0	2	0	0	2	0	1	43	11	25	0	0	0	0	0	0	0	7	98	35	0	4	0	0	7	0	0	373	
15:45	2	7	16	0	0	0	1	0	0	0	21	69	2	0	1	0	0	7	0	1	58	6	28	0	1	2	0	0	0	0	18	91	30	0	5	0	0	3	0	0	369	
16:00	5	6	21	0	0	0	0	0	0	0	26	96	2	1	3	0	0	6	1	0	54	15	42	0	0	0	0	0	0	0	12	73	28	1	2	0	0	2	0	0	396	
16:15	0	6	19	0	0	1	0	0	0	0	22	59	2	0	3	0	0	5	0	0	51	8	29	0	0	0	0	0	0	0	11	80	29	0	0	0	0	3	0	2	330	
16:30	1	8	14	0	0	0	0	0	0	0	28	84	1	0	4	0	0	5	0	0	70	7	33	0	0	1	0	0	0	0	13	84	33	0	4	0	0	3	0	0	393	
16:45	5	7	18	0	0	0	0	0	1	0	24	82	5	0	1	0	0	7	0	0	30	2	15	0	0	0	0	0	0	0	15	89	31	0	2	0	0	3	1	0	338	
17:00	2	5	11	0	0	0	0	0	0	0	30	81	1	0	0	0	0	5	0	0	34	5	14	0	0	0	0	0	0	0	17	94	86	0	1	0	0	5	0	0	391	
17:15	5	3	19	0	0	0	0	0	0	0	19	102	1	0	3	0	0	3	0	0	52	4	31	0	0	0	0	0	0	0	15	111	90	0	4	0	0	5	0	0	467	
17:30	2	6	15	0	0	0	0	0	0	0	29	96	1	0	2	0	0	2	0	0	55	1	23	1	0	1	0	0	1	0	12	81	57	0	0	1	1	6	0	0	393	
17:45	2	5	7	0	0	0	0	0	1	0	27	80	1	0	0	0	0	5	0	0	56	6	23	0	0	0	0	0	0	0	8	99	33	0	2	0	0	5	0	0	360	
18:00	2	1	11	0	0	0	0	0	0	0	17	82	1	0	1	0	0	6	0	0	37	4	19	0	0	0	0	0	0	0	8	83	30	0	5	0	0	10	0	0	317	

# 15 MIN REPORT

Intersection ID:14080000

HWY 7 @ LANARK RD 43/WILSON ST(S)-CANADIAN TIRE

Municipality: Eastern

Date: 31-Jul-2019

Time	NORTH APPROACH								EAST APPROACH								SOUTH APPROACH								WEST APPROACH								Total								
	Cars			Trucks			Heavies			Ped	Cars			Trucks			Heavies			Ped	Cars			Trucks			Heavies			Ped											
	Left	Thru	Right	Left	Thru	Right	Left	Thru	Right		Left	Thru	Right	Left	Thru	Right	Left	Thru	Right		Left	Thru	Right	Left	Thru	Right	Left	Thru	Right												
Period1																																									
7:15	3	4	4	0	0	0	0	0	0	0	13	38	2	2	5	0	0	6	0	0	27	5	21	2	1	0	2	0	1	0	4	37	25	0	0	3	0	3	0	0	208
7:30	3	2	7	0	0	0	0	0	0	0	15	51	0	1	3	0	1	1	0	3	26	4	22	1	0	2	0	0	1	0	4	65	33	0	2	3	0	5	0	0	255
7:45	6	6	7	0	0	0	0	0	0	0	23	53	0	1	2	0	0	3	0	1	37	4	23	0	0	0	0	0	1	0	6	69	59	0	2	2	0	4	0	0	309
8:00	2	5	9	0	0	0	0	0	0	0	24	64	1	2	3	0	1	4	0	0	36	6	23	1	0	1	3	0	0	0	14	76	41	0	2	2	0	4	2	0	326
8:15	5	7	6	0	0	0	0	1	0	1	31	67	0	1	3	0	0	2	0	1	42	9	24	4	0	3	1	0	1	0	7	79	42	0	1	4	0	2	3	1	348
8:30	4	8	8	0	0	0	0	0	0	2	38	55	0	1	2	0	0	1	0	1	41	6	28	3	0	2	3	0	0	0	6	67	53	0	1	0	0	2	1	2	335
8:45	2	8	7	0	0	0	0	0	0	0	23	70	0	1	2	0	1	4	0	2	36	4	28	2	0	0	2	0	3	0	7	82	42	1	2	2	0	3	0	0	334
9:00	6	9	11	0	0	1	0	0	0	0	30	80	1	2	2	0	3	4	0	2	36	6	30	3	0	2	0	0	1	0	10	61	48	0	3	0	0	1	1	0	353
Period2																																									
11:15	11	17	15	0	0	0	0	0	0	0	46	104	1	3	2	0	2	6	0	0	45	12	33	3	0	1	0	0	3	0	13	69	62	0	3	1	0	2	1	0	455
11:30	9	18	19	0	0	0	0	0	0	1	39	93	1	0	1	0	5	1	0	2	47	14	50	2	0	0	0	0	0	0	7	81	47	0	2	3	0	1	3	1	447
11:45	11	17	9	0	0	0	0	0	0	0	45	104	2	2	2	0	3	4	0	3	59	13	31	2	0	0	2	0	3	0	20	71	47	0	4	1	0	1	3	2	461
12:00	4	14	18	2	0	1	0	0	0	0	44	108	0	2	2	0	1	9	0	1	55	10	46	0	0	0	1	0	0	0	17	105	52	0	0	1	0	2	2	0	497
12:15	14	10	22	0	0	1	0	0	0	0	43	115	4	1	1	0	0	6	0	1	70	13	40	0	0	0	0	0	4	0	11	92	52	1	2	2	0	2	0	0	507
12:30	4	13	25	0	0	0	0	0	0	0	38	115	3	0	0	0	3	3	0	3	64	15	39	8	0	2	1	0	3	0	12	102	50	0	0	0	0	1	1	0	505
12:45	13	17	17	0	0	0	1	0	0	0	39	108	3	0	4	0	2	5	0	0	65	17	39	0	0	1	1	0	3	0	13	71	53	0	2	2	1	1	1	0	479
13:00	9	19	13	0	0	0	1	1	0	0	41	86	0	1	2	0	1	4	0	3	56	15	38	0	0	0	2	0	1	1	13	80	63	0	1	2	0	1	2	4	460
13:15	12	19	18	0	0	0	0	0	0	0	35	99	0	3	5	0	0	2	1	2	69	15	46	1	0	1	2	0	3	0	7	92	62	0	2	0	0	1	4	0	501
13:30	7	10	22	0	0	0	0	0	0	0	32	83	1	2	6	0	2	6	0	1	62	21	36	1	0	4	2	0	2	0	7	109	49	0	2	2	0	4	1	0	474
13:45	7	25	19	0	0	1	0	0	0	0	33	88	0	1	6	0	2	1	0	0	56	14	39	1	0	1	3	0	2	0	6	80	53	0	4	1	0	3	0	0	446
14:00	7	11	14	0	0	0	0	0	0	0	35	97	2	0	1	0	1	3	0	0	60	17	32	5	0	2	4	0	0	2	16	71	49	0	1	0	0	2	0	3	435
Period3																																									
15:15	16	19	15	0	0	0	0	0	0	0	41	103	2	1	2	0	1	5	0	5	71	17	41	1	0	2	2	0	1	2	20	96	58	0	2	2	0	5	1	0	531
15:30	6	16	25	0	0	0	0	0	0	0	41	92	2	3	0	0	1	2	0	0	50	11	41	2	0	6	1	0	1	0	14	114	67	0	0	5	0	5	0	0	505
15:45	7	13	22	0	0	0	0	0	0	0	25	110	1	1	3	1	1	4	0	1	65	14	46	0	0	1	2	0	1	0	8	105	45	0	2	1	0	2	1	0	482
16:00	5	19	20	0	0	0	0	0	0	0	40	123	1	3	0	0	3	3	0	1	56	11	40	2	0	2	2	0	2	0	8	77	49	0	1	4	0	0	1	0	473
16:15	13	10	16	0	1	0	0	0	0	0	35	108	4	2	2	0	1	5	0	2	30	9	19	0	0	0	0	0	0	0	11	101	50	0	0	0	0	3	0	0	422
16:30	5	11	21	0	0	0	0	0	0	0	31	131	1	1	3	0	1	4	0	0	29	6	27	1	0	0	1	0	1	0	8	106	37	0	4	0	0	2	2	0	433
16:45	11	9	19	0	0	0	0	0	0	0	45	93	0	0	3	0	1	5	0	0	51	8	52	1	0	1	0	0	1	0	15	87	49	0	1	1	0	3	1	0	457
17:00	19	0	19	0	0	0	0	0	0	0	11	105	3	0	0	0	0	4	0	1	35	7	37	0	0	1	0	0	0	0	8	154	4	0	1	0	0	5	0	0	414
17:15	12	0	19	0	0	0	0	0	0	0	1	168	3	0	2	0	0	4	0	2	32	1	26	0	0	0	0	0	0	0	11	193	0	0	5	0	0	4	0	0	483
17:30	9	3	13	0	0	0	0	0	0	0	30	130	2	0	3	0	0	2	0	2	11	0	13	1	0	0	0	0	0	0	9	135	31	0	1	0	0	7	1	0	403
17:45	4	8	11	0	0	0	0	0	0	1	35	110	1	0	0	0	0	6	0	2	15	1	10	0	0	0	0	0	0	0	11	127	37	1	2	1	0	5	2	0	390
18:00	13	7	13	1	0	0	0	0	0	0	38	82	0	0	0	0	0	6	0	2	9	1	14	0	0	0	0	0	0	0	10	115	32	0	4	0	0	9	0	0	356



## APPENDIX D – TRAFFIC VOLUME FIGURES

Background Traffic  
 Buildout Year 2030  
 AM xxx  
 PM (xxx)

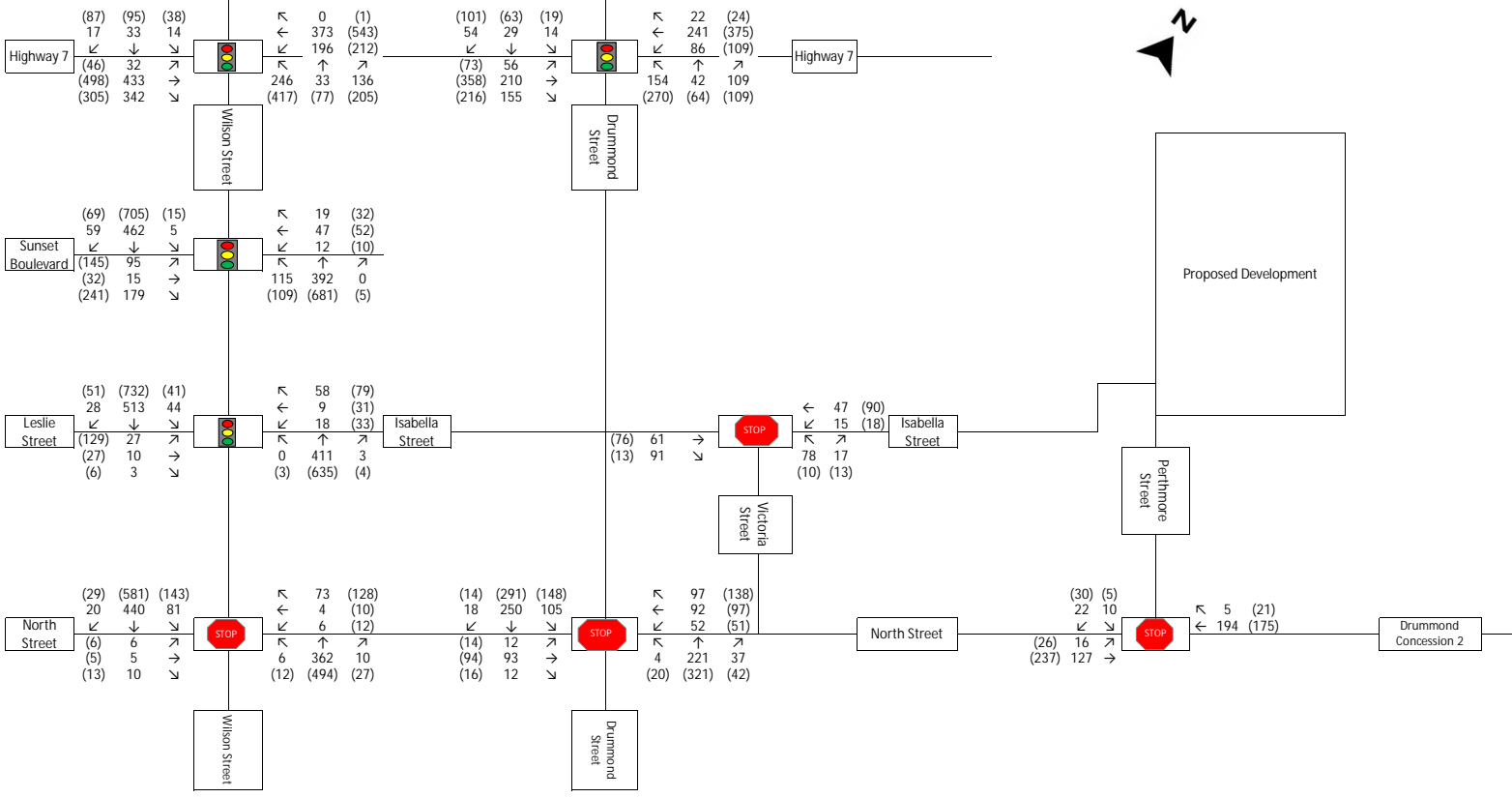

Background Traffic  
 Horizon Year 2035  
 AM xxx  
 PM (xxx)

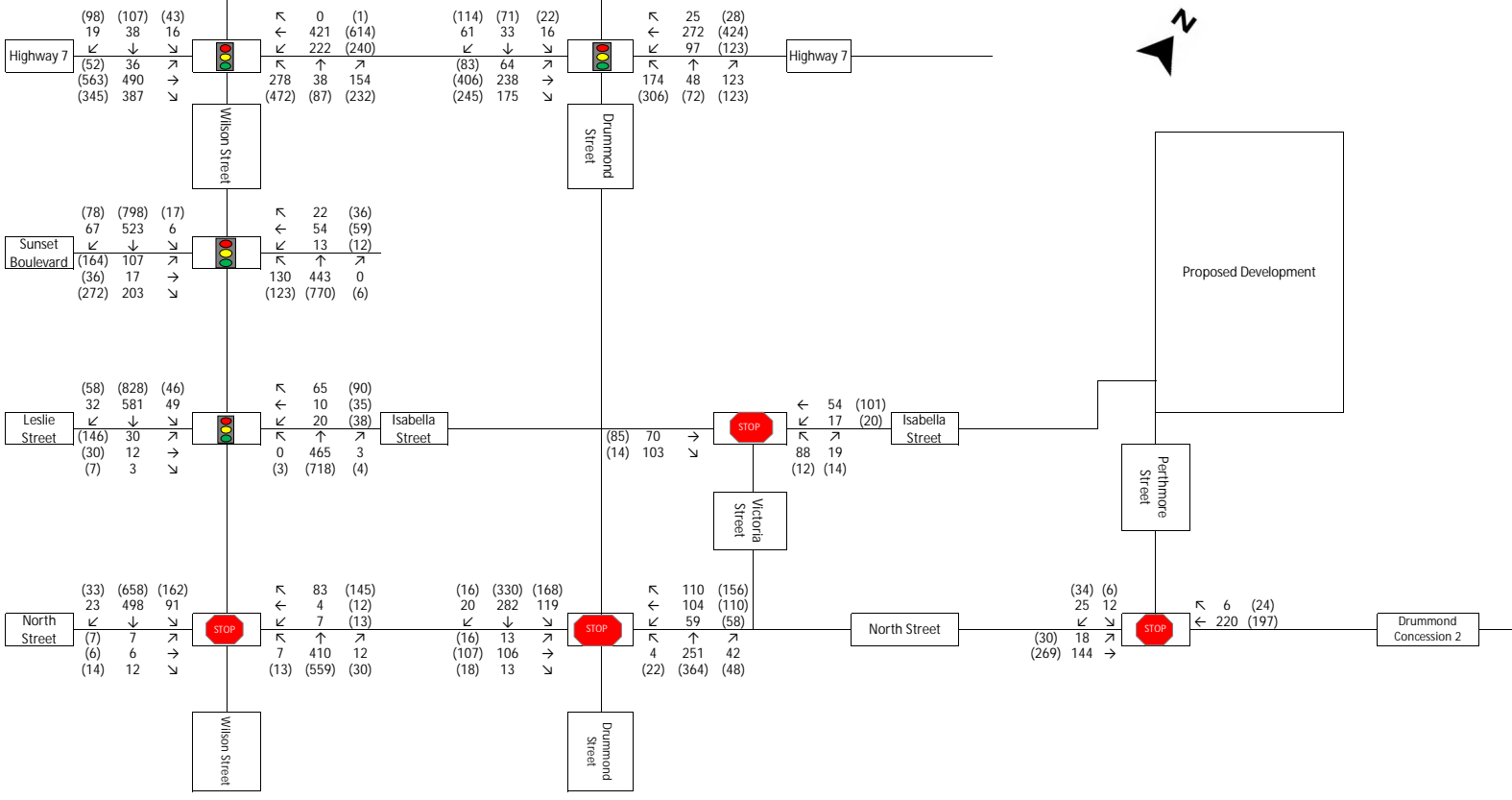

Total Traffic  
Buildout Year 2030  
AM xxx  
PM (xxx)

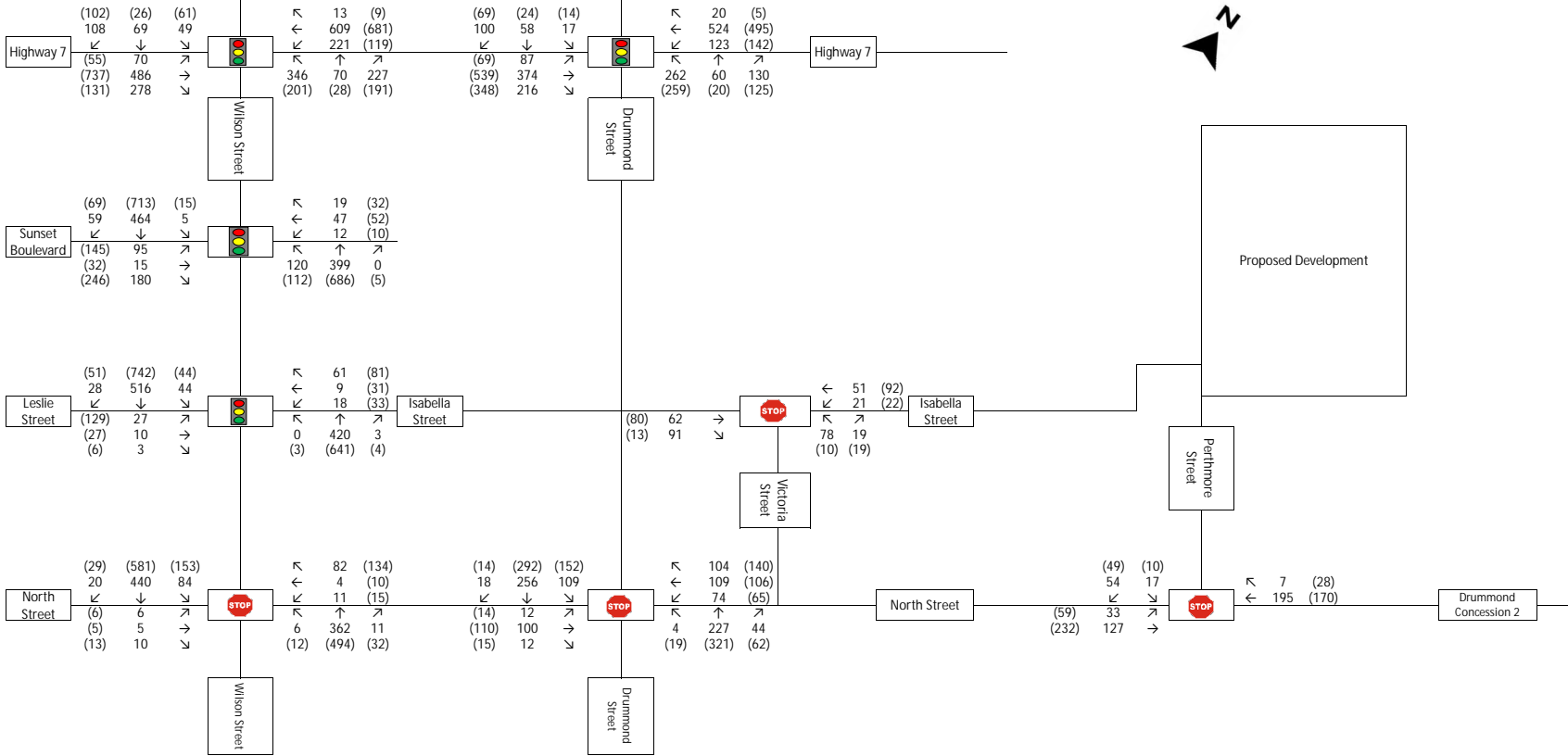

Total Traffic  
Horizon Year 2035  
AM (xxx)  
PM (xxx)

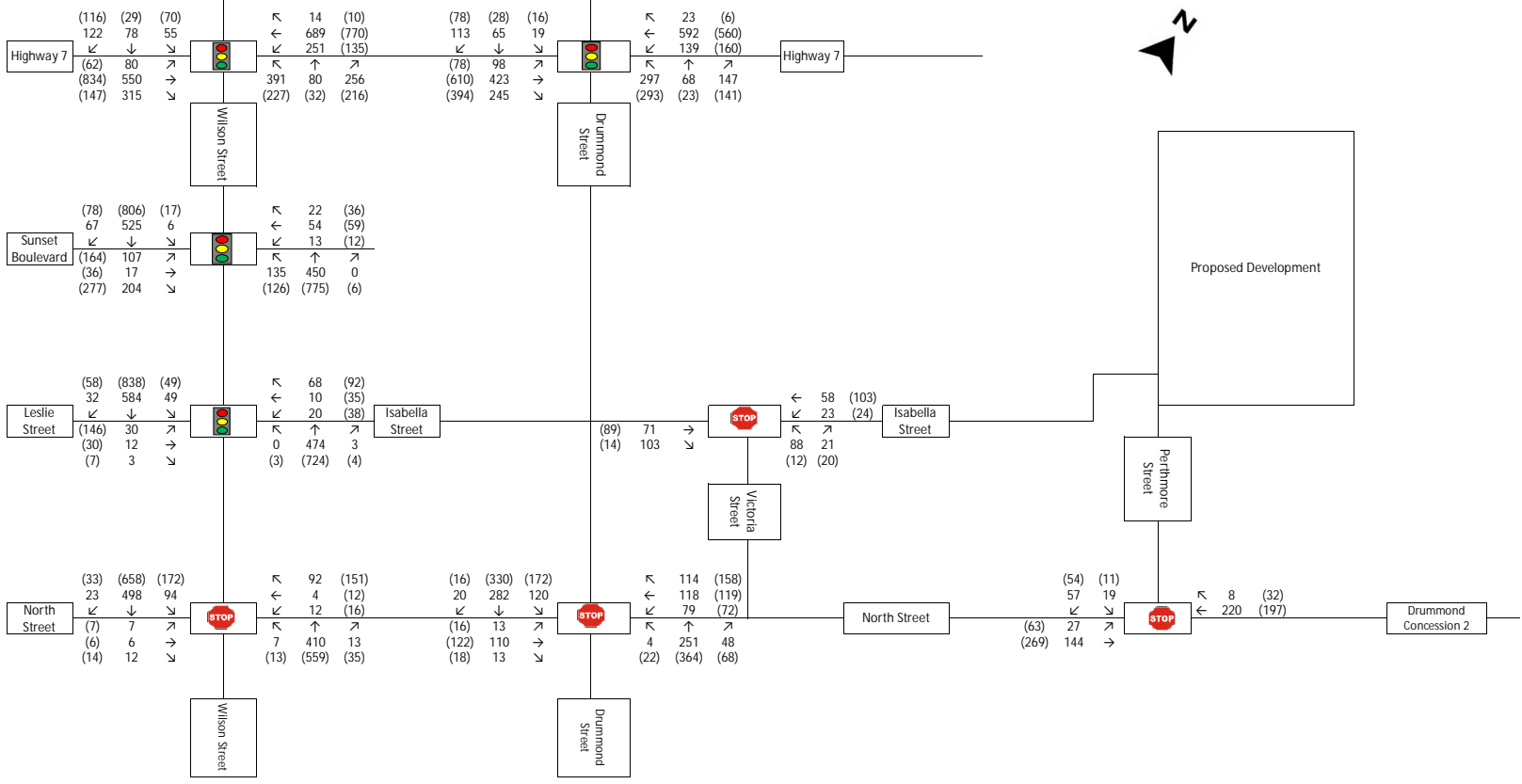

## APPENDIX E – SYNCHRO 10 REPORTS



Perthmore Subdivision TIS  
 12: Wilson Street /Canadian tire Ent/Ext & HWY 7

Existing Conditions 2020  
 AM Peak Hour



Lane Group	EBL	EBT	EBR	WBL	WBT	WBR	NBL	NBT	NBR	SBL	SBT	SBR
Lane Configurations		↕↕			↕↕			↕	↕		↕	↕
Traffic Volume (vph)	55	380	216	173	476	10	265	55	177	38	54	84
Future Volume (vph)	55	380	216	173	476	10	265	55	177	38	54	84
Ideal Flow (vphpl)	1900	1900	1900	1900	1900	1900	1900	1900	1900	1900	1900	1900
Storage Length (m)	0.0		0.0	0.0		0.0	0.0		60.0	30.0		0.0
Storage Lanes	0		0	0		0	0		1	1		1
Taper Length (m)	7.5			7.5			7.5			10.0		
Lane Util. Factor	0.95	0.95	0.95	0.95	0.95	0.95	1.00	1.00	1.00	1.00	1.00	1.00
Ped Bike Factor									0.99		1.00	
Frt		0.950			0.998				0.850			0.850
Flt Protected		0.996			0.987			0.960			0.980	
Satd. Flow (prot)	0	3314	0	0	3406	0	0	1766	1509	0	1783	1583
Flt Permitted		0.813			0.567			0.625			0.730	
Satd. Flow (perm)	0	2705	0	0	1956	0	0	1149	1490	0	1327	1583
Right Turn on Red			Yes			Yes			Yes			Yes
Satd. Flow (RTOR)		80			2				188			91
Link Speed (k/h)		60			60			50			50	
Link Distance (m)		455.2			323.0			474.1			153.4	
Travel Time (s)		27.3			19.4			34.1			11.0	
Confl. Peds. (#/hr)									1	1		
Peak Hour Factor	0.91	0.91	0.91	0.96	0.96	0.96	0.94	0.94	0.94	0.92	0.92	0.92
Heavy Vehicles (%)	0%	3%	4%	0%	6%	5%	4%	0%	7%	8%	2%	2%
Adj. Flow (vph)	60	418	237	180	496	10	282	59	188	41	59	91
Shared Lane Traffic (%)												
Lane Group Flow (vph)	0	715	0	0	686	0	0	341	188	0	100	91
Enter Blocked Intersection	No	No	No	No	No	No	No	No	No	No	No	No
Lane Alignment	Left	Left	Right	Left	Left	Right	Left	Left	Right	Left	Left	Right
Median Width(m)		0.0			0.0			0.0			0.0	
Link Offset(m)		0.0			0.0			0.0			0.0	
Crosswalk Width(m)		4.8			4.8			4.8			4.8	
Two way Left Turn Lane												
Headway Factor	1.00	1.00	1.00	1.00	1.00	1.00	1.00	1.00	1.00	1.00	1.00	1.00
Turning Speed (k/h)	25		15	25		15	25		15	25		15
Number of Detectors	1	2		1	2		1	1	1	1	1	1
Detector Template	Left			Left			Left			Left		
Leading Detector (m)	2.0	98.8		2.0	91.8		2.0	9.0	9.0	2.0	9.0	9.0
Trailing Detector (m)	0.0	-3.0		0.0	-3.0		0.0	-3.0	-3.0	0.0	-0.2	-3.0
Detector 1 Position(m)	0.0	-3.0		0.0	-3.0		0.0	-3.0	-3.0	0.0	-0.2	-3.0
Detector 1 Size(m)	2.0	12.0		2.0	12.0		2.0	12.0	12.0	2.0	9.2	12.0
Detector 1 Type	Cl+Ex	Cl+Ex		Cl+Ex	Cl+Ex		Cl+Ex	Cl+Ex	Cl+Ex	Cl+Ex	Cl+Ex	Cl+Ex
Detector 1 Channel												
Detector 1 Extend (s)	0.0	0.0		0.0	0.0		0.0	0.0	0.0	0.0	0.0	0.0
Detector 1 Queue (s)	0.0	0.0		0.0	0.0		0.0	0.0	0.0	0.0	0.0	0.0
Detector 1 Delay (s)	0.0	0.0		0.0	0.0		0.0	0.0	0.0	0.0	0.0	0.0
Detector 2 Position(m)		97.0			90.0							
Detector 2 Size(m)		1.8			1.8							
Detector 2 Type		Cl+Ex			Cl+Ex							
Detector 2 Channel												
Detector 2 Extend (s)		0.0			0.0							

Perthmore Subdivision TIS  
 12: Wilson Street /Canadian tire Ent/Ext & HWY 7

Existing Conditions 2020  
 AM Peak Hour



Lane Group	EBL	EBT	EBR	WBL	WBT	WBR	NBL	NBT	NBR	SBL	SBT	SBR
Turn Type	Perm	NA		pm+pt	NA		pm+pt	NA	Perm	Perm	NA	Perm
Protected Phases		2		1	6		3	8			4	
Permitted Phases	2			6			8		8	4		4
Detector Phase	2	2		1	1 6		3	3 8	8	4	4	4
Switch Phase												
Minimum Initial (s)	20.0	20.0		7.0	20.0		7.0	10.0	10.0	10.0	10.0	10.0
Minimum Split (s)	43.9	43.9		9.0	43.9		9.0	37.4	37.4	37.4	37.4	37.4
Total Split (s)	43.9	43.9		16.0	59.9		16.0	53.4	53.4	37.4	37.4	37.4
Total Split (%)	38.7%	38.7%		14.1%	52.9%		14.1%	47.1%	47.1%	33.0%	33.0%	33.0%
Maximum Green (s)	37.0	37.0		14.0	53.0		14.0	47.0	47.0	31.0	31.0	31.0
Yellow Time (s)	5.0	5.0		2.0	5.0		2.0	4.1	4.1	4.1	4.1	4.1
All-Red Time (s)	1.9	1.9		0.0	1.9		0.0	2.3	2.3	2.3	2.3	2.3
Lost Time Adjust (s)		0.0			0.0			0.0	0.0		0.0	0.0
Total Lost Time (s)		6.9			6.9			6.4	6.4		6.4	6.4
Lead/Lag	Lag	Lag		Lead			Lead			Lag	Lag	Lag
Lead-Lag Optimize?	Yes	Yes		Yes			Yes			Yes	Yes	Yes
Vehicle Extension (s)	4.5	4.5		2.0	4.5		2.0	3.0	3.0	3.0	3.0	3.0
Recall Mode	Min	Min		None	Min		None	None	None	None	None	None
Walk Time (s)	7.0	7.0			7.0			7.0	7.0	7.0	7.0	7.0
Flash Dont Walk (s)	30.0	30.0			30.0			24.0	24.0	24.0	24.0	24.0
Pedestrian Calls (#/hr)	0	0			0			1	1	0	0	0
Act Effct Green (s)		33.3			49.4			33.6	33.6		17.9	17.9
Actuated g/C Ratio		0.34			0.51			0.35	0.35		0.19	0.19
v/c Ratio		0.73			0.60			0.74	0.29		0.41	0.25
Control Delay		30.3			18.7			37.4	4.4		40.2	8.7
Queue Delay		0.0			0.0			0.0	0.0		0.0	0.0
Total Delay		30.3			18.7			37.4	4.4		40.2	8.7
LOS		C			B			D	A		D	A
Approach Delay		30.3			18.7			25.7			25.2	
Approach LOS		C			B			C			C	

Intersection Summary

Area Type: Other  
 Cycle Length: 113.3  
 Actuated Cycle Length: 96.6  
 Natural Cycle: 100  
 Control Type: Semi Act-Uncoord  
 Maximum v/c Ratio: 0.74  
 Intersection Signal Delay: 24.9  
 Intersection LOS: C  
 Intersection Capacity Utilization 78.6%  
 ICU Level of Service D  
 Analysis Period (min) 15

Splits and Phases: 12: Wilson Street /Canadian tire Ent/Ext & HWY 7

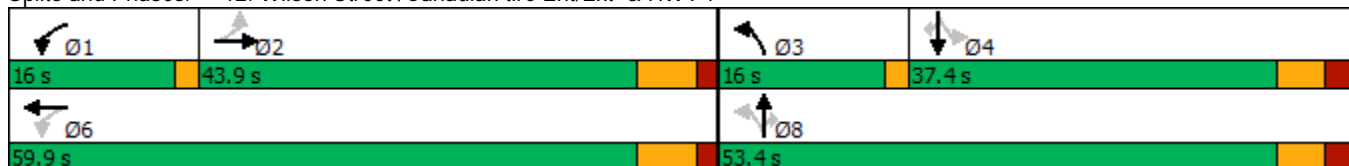

Perthmore Subdivision TIS  
 15: Drummond Street/Dufferin Street & HWY 7

Existing Conditions 2020  
 AM Peak Hour



Lane Group	EBL	EBT	EBR	WBL	WBT	WBR	NBL	NBT	NBR	SBL	SBT	SBR
Lane Configurations		↕↕			↕↕	↗	↖	↗	↖	↖	↗	↗
Traffic Volume (vph)	68	292	169	95	409	16	205	47	98	13	45	78
Future Volume (vph)	68	292	169	95	409	16	205	47	98	13	45	78
Ideal Flow (vphpl)	1900	1900	1900	1900	1900	1900	1900	1900	1900	1900	1900	1900
Storage Length (m)	0.0		0.0	0.0		15.0	65.0		0.0	40.0		0.0
Storage Lanes	0		0	0		1	1		0	1		0
Taper Length (m)	7.5			7.5			0.0			20.0		
Lane Util. Factor	0.95	0.95	0.95	0.95	0.95	1.00	1.00	1.00	1.00	1.00	1.00	1.00
Ped Bike Factor								0.99		1.00		
Frt		0.952				0.850		0.899				0.905
Flt Protected		0.994			0.991		0.950			0.950		
Satd. Flow (prot)	0	3253	0	0	3317	1429	1770	1660	0	1671	1678	0
Flt Permitted		0.793			0.708		0.656			0.651		
Satd. Flow (perm)	0	2595	0	0	2370	1429	1222	1660	0	1144	1678	0
Right Turn on Red			Yes			Yes			Yes			Yes
Satd. Flow (RTOR)		97				37		113				96
Link Speed (k/h)		60			60			50				50
Link Distance (m)		323.0			109.7			376.3				232.6
Travel Time (s)		19.4			6.6			27.1				16.7
Confl. Peds. (#/hr)									1	1		
Peak Hour Factor	0.91	0.91	0.91	0.90	0.90	0.90	0.87	0.87	0.87	0.77	0.77	0.77
Heavy Vehicles (%)	4%	7%	2%	3%	9%	13%	2%	2%	2%	8%	5%	1%
Adj. Flow (vph)	75	321	186	106	454	18	236	54	113	17	58	101
Shared Lane Traffic (%)												
Lane Group Flow (vph)	0	582	0	0	560	18	236	167	0	17	159	0
Enter Blocked Intersection	No	No	No	No	No	No	No	No	No	No	No	No
Lane Alignment	Left	Left	Right	Left	Left	Right	Left	Left	Right	Left	Left	Right
Median Width(m)		0.0			0.0			3.6				3.6
Link Offset(m)		0.0			0.0			0.0				0.0
Crosswalk Width(m)		4.8			4.8			4.8				4.8
Two way Left Turn Lane												
Headway Factor	1.00	1.00	1.00	1.00	1.00	1.00	1.00	1.00	1.00	1.00	1.00	1.00
Turning Speed (k/h)	25		15	25		15	25		15	25		15
Number of Detectors	1	1		1	2	0	1	1		1	1	
Detector Template	Left			Left								
Leading Detector (m)	2.0	94.8		2.0	86.8	0.0	9.0	9.0		9.0	9.0	
Trailing Detector (m)	0.0	93.0		0.0	-1.0	0.0	-3.0	-3.0		-3.0	-3.0	
Detector 1 Position(m)	0.0	93.0		0.0	-1.0	0.0	-3.0	-3.0		-3.0	-3.0	
Detector 1 Size(m)	2.0	1.8		2.0	12.0	30.0	12.0	12.0		12.0	12.0	
Detector 1 Type	Cl+Ex	Cl+Ex		Cl+Ex	Cl+Ex	Cl+Ex	Cl+Ex	Cl+Ex		Cl+Ex	Cl+Ex	
Detector 1 Channel												
Detector 1 Extend (s)	0.0	0.0		0.0	0.0	0.0	0.0	0.0		0.0	0.0	
Detector 1 Queue (s)	0.0	0.0		0.0	0.0	0.0	0.0	0.0		0.0	0.0	
Detector 1 Delay (s)	0.0	0.0		0.0	0.0	0.0	0.0	0.0		0.0	0.0	
Detector 2 Position(m)					85.0							
Detector 2 Size(m)					1.8							
Detector 2 Type					Cl+Ex							
Detector 2 Channel												
Detector 2 Extend (s)					0.0							

Perthmore Subdivision TIS  
 15: Drummond Street/Dufferin Street & HWY 7

Existing Conditions 2020  
 AM Peak Hour



Lane Group	EBL	EBT	EBR	WBL	WBT	WBR	NBL	NBT	NBR	SBL	SBT	SBR
Turn Type	Perm	NA		pm+pt	NA	Perm	Perm	NA		Perm	NA	
Protected Phases		2		1	6			8				4
Permitted Phases	2			6		6	8			4		
Detector Phase	2	2		1	1 6	6	8	8		4		4
Switch Phase												
Minimum Initial (s)	20.0	20.0		7.0	20.0	20.0	10.0	10.0		10.0		10.0
Minimum Split (s)	33.3	33.3		10.0	36.3	36.3	38.3	38.3		38.3		38.3
Total Split (s)	46.3	46.3		13.0	59.3	59.3	38.3	38.3		38.3		38.3
Total Split (%)	47.4%	47.4%		13.3%	60.8%	60.8%	39.2%	39.2%		39.2%		39.2%
Maximum Green (s)	40.0	40.0		10.0	53.0	53.0	32.0	32.0		32.0		32.0
Yellow Time (s)	5.0	5.0		3.0	5.0	5.0	4.1	4.1		4.1		4.1
All-Red Time (s)	1.3	1.3		0.0	1.3	1.3	2.2	2.2		2.2		2.2
Lost Time Adjust (s)		0.0			0.0	0.0	0.0	0.0		0.0		0.0
Total Lost Time (s)		6.3			6.3	6.3	6.3	6.3		6.3		6.3
Lead/Lag	Lag	Lag		Lead								
Lead-Lag Optimize?	Yes	Yes		Yes								
Vehicle Extension (s)	4.6	4.6		3.0	4.6	4.6	3.0	3.0		3.0		3.0
Recall Mode	Min	Min		None	Min	Min	None	None		None		None
Walk Time (s)	7.0	7.0			7.0	7.0	7.0	7.0		7.0		7.0
Flash Dont Walk (s)	20.0	20.0			20.0	20.0	25.0	25.0		25.0		25.0
Pedestrian Calls (#/hr)	0	0			0	0	1	1		0		0
Act Effct Green (s)		22.0			35.2	35.2	18.5	18.5		18.5		18.5
Actuated g/C Ratio		0.33			0.53	0.53	0.28	0.28		0.28		0.28
v/c Ratio		0.63			0.41	0.02	0.70	0.31		0.05		0.30
Control Delay		20.1			11.1	1.8	33.2	8.7		17.7		9.8
Queue Delay		0.0			0.0	0.0	0.0	0.0		0.0		0.0
Total Delay		20.1			11.1	1.8	33.2	8.7		17.7		9.8
LOS		C			B	A	C	A		B		A
Approach Delay		20.1			10.8			23.1				10.6
Approach LOS		C			B			C				B

Intersection Summary

Area Type: Other  
 Cycle Length: 97.6  
 Actuated Cycle Length: 66.6  
 Natural Cycle: 85  
 Control Type: Semi Act-Uncoord  
 Maximum v/c Ratio: 0.70  
 Intersection Signal Delay: 16.7  
 Intersection LOS: B  
 Intersection Capacity Utilization 74.0%  
 ICU Level of Service D  
 Analysis Period (min) 15

Splits and Phases: 15: Drummond Street/Dufferin Street & HWY 7

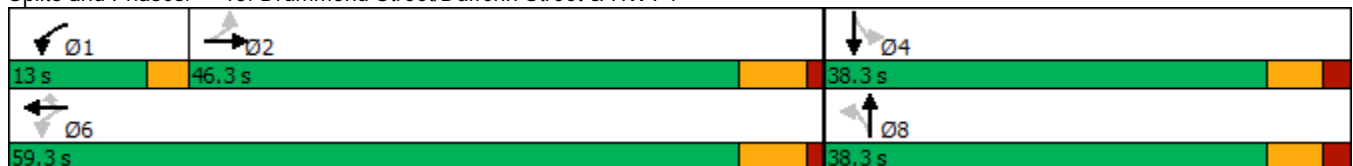

Perthmore Subdivision TIS  
 26: Wilson Street & Sunset Boulevard

Existing Conditions 2020  
 AM Peak Hour



Lane Group	EBL	EBT	EBR	WBL	WBT	WBR	NBL	NBT	NBR	SBL	SBT	SBR
Lane Configurations		↖	↗		↔		↖	↗		↖	↗	↖
Traffic Volume (vph)	74	12	140	9	37	15	90	306	0	4	361	46
Future Volume (vph)	74	12	140	9	37	15	90	306	0	4	361	46
Ideal Flow (vphpl)	1900	1900	1900	1900	1900	1900	1900	1900	1900	1900	1900	1900
Storage Length (m)	0.0		0.0	0.0		0.0	15.0		0.0	25.0		0.0
Storage Lanes	0		1	0		0	1		0	1		1
Taper Length (m)	7.5			7.5			7.5			7.5		
Lane Util. Factor	1.00	1.00	1.00	1.00	1.00	1.00	1.00	1.00	1.00	1.00	1.00	1.00
Ped Bike Factor		0.97	0.98		0.99		0.99			1.00		0.95
Frt			0.850		0.967							0.850
Flt Protected		0.959			0.993		0.950			0.950		
Satd. Flow (prot)	0	1705	1524	0	1768	0	1787	1792	0	1805	1810	1583
Flt Permitted		0.690			0.947		0.358			0.545		
Satd. Flow (perm)	0	1194	1486	0	1685	0	663	1792	0	1032	1810	1500
Right Turn on Red			Yes			Yes			Yes			Yes
Satd. Flow (RTOR)			255		23							113
Link Speed (k/h)		50			50			50				50
Link Distance (m)		147.8			117.2			341.7				188.6
Travel Time (s)		10.6			8.4			24.6				13.6
Confl. Peds. (#/hr)	21		3	3		21	20		4	4		20
Peak Hour Factor	0.55	0.55	0.55	0.64	0.64	0.64	0.85	0.85	0.85	0.86	0.86	0.86
Heavy Vehicles (%)	8%	0%	6%	0%	3%	0%	1%	6%	0%	0%	5%	2%
Adj. Flow (vph)	135	22	255	14	58	23	106	360	0	5	420	53
Shared Lane Traffic (%)												
Lane Group Flow (vph)	0	157	255	0	95	0	106	360	0	5	420	53
Enter Blocked Intersection	No	No	No	No	No	No	No	No	No	No	No	No
Lane Alignment	Left	Left	Right	Left	Left	Right	Left	Left	Right	Left	Left	Right
Median Width(m)		0.0			0.0			3.6				3.6
Link Offset(m)		0.0			0.0			0.0				0.0
Crosswalk Width(m)		4.8			4.8			4.8				4.8
Two way Left Turn Lane												
Headway Factor	1.00	1.00	1.00	1.00	1.00	1.00	1.00	1.00	1.00	1.00	1.00	1.00
Turning Speed (k/h)	25		15	25		15	25		15	25		15
Number of Detectors	1	1	1	1	2		1	2		1	2	1
Detector Template	Left		Right	Left	Thru			Thru			Thru	Right
Leading Detector (m)	2.0	10.0	2.0	2.0	10.0		4.0	10.0		4.0	10.0	2.0
Trailing Detector (m)	0.0	5.0	0.0	0.0	0.0		-1.0	0.0		-1.0	0.0	0.0
Detector 1 Position(m)	0.0	5.0	0.0	0.0	0.0		-1.0	0.0		-1.0	0.0	0.0
Detector 1 Size(m)	2.0	5.0	2.0	2.0	0.6		5.0	0.6		5.0	0.6	2.0
Detector 1 Type	Cl+Ex	Cl+Ex	Cl+Ex	Cl+Ex	Cl+Ex		Cl+Ex	Cl+Ex		Cl+Ex	Cl+Ex	Cl+Ex
Detector 1 Channel												
Detector 1 Extend (s)	0.0	0.0	0.0	0.0	0.0		0.0	0.0		0.0	0.0	0.0
Detector 1 Queue (s)	0.0	0.0	0.0	0.0	0.0		0.0	0.0		0.0	0.0	0.0
Detector 1 Delay (s)	0.0	0.0	0.0	0.0	0.0		0.0	0.0		0.0	0.0	0.0
Detector 2 Position(m)					9.4			9.4				9.4
Detector 2 Size(m)					0.6			0.6				0.6
Detector 2 Type					Cl+Ex			Cl+Ex				Cl+Ex
Detector 2 Channel												
Detector 2 Extend (s)					0.0			0.0				0.0

Perthmore Subdivision TIS  
26: Wilson Street & Sunset Boulevard

Existing Conditions 2020  
AM Peak Hour



Lane Group	EBL	EBT	EBR	WBL	WBT	WBR	NBL	NBT	NBR	SBL	SBT	SBR
Turn Type	Perm	NA	Perm	Perm	NA		pm+pt	NA		pm+pt	NA	Perm
Protected Phases		4			8		5	2		1	6	
Permitted Phases	4		4	8			2			6		6
Detector Phase	4	4	4	8	8		5	2		1	6	6
Switch Phase							2			6		
Minimum Initial (s)	10.0	10.0	10.0	10.0	10.0		5.0	10.0		5.0	10.0	10.0
Minimum Split (s)	22.6	22.6	22.6	22.6	22.6		9.6	22.6		9.6	22.6	22.6
Total Split (s)	22.6	22.6	22.6	22.6	22.6		10.0	27.8		9.6	27.4	27.4
Total Split (%)	37.7%	37.7%	37.7%	37.7%	37.7%		16.7%	46.3%		16.0%	45.7%	45.7%
Maximum Green (s)	18.0	18.0	18.0	18.0	18.0		5.4	23.2		5.0	22.8	22.8
Yellow Time (s)	3.3	3.3	3.3	3.3	3.3		3.3	3.3		3.3	3.3	3.3
All-Red Time (s)	1.3	1.3	1.3	1.3	1.3		1.3	1.3		1.3	1.3	1.3
Lost Time Adjust (s)		0.0	0.0		0.0		0.0	0.0		0.0	0.0	0.0
Total Lost Time (s)		4.6	4.6		4.6		4.6	4.6		4.6	4.6	4.6
Lead/Lag							Lead	Lag		Lead	Lag	Lag
Lead-Lag Optimize?							Yes	Yes		Yes	Yes	Yes
Vehicle Extension (s)	3.0	3.0	3.0	3.0	3.0		3.0	3.0		3.0	3.0	3.0
Recall Mode	None	None	None	None	None		None	Min		None	Min	Min
Walk Time (s)	7.0	7.0	7.0	7.0	7.0			7.0			7.0	7.0
Flash Dont Walk (s)	11.0	11.0	11.0	11.0	11.0			11.0			11.0	11.0
Pedestrian Calls (#/hr)	0	0	0	0	0			0			0	0
Act Effct Green (s)		12.5	12.5		12.5		21.5	20.7		19.5	17.0	17.0
Actuated g/C Ratio		0.28	0.28		0.28		0.48	0.47		0.44	0.38	0.38
v/c Ratio		0.47	0.42		0.19		0.23	0.43		0.01	0.61	0.08
Control Delay		21.0	5.2		13.0		7.1	11.0		6.0	17.1	0.7
Queue Delay		0.0	0.0		0.0		0.0	0.0		0.0	0.0	0.0
Total Delay		21.0	5.2		13.0		7.1	11.0		6.0	17.1	0.7
LOS		C	A		B		A	B		A	B	A
Approach Delay		11.2			13.0			10.1			15.2	
Approach LOS		B			B			B			B	

Intersection Summary

Area Type: Other  
 Cycle Length: 60  
 Actuated Cycle Length: 44.4  
 Natural Cycle: 60  
 Control Type: Semi Act-Uncoord  
 Maximum v/c Ratio: 0.61  
 Intersection Signal Delay: 12.3  
 Intersection LOS: B  
 Intersection Capacity Utilization 51.8%  
 ICU Level of Service A  
 Analysis Period (min) 15

Splits and Phases: 26: Wilson Street & Sunset Boulevard

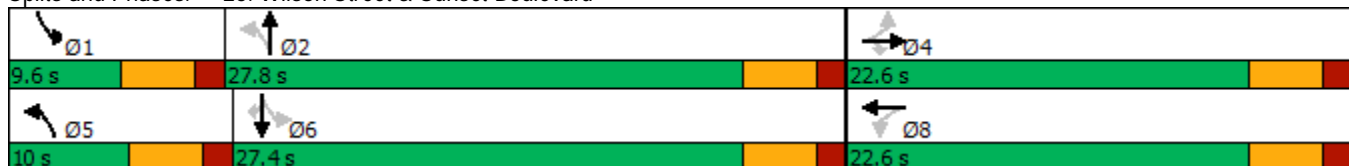



Perthmore Subdivision TIS  
30: Wilson Street & Leslie Street/Isabella Street

Existing Conditions 2020  
AM Peak Hour



Lane Group	EBL	EBT	EBR	WBL	WBT	WBR	NBL	NBT	NBR	SBL	SBT	SBR
Lane Configurations		↕			↕		↗	↘		↗	↘	
Traffic Volume (vph)	21	8	2	14	7	45	0	321	2	34	401	22
Future Volume (vph)	21	8	2	14	7	45	0	321	2	34	401	22
Ideal Flow (vphpl)	1900	1900	1900	1900	1900	1900	1900	1900	1900	1900	1900	1900
Storage Length (m)	0.0		0.0	0.0		0.0	60.0		0.0	25.0		0.0
Storage Lanes	0		0	0		0	1		0	1		0
Taper Length (m)	7.5			7.5			25.0			15.0		
Lane Util. Factor	1.00	1.00	1.00	1.00	1.00	1.00	1.00	1.00	1.00	1.00	1.00	1.00
Ped Bike Factor		0.97			0.95			1.00		0.99	1.00	
Frt		0.990			0.908			0.999			0.992	
Flt Protected		0.967			0.990					0.950		
Satd. Flow (prot)	0	1513	0	0	1565	0	1900	1758	0	1752	1745	0
Flt Permitted		0.751			0.918					0.415		
Satd. Flow (perm)	0	1145	0	0	1449	0	1900	1758	0	758	1745	0
Right Turn on Red			Yes			Yes			Yes			Yes
Satd. Flow (RTOR)		3			63			1			7	
Link Speed (k/h)		50			50			50			50	
Link Distance (m)		91.6			415.9			340.1			341.7	
Travel Time (s)		6.6			29.9			24.5			24.6	
Confl. Peds. (#/hr)	16		3	3		16	4		11	11		4
Peak Hour Factor	0.78	0.78	0.78	0.72	0.72	0.72	0.82	0.82	0.82	0.82	0.82	0.82
Heavy Vehicles (%)	24%	0%	50%	0%	14%	4%	0%	8%	0%	3%	7%	23%
Adj. Flow (vph)	27	10	3	19	10	63	0	391	2	41	489	27
Shared Lane Traffic (%)												
Lane Group Flow (vph)	0	40	0	0	92	0	0	393	0	41	516	0
Enter Blocked Intersection	No	No	No	No	No	No	No	No	No	No	No	No
Lane Alignment	Left	Left	Right	Left	Left	Right	Left	Left	Right	Left	Left	Right
Median Width(m)		0.0			0.0			3.6			3.6	
Link Offset(m)		0.0			0.0			0.0			0.0	
Crosswalk Width(m)		4.8			4.8			4.8			4.8	
Two way Left Turn Lane												
Headway Factor	1.00	1.00	1.00	1.00	1.00	1.00	1.00	1.00	1.00	1.00	1.00	1.00
Turning Speed (k/h)	25		15	25		15	25		15	25		15
Number of Detectors	1	2		1	2		1	2		1	2	
Detector Template	Left	Thru		Left	Thru		Left	Thru		Left	Thru	
Leading Detector (m)	2.0	10.0		2.0	10.0		2.0	10.0		2.0	10.0	
Trailing Detector (m)	0.0	0.0		0.0	0.0		0.0	0.0		0.0	0.0	
Detector 1 Position(m)	0.0	0.0		0.0	0.0		0.0	0.0		0.0	0.0	
Detector 1 Size(m)	2.0	0.6		2.0	0.6		2.0	0.6		2.0	0.6	
Detector 1 Type	Cl+Ex	Cl+Ex		Cl+Ex	Cl+Ex		Cl+Ex	Cl+Ex		Cl+Ex	Cl+Ex	
Detector 1 Channel												
Detector 1 Extend (s)	0.0	0.0		0.0	0.0		0.0	0.0		0.0	0.0	
Detector 1 Queue (s)	0.0	0.0		0.0	0.0		0.0	0.0		0.0	0.0	
Detector 1 Delay (s)	0.0	0.0		0.0	0.0		0.0	0.0		0.0	0.0	
Detector 2 Position(m)		9.4			9.4			9.4			9.4	
Detector 2 Size(m)		0.6			0.6			0.6			0.6	
Detector 2 Type		Cl+Ex			Cl+Ex			Cl+Ex			Cl+Ex	
Detector 2 Channel												
Detector 2 Extend (s)		0.0			0.0			0.0			0.0	

Perthmore Subdivision TIS  
 30: Wilson Street & Leslie Street/Isabella Street

Existing Conditions 2020  
 AM Peak Hour



Lane Group	EBL	EBT	EBR	WBL	WBT	WBR	NBL	NBT	NBR	SBL	SBT	SBR
Turn Type	Perm	NA		Perm	NA		pm+pt	NA		pm+pt	NA	
Protected Phases		4			8		5	2		1	6	
Permitted Phases	4			8			2			6		
Detector Phase	4	4		8	8		5	2		1	6	
Switch Phase							2			6		
Minimum Initial (s)	10.0	10.0		10.0	10.0		5.0	10.0		5.0	10.0	
Minimum Split (s)	15.1	15.1		15.1	15.1		9.6	35.0		9.6	35.0	
Total Split (s)	15.1	15.1		15.1	15.1		9.6	35.3		9.6	35.3	
Total Split (%)	25.2%	25.2%		25.2%	25.2%		16.0%	58.8%		16.0%	58.8%	
Maximum Green (s)	10.5	10.5		10.5	10.5		5.0	30.7		5.0	30.7	
Yellow Time (s)	3.3	3.3		3.3	3.3		3.3	3.3		3.3	3.3	
All-Red Time (s)	1.3	1.3		1.3	1.3		1.3	1.3		1.3	1.3	
Lost Time Adjust (s)		0.0			0.0		0.0	0.0		0.0	0.0	
Total Lost Time (s)		4.6			4.6		4.6	4.6		4.6	4.6	
Lead/Lag							Lead	Lag		Lead	Lag	
Lead-Lag Optimize?							Yes	Yes		Yes	Yes	
Vehicle Extension (s)	3.0	3.0		3.0	3.0		3.0	3.0		3.0	3.0	
Recall Mode	None	None		None	None		None	Min		None	Min	
Walk Time (s)	6.0	6.0		6.0	6.0			7.0			7.0	
Flash Dont Walk (s)	4.5	4.5		4.5	4.5			11.0			11.0	
Pedestrian Calls (#/hr)	0	0		0	0			0			0	
Act Effct Green (s)		10.5			10.5			24.7		25.5	27.8	
Actuated g/C Ratio		0.27			0.27			0.64		0.67	0.73	
v/c Ratio		0.13			0.21			0.35		0.06	0.41	
Control Delay		15.0			9.0			9.4		4.4	5.9	
Queue Delay		0.0			0.0			0.0		0.0	0.0	
Total Delay		15.0			9.0			9.4		4.4	5.9	
LOS		B			A			A		A	A	
Approach Delay		15.0			9.0			9.4			5.8	
Approach LOS		B			A			A			A	

Intersection Summary

Area Type: Other  
 Cycle Length: 60  
 Actuated Cycle Length: 38.3  
 Natural Cycle: 60  
 Control Type: Semi Act-Uncoord  
 Maximum v/c Ratio: 0.41  
 Intersection Signal Delay: 7.7  
 Intersection LOS: A  
 Intersection Capacity Utilization 44.4%  
 ICU Level of Service A  
 Analysis Period (min) 15

Splits and Phases: 30: Wilson Street & Leslie Street/Isabella Street

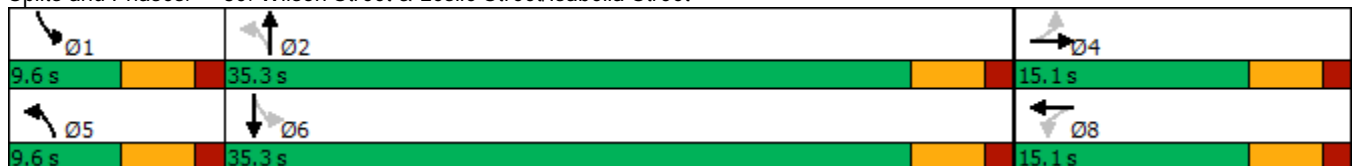

HCM 6th TWSC  
 3: Drummond Concession 2 & Perthmore

Existing Conditions 2020

Intersection						
Int Delay, s/veh	1.2					
Movement	EBL	EBT	WBT	WBR	SBL	SBR
Lane Configurations		↕	↑	↗	↘	
Traffic Vol, veh/h	12	99	152	4	8	17
Future Vol, veh/h	12	99	152	4	8	17
Conflicting Peds, #/hr	0	0	0	0	0	0
Sign Control	Free	Free	Free	Free	Stop	Stop
RT Channelized	-	None	-	None	-	None
Storage Length	-	-	-	250	0	-
Veh in Median Storage, #	-	0	0	-	0	-
Grade, %	-	0	0	-	0	-
Peak Hour Factor	83	83	84	84	78	78
Heavy Vehicles, %	50	9	1	25	0	12
Mvmt Flow	14	119	181	5	10	22

Major/Minor	Major1	Major2	Minor2		
Conflicting Flow All	186	0	0	328	181
Stage 1	-	-	-	181	-
Stage 2	-	-	-	147	-
Critical Hdwy	4.6	-	-	6.4	6.32
Critical Hdwy Stg 1	-	-	-	5.4	-
Critical Hdwy Stg 2	-	-	-	5.4	-
Follow-up Hdwy	2.65	-	-	3.5	3.408
Pot Cap-1 Maneuver	1146	-	-	671	837
Stage 1	-	-	-	855	-
Stage 2	-	-	-	885	-
Platoon blocked, %	-	-	-	-	-
Mov Cap-1 Maneuver	1146	-	-	662	837
Mov Cap-2 Maneuver	-	-	-	662	-
Stage 1	-	-	-	844	-
Stage 2	-	-	-	885	-

Approach	EB	WB	SB
HCM Control Delay, s	0.9	0	9.9
HCM LOS			A

Minor Lane/Major Mvmt	EBL	EBT	WBT	WBR	SBLn1
Capacity (veh/h)	1146	-	-	-	772
HCM Lane V/C Ratio	0.013	-	-	-	0.042
HCM Control Delay (s)	8.2	0	-	-	9.9
HCM Lane LOS	A	A	-	-	A
HCM 95th %tile Q(veh)	0	-	-	-	0.1

Intersection						
Int Delay, s/veh	4.8					
Movement	EBT	EBR	WBL	WBT	NBL	NBR
Lane Configurations						
Traffic Vol, veh/h	48	71	12	37	61	13
Future Vol, veh/h	48	71	12	37	61	13
Conflicting Peds, #/hr	0	0	0	0	0	19
Sign Control	Free	Free	Free	Free	Stop	Stop
RT Channelized	-	None	-	None	-	None
Storage Length	-	-	-	-	0	-
Veh in Median Storage, #	0	-	-	0	0	-
Grade, %	0	-	-	0	0	-
Peak Hour Factor	63	63	68	68	41	41
Heavy Vehicles, %	2	25	17	8	3	15
Mvmt Flow	76	113	18	54	149	32

Major/Minor	Major1	Major2	Minor1		
Conflicting Flow All	0	0	189	0	223
Stage 1	-	-	-	-	133
Stage 2	-	-	-	-	90
Critical Hdwy	-	-	4.27	-	6.43
Critical Hdwy Stg 1	-	-	-	-	5.43
Critical Hdwy Stg 2	-	-	-	-	5.43
Follow-up Hdwy	-	-	2.353	-	3.527
Pot Cap-1 Maneuver	-	-	1300	-	763
Stage 1	-	-	-	-	891
Stage 2	-	-	-	-	931
Platoon blocked, %	-	-	-	-	-
Mov Cap-1 Maneuver	-	-	1300	-	752
Mov Cap-2 Maneuver	-	-	-	-	752
Stage 1	-	-	-	-	891
Stage 2	-	-	-	-	918

Approach	EB	WB	NB
HCM Control Delay, s	0	1.9	11.1
HCM LOS			B

Minor Lane/Major Mvmt	NBLn1	EBT	EBR	WBL	WBT
Capacity (veh/h)	767	-	-	1300	-
HCM Lane V/C Ratio	0.235	-	-	0.014	-
HCM Control Delay (s)	11.1	-	-	7.8	0
HCM Lane LOS	B	-	-	A	A
HCM 95th %tile Q(veh)	0.9	-	-	0	-

HCM 6th TWSC  
 34: Wilson Street & North Street

Existing Conditions 2020

Intersection												
Int Delay, s/veh	2.4											
Movement	EBL	EBT	EBR	WBL	WBT	WBR	NBL	NBT	NBR	SBL	SBT	SBR
Lane Configurations		↕			↕			↕			↕	
Traffic Vol, veh/h	5	4	8	5	3	57	5	283	8	63	344	16
Future Vol, veh/h	5	4	8	5	3	57	5	283	8	63	344	16
Conflicting Peds, #/hr	2	0	2	2	0	2	9	0	7	7	0	9
Sign Control	Stop	Stop	Stop	Stop	Stop	Stop	Free	Free	Free	Free	Free	Free
RT Channelized	-	-	None	-	-	None	-	-	None	-	-	None
Storage Length	-	-	-	-	-	-	-	-	-	-	-	650
Veh in Median Storage, #	-	0	-	-	0	-	-	0	-	-	0	-
Grade, %	-	0	-	-	0	-	-	0	-	-	0	-
Peak Hour Factor	71	71	71	77	77	77	89	89	89	79	79	79
Heavy Vehicles, %	20	0	0	0	0	28	0	6	0	29	2	25
Mvmt Flow	7	6	11	6	4	74	6	318	9	80	435	20

Major/Minor	Minor2		Minor1		Major1			Major2				
Conflicting Flow All	990	960	239	725	966	332	464	0	0	334	0	0
Stage 1	614	614	-	342	342	-	-	-	-	-	-	-
Stage 2	376	346	-	383	624	-	-	-	-	-	-	-
Critical Hdwy	7.6	6.5	6.9	7.3	6.5	6.62	4.1	-	-	4.535	-	-
Critical Hdwy Stg 1	6.8	5.5	-	6.1	5.5	-	-	-	-	-	-	-
Critical Hdwy Stg 2	6.4	5.5	-	6.5	5.5	-	-	-	-	-	-	-
Follow-up Hdwy	3.69	4	3.3	3.5	4	3.566	2.2	-	-	2.4755	-	-
Pot Cap-1 Maneuver	192	259	768	330	257	643	1108	-	-	1069	-	-
Stage 1	412	486	-	677	642	-	-	-	-	-	-	-
Stage 2	603	639	-	617	481	-	-	-	-	-	-	-
Platoon blocked, %								-	-	-	-	-
Mov Cap-1 Maneuver	152	228	761	291	226	638	1100	-	-	1063	-	-
Mov Cap-2 Maneuver	152	228	-	291	226	-	-	-	-	-	-	-
Stage 1	406	434	-	668	634	-	-	-	-	-	-	-
Stage 2	525	631	-	538	429	-	-	-	-	-	-	-

Approach	EB		WB		NB		SB	
HCM Control Delay, s	19.1		12.8		0.1		1.5	
HCM LOS	C		B					

Minor Lane/Major Mvmt	NBL	NBT	NBR	EBLn1WBLn1	SBL	SBT	SBR
Capacity (veh/h)	1100	-	-	279	543	1063	-
HCM Lane V/C Ratio	0.005	-	-	0.086	0.155	0.075	-
HCM Control Delay (s)	8.3	0	-	19.1	12.8	8.7	0.3
HCM Lane LOS	A	A	-	C	B	A	A
HCM 95th %tile Q(veh)	0	-	-	0.3	0.5	0.2	-

Intersection	
Intersection Delay, s/veh	13
Intersection LOS	B

Movement	EBL	EBT	EBR	WBL	WBT	WBR	NBL	NBT	NBR	SBL	SBT	SBR
Lane Configurations		↕			↕			↕			↕	
Traffic Vol, veh/h	9	75	9	42	74	78	3	177	30	84	200	14
Future Vol, veh/h	9	75	9	42	74	78	3	177	30	84	200	14
Peak Hour Factor	0.67	0.67	0.67	0.88	0.88	0.88	0.90	0.90	0.90	0.78	0.78	0.78
Heavy Vehicles, %	0	16	0	0	14	0	0	2	3	1	3	7
Mvmt Flow	13	112	13	48	84	89	3	197	33	108	256	18
Number of Lanes	0	1	0	0	1	0	0	1	0	0	1	0

Approach	EB	WB	NB	SB
Opposing Approach	WB	EB	SB	NB
Opposing Lanes	1	1	1	1
Conflicting Approach Left	SB	NB	EB	WB
Conflicting Lanes Left	1	1	1	1
Conflicting Approach Right	NB	SB	WB	EB
Conflicting Lanes Right	1	1	1	1
HCM Control Delay	10.8	11.7	11.6	15.4
HCM LOS	B	B	B	C

Lane	NBLn1	EBLn1	WBLn1	SBLn1
Vol Left, %	1%	10%	22%	28%
Vol Thru, %	84%	81%	38%	67%
Vol Right, %	14%	10%	40%	5%
Sign Control	Stop	Stop	Stop	Stop
Traffic Vol by Lane	210	93	194	298
LT Vol	3	9	42	84
Through Vol	177	75	74	200
RT Vol	30	9	78	14
Lane Flow Rate	233	139	220	382
Geometry Grp	1	1	1	1
Degree of Util (X)	0.356	0.23	0.345	0.571
Departure Headway (Hd)	5.49	5.959	5.639	5.379
Convergence, Y/N	Yes	Yes	Yes	Yes
Cap	651	600	635	669
Service Time	3.55	4.031	3.704	3.431
HCM Lane V/C Ratio	0.358	0.232	0.346	0.571
HCM Control Delay	11.6	10.8	11.7	15.4
HCM Lane LOS	B	B	B	C
HCM 95th-tile Q	1.6	0.9	1.5	3.6



Perthmore Subdivision TIS  
 12: Wilson Street /Canadian tire Ent/Ext & HWY 7

Existing Conditions 2020  
 PM Peak Hour



Lane Group	EBL	EBT	EBR	WBL	WBT	WBR	NBL	NBT	NBR	SBL	SBT	SBR
Lane Configurations		↕↕			↕↕			↕	↗		↕	↗
Traffic Volume (vph)	43	576	96	93	532	7	153	22	149	48	20	80
Future Volume (vph)	43	576	96	93	532	7	153	22	149	48	20	80
Ideal Flow (vphpl)	1900	1900	1900	1900	1900	1900	1900	1900	1900	1900	1900	1900
Storage Length (m)	0.0		0.0	0.0		0.0	0.0		60.0	30.0		0.0
Storage Lanes	0		0	0		0	0		1	1		1
Taper Length (m)	7.5			7.5			7.5			10.0		
Lane Util. Factor	0.95	0.95	0.95	0.95	0.95	0.95	1.00	1.00	1.00	1.00	1.00	1.00
Ped Bike Factor								1.00				0.99
Frt		0.980			0.998				0.850			0.850
Flt Protected		0.997			0.993			0.958			0.966	
Satd. Flow (prot)	0	3399	0	0	3419	0	0	1759	1509	0	1835	1615
Flt Permitted		0.848			0.602			0.587			0.644	
Satd. Flow (perm)	0	2891	0	0	2072	0	0	1076	1509	0	1224	1592
Right Turn on Red			Yes			Yes			Yes			Yes
Satd. Flow (RTOR)		16			1				213			86
Link Speed (k/h)		60			60			50			50	
Link Distance (m)		455.2			323.0			476.0			562.7	
Travel Time (s)		27.3			19.4			34.3			40.5	
Confl. Peds. (#/hr)							2					2
Peak Hour Factor	0.82	0.82	0.82	0.87	0.87	0.87	0.70	0.70	0.70	0.93	0.93	0.93
Heavy Vehicles (%)	0%	4%	4%	3%	5%	0%	4%	0%	7%	0%	0%	0%
Adj. Flow (vph)	52	702	117	107	611	8	219	31	213	52	22	86
Shared Lane Traffic (%)												
Lane Group Flow (vph)	0	871	0	0	726	0	0	250	213	0	74	86
Enter Blocked Intersection	No	No	No	No	No	No	No	No	No	No	No	No
Lane Alignment	Left	Left	Right	Left	Left	Right	Left	Left	Right	Left	Left	Right
Median Width(m)		0.0			0.0			0.0			0.0	
Link Offset(m)		0.0			0.0			0.0			0.0	
Crosswalk Width(m)		4.8			4.8			4.8			4.8	
Two way Left Turn Lane												
Headway Factor	1.00	1.00	1.00	1.00	1.00	1.00	1.00	1.00	1.00	1.00	1.00	1.00
Turning Speed (k/h)	25		15	25		15	25		15	25		15
Number of Detectors	1	2		1	2		1	1	1	1	1	1
Detector Template	Left			Left			Left			Left		
Leading Detector (m)	2.0	98.8		2.0	91.8		2.0	9.0	9.0	2.0	9.0	9.0
Trailing Detector (m)	0.0	-3.0		0.0	-3.0		0.0	-3.0	-3.0	0.0	-0.2	-3.0
Detector 1 Position(m)	0.0	-3.0		0.0	-3.0		0.0	-3.0	-3.0	0.0	-0.2	-3.0
Detector 1 Size(m)	2.0	12.0		2.0	12.0		2.0	12.0	12.0	2.0	9.2	12.0
Detector 1 Type	Cl+Ex	Cl+Ex		Cl+Ex	Cl+Ex		Cl+Ex	Cl+Ex	Cl+Ex	Cl+Ex	Cl+Ex	Cl+Ex
Detector 1 Channel												
Detector 1 Extend (s)	0.0	0.0		0.0	0.0		0.0	0.0	0.0	0.0	0.0	0.0
Detector 1 Queue (s)	0.0	0.0		0.0	0.0		0.0	0.0	0.0	0.0	0.0	0.0
Detector 1 Delay (s)	0.0	0.0		0.0	0.0		0.0	0.0	0.0	0.0	0.0	0.0
Detector 2 Position(m)		97.0			90.0							
Detector 2 Size(m)		1.8			1.8							
Detector 2 Type		Cl+Ex			Cl+Ex							
Detector 2 Channel												
Detector 2 Extend (s)		0.0			0.0							

Perthmore Subdivision TIS  
 12: Wilson Street /Canadian tire Ent/Ext & HWY 7

Existing Conditions 2020  
 PM Peak Hour



Lane Group	EBL	EBT	EBR	WBL	WBT	WBR	NBL	NBT	NBR	SBL	SBT	SBR
Turn Type	Perm	NA		pm+pt	NA		pm+pt	NA	Perm	Perm	NA	Perm
Protected Phases		2		1	6		3	8			4	
Permitted Phases	2			6			8		8	4		4
Detector Phase	2	2		1	1 6		3	3 8	8	4	4	4
Switch Phase												
Minimum Initial (s)	20.0	20.0		7.0	20.0		7.0	10.0	10.0	10.0	10.0	10.0
Minimum Split (s)	43.9	43.9		9.0	43.9		9.0	37.4	37.4	37.4	37.4	37.4
Total Split (s)	43.9	43.9		16.0	59.9		16.0	53.4	53.4	37.4	37.4	37.4
Total Split (%)	38.7%	38.7%		14.1%	52.9%		14.1%	47.1%	47.1%	33.0%	33.0%	33.0%
Maximum Green (s)	37.0	37.0		14.0	53.0		14.0	47.0	47.0	31.0	31.0	31.0
Yellow Time (s)	5.0	5.0		2.0	5.0		2.0	4.1	4.1	4.1	4.1	4.1
All-Red Time (s)	1.9	1.9		0.0	1.9		0.0	2.3	2.3	2.3	2.3	2.3
Lost Time Adjust (s)		0.0			0.0			0.0	0.0		0.0	0.0
Total Lost Time (s)		6.9			6.9			6.4	6.4		6.4	6.4
Lead/Lag	Lag	Lag		Lead			Lead			Lag	Lag	Lag
Lead-Lag Optimize?	Yes	Yes		Yes			Yes			Yes	Yes	Yes
Vehicle Extension (s)	4.5	4.5		2.0	4.5		2.0	3.0	3.0	3.0	3.0	3.0
Recall Mode	Min	Min		None	Min		None	None	None	None	None	None
Walk Time (s)	7.0	7.0			7.0			7.0	7.0	7.0	7.0	7.0
Flash Dont Walk (s)	30.0	30.0			30.0			24.0	24.0	24.0	24.0	24.0
Pedestrian Calls (#/hr)	0	0			0			1	1	0	0	0
Act Effct Green (s)		36.7			52.8			26.0	26.0		12.7	12.7
Actuated g/C Ratio		0.40			0.57			0.28	0.28		0.14	0.14
v/c Ratio		0.75			0.55			0.65	0.37		0.44	0.29
Control Delay		29.6			13.9			36.3	5.4		46.2	10.9
Queue Delay		0.0			0.0			0.0	0.0		0.0	0.0
Total Delay		29.6			13.9			36.3	5.4		46.2	10.9
LOS		C			B			D	A		D	B
Approach Delay		29.6			13.9			22.1			27.2	
Approach LOS		C			B			C			C	

Intersection Summary

Area Type: Other  
 Cycle Length: 113.3  
 Actuated Cycle Length: 92.2  
 Natural Cycle: 100  
 Control Type: Semi Act-Uncoord  
 Maximum v/c Ratio: 0.75  
 Intersection Signal Delay: 22.7  
 Intersection LOS: C  
 Intersection Capacity Utilization 71.0%  
 ICU Level of Service C  
 Analysis Period (min) 15

Splits and Phases: 12: Wilson Street /Canadian tire Ent/Ext & HWY 7

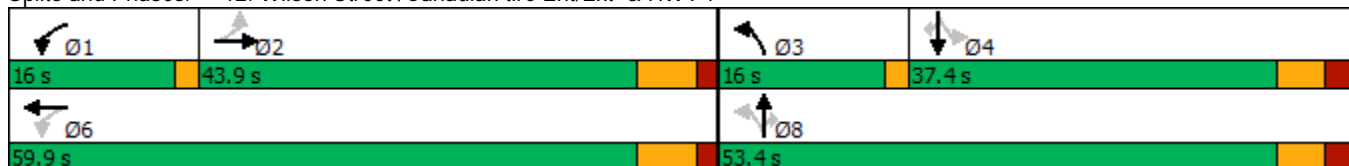

Perthmore Subdivision TIS  
 15: Drummond Street/Dufferin Street & HWY 7

Existing Conditions 2020  
 PM Peak Hour



Lane Group	EBL	EBT	EBR	WBL	WBT	WBR	NBL	NBT	NBR	SBL	SBT	SBR
Lane Configurations		↕↕			↕↕	↗	↖	↗	↖	↖	↗	↗
Traffic Volume (vph)	54	421	272	107	387	4	202	16	95	11	19	54
Future Volume (vph)	54	421	272	107	387	4	202	16	95	11	19	54
Ideal Flow (vphpl)	1900	1900	1900	1900	1900	1900	1900	1900	1900	1900	1900	1900
Storage Length (m)	0.0		0.0	0.0		15.0	65.0		0.0	40.0		0.0
Storage Lanes	0		0	0		1	1		0	1		0
Taper Length (m)	7.5			7.5			0.0			20.0		
Lane Util. Factor	0.95	0.95	0.95	0.95	0.95	1.00	1.00	1.00	1.00	1.00	1.00	1.00
Ped Bike Factor							1.00	0.99		1.00	0.99	
Frt		0.945				0.850		0.871			0.889	
Flt Protected		0.996			0.989		0.950			0.950		
Satd. Flow (prot)	0	3264	0	0	3436	1615	1787	1608	0	1805	1649	0
Flt Permitted		0.862			0.579		0.695			0.676		
Satd. Flow (perm)	0	2825	0	0	2011	1615	1306	1608	0	1282	1649	0
Right Turn on Red			Yes			Yes			Yes			Yes
Satd. Flow (RTOR)		148				37		108			70	
Link Speed (k/h)		60			60			50			50	
Link Distance (m)		323.0			159.9			376.3			222.4	
Travel Time (s)		19.4			9.6			27.1			16.0	
Confl. Peds. (#/hr)							1		2	2		1
Peak Hour Factor	0.81	0.81	0.81	0.94	0.94	0.94	0.88	0.88	0.88	0.77	0.77	0.77
Heavy Vehicles (%)	2%	7%	0%	0%	5%	0%	1%	0%	2%	0%	0%	2%
Adj. Flow (vph)	67	520	336	114	412	4	230	18	108	14	25	70
Shared Lane Traffic (%)												
Lane Group Flow (vph)	0	923	0	0	526	4	230	126	0	14	95	0
Enter Blocked Intersection	No	No	No	No	No	No	No	No	No	No	No	No
Lane Alignment	Left	Left	Right	Left	Left	Right	Left	Left	Right	Left	Left	Right
Median Width(m)		0.0			0.0			3.6			3.6	
Link Offset(m)		0.0			0.0			0.0			0.0	
Crosswalk Width(m)		4.8			4.8			4.8			4.8	
Two way Left Turn Lane												
Headway Factor	1.00	1.00	1.00	1.00	1.00	1.00	1.00	1.00	1.00	1.00	1.00	1.00
Turning Speed (k/h)	25		15	25		15	25		15	25		15
Number of Detectors	1	1		1	2	0	1	1		1	1	
Detector Template	Left			Left		Right						
Leading Detector (m)	2.0	94.8		2.0	86.8	0.0	9.0	9.0		9.0	9.0	
Trailing Detector (m)	0.0	93.0		0.0	-1.0	0.0	-3.0	-3.0		-3.0	-3.0	
Detector 1 Position(m)	0.0	93.0		0.0	-1.0	0.0	-3.0	-3.0		-3.0	-3.0	
Detector 1 Size(m)	2.0	1.8		2.0	12.0	2.0	12.0	12.0		12.0	12.0	
Detector 1 Type	Cl+Ex	Cl+Ex		Cl+Ex	Cl+Ex	Cl+Ex	Cl+Ex	Cl+Ex		Cl+Ex	Cl+Ex	
Detector 1 Channel												
Detector 1 Extend (s)	0.0	0.0		0.0	0.0	0.0	0.0	0.0		0.0	0.0	
Detector 1 Queue (s)	0.0	0.0		0.0	0.0	0.0	0.0	0.0		0.0	0.0	
Detector 1 Delay (s)	0.0	0.0		0.0	0.0	0.0	0.0	0.0		0.0	0.0	
Detector 2 Position(m)					85.0							
Detector 2 Size(m)					1.8							
Detector 2 Type					Cl+Ex							
Detector 2 Channel												
Detector 2 Extend (s)					0.0							

Perthmore Subdivision TIS  
 15: Drummond Street/Dufferin Street & HWY 7

Existing Conditions 2020  
 PM Peak Hour



Lane Group	EBL	EBT	EBR	WBL	WBT	WBR	NBL	NBT	NBR	SBL	SBT	SBR
Turn Type	Perm	NA		pm+pt	NA	Perm	Perm	NA		Perm	NA	
Protected Phases		2		1	6			8				4
Permitted Phases	2			6		6	8			4		
Detector Phase	2	2		1	1 6	6	8	8		4		4
Switch Phase												
Minimum Initial (s)	20.0	20.0		7.0	20.0	20.0	10.0	10.0		10.0		10.0
Minimum Split (s)	33.3	33.3		10.0	36.3	36.3	38.3	38.3		38.3		38.3
Total Split (s)	46.3	46.3		10.0	59.3	59.3	38.3	38.3		38.3		38.3
Total Split (%)	47.4%	47.4%		10.2%	60.8%	60.8%	39.2%	39.2%		39.2%		39.2%
Maximum Green (s)	40.0	40.0		7.0	53.0	53.0	32.0	32.0		32.0		32.0
Yellow Time (s)	5.0	5.0		3.0	5.0	5.0	4.1	4.1		4.1		4.1
All-Red Time (s)	1.3	1.3		0.0	1.3	1.3	2.2	2.2		2.2		2.2
Lost Time Adjust (s)		0.0			0.0	0.0	0.0	0.0		0.0		0.0
Total Lost Time (s)		6.3			6.3	6.3	6.3	6.3		6.3		6.3
Lead/Lag	Lag	Lag		Lead								
Lead-Lag Optimize?	Yes	Yes		Yes								
Vehicle Extension (s)	4.6	4.6		3.0	4.6	4.6	3.0	3.0		3.0		3.0
Recall Mode	Min	Min		None	Min	Min	None	None		None		None
Walk Time (s)	7.0	7.0			7.0	7.0	7.0	7.0		7.0		7.0
Flash Dont Walk (s)	20.0	20.0			20.0	20.0	25.0	25.0		25.0		25.0
Pedestrian Calls (#/hr)	0	0			0	0	1	1		0		0
Act Effct Green (s)		26.6			37.0	37.0	18.4	18.4		18.4		18.4
Actuated g/C Ratio		0.39			0.54	0.54	0.27	0.27		0.27		0.27
v/c Ratio		0.78			0.45	0.00	0.66	0.25		0.04		0.19
Control Delay		21.2			11.3	0.0	32.7	7.6		20.2		9.4
Queue Delay		0.0			0.0	0.0	0.0	0.0		0.0		0.0
Total Delay		21.2			11.3	0.0	32.7	7.6		20.2		9.4
LOS		C			B	A	C	A		C		A
Approach Delay		21.2			11.2			23.8				10.8
Approach LOS		C			B			C				B

Intersection Summary

Area Type: Other  
 Cycle Length: 97.6  
 Actuated Cycle Length: 68.6  
 Natural Cycle: 85  
 Control Type: Semi Act-Uncoord  
 Maximum v/c Ratio: 0.78  
 Intersection Signal Delay: 18.3  
 Intersection LOS: B  
 Intersection Capacity Utilization 72.8%  
 ICU Level of Service C  
 Analysis Period (min) 15

Splits and Phases: 15: Drummond Street/Dufferin Street & HWY 7

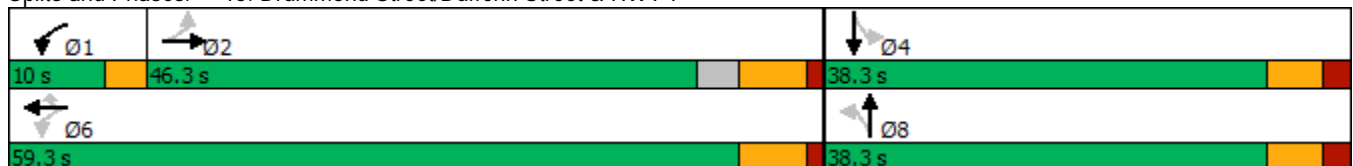

Perthmore Subdivision TIS  
26: Wilson Street & Sunset Boulevard

Existing Conditions 2020  
PM Peak Hour



Lane Group	EBL	EBT	EBR	WBL	WBT	WBR	NBL	NBT	NBR	SBL	SBT	SBR
Lane Configurations		↖	↗		↔		↖	↗		↖	↗	↖
Traffic Volume (vph)	113	25	188	8	41	25	85	532	4	12	551	54
Future Volume (vph)	113	25	188	8	41	25	85	532	4	12	551	54
Ideal Flow (vphpl)	1900	1900	1900	1900	1900	1900	1900	1900	1900	1900	1900	1900
Storage Length (m)	0.0		0.0	0.0		0.0	15.0		0.0	25.0		0.0
Storage Lanes	0		1	0		0	1		0	1		1
Taper Length (m)	7.5			7.5			7.5			7.5		
Lane Util. Factor	1.00	1.00	1.00	1.00	1.00	1.00	1.00	1.00	1.00	1.00	1.00	1.00
Ped Bike Factor		0.98	0.95		0.98		0.99	1.00		0.99		0.93
Frt			0.850		0.955			0.999				0.850
Flt Protected		0.961			0.995		0.950			0.950		
Satd. Flow (prot)	0	1728	1583	0	1756	0	1770	1843	0	1805	1863	1615
Flt Permitted		0.780			0.963		0.196			0.330		
Satd. Flow (perm)	0	1373	1510	0	1695	0	361	1843	0	623	1863	1501
Right Turn on Red			Yes			Yes			Yes			Yes
Satd. Flow (RTOR)			202		32			1				113
Link Speed (k/h)		50			50			50				50
Link Distance (m)		238.8			244.8			341.7				186.6
Travel Time (s)		17.2			17.6			24.6				13.4
Confl. Peds. (#/hr)	18		16	16		18	31		14	14		31
Peak Hour Factor	0.93	0.93	0.93	0.77	0.77	0.77	0.87	0.87	0.87	0.83	0.83	0.83
Heavy Vehicles (%)	6%	4%	2%	0%	2%	0%	2%	3%	0%	0%	2%	0%
Adj. Flow (vph)	122	27	202	10	53	32	98	611	5	14	664	65
Shared Lane Traffic (%)												
Lane Group Flow (vph)	0	149	202	0	95	0	98	616	0	14	664	65
Enter Blocked Intersection	No	No	No	No	No	No	No	No	No	No	No	No
Lane Alignment	Left	Left	Right	Left	Left	Right	Left	Left	Right	Left	Left	Right
Median Width(m)		0.0			0.0			3.6			3.6	
Link Offset(m)		0.0			0.0			0.0			0.0	
Crosswalk Width(m)		4.8			4.8			4.8			4.8	
Two way Left Turn Lane												
Headway Factor	1.00	1.00	1.00	1.00	1.00	1.00	1.00	1.00	1.00	1.00	1.00	1.00
Turning Speed (k/h)	25		15	25		15	25		15	25		15
Number of Detectors	1	1	1	1	2		1	2		1	2	1
Detector Template	Left		Right	Left	Thru			Thru			Thru	Right
Leading Detector (m)	2.0	10.0	2.0	2.0	10.0		3.0	10.0		3.0	10.0	2.0
Trailing Detector (m)	0.0	5.0	0.0	0.0	0.0		-1.0	0.0		-1.0	0.0	0.0
Detector 1 Position(m)	0.0	5.0	0.0	0.0	0.0		-1.0	0.0		-1.0	0.0	0.0
Detector 1 Size(m)	2.0	5.0	2.0	2.0	0.6		4.0	0.6		4.0	0.6	2.0
Detector 1 Type	Cl+Ex	Cl+Ex	Cl+Ex	Cl+Ex	Cl+Ex		Cl+Ex	Cl+Ex		Cl+Ex	Cl+Ex	Cl+Ex
Detector 1 Channel												
Detector 1 Extend (s)	0.0	0.0	0.0	0.0	0.0		0.0	0.0		0.0	0.0	0.0
Detector 1 Queue (s)	0.0	0.0	0.0	0.0	0.0		0.0	0.0		0.0	0.0	0.0
Detector 1 Delay (s)	0.0	0.0	0.0	0.0	0.0		0.0	0.0		0.0	0.0	0.0
Detector 2 Position(m)					9.4			9.4			9.4	
Detector 2 Size(m)					0.6			0.6			0.6	
Detector 2 Type					Cl+Ex			Cl+Ex			Cl+Ex	
Detector 2 Channel												
Detector 2 Extend (s)					0.0			0.0			0.0	

Perthmore Subdivision TIS  
26: Wilson Street & Sunset Boulevard

Existing Conditions 2020  
PM Peak Hour



Lane Group	EBL	EBT	EBR	WBL	WBT	WBR	NBL	NBT	NBR	SBL	SBT	SBR
Turn Type	Perm	NA	Perm	Perm	NA		pm+pt	NA		pm+pt	NA	Perm
Protected Phases		4			8		5	2		1	6	
Permitted Phases	4		4	8			2			6		6
Detector Phase	4	4	4	8	8		5	2		1	6	6
Switch Phase							2			6		
Minimum Initial (s)	10.0	10.0	10.0	10.0	10.0		5.0	10.0		5.0	10.0	10.0
Minimum Split (s)	22.6	22.6	22.6	22.6	22.6		9.6	22.6		9.6	22.6	22.6
Total Split (s)	22.6	22.6	22.6	22.6	22.6		9.6	27.8		9.6	27.8	27.8
Total Split (%)	37.7%	37.7%	37.7%	37.7%	37.7%		16.0%	46.3%		16.0%	46.3%	46.3%
Maximum Green (s)	18.0	18.0	18.0	18.0	18.0		5.0	23.2		5.0	23.2	23.2
Yellow Time (s)	3.3	3.3	3.3	3.3	3.3		3.3	3.3		3.3	3.3	3.3
All-Red Time (s)	1.3	1.3	1.3	1.3	1.3		1.3	1.3		1.3	1.3	1.3
Lost Time Adjust (s)		0.0	0.0		0.0		0.0	0.0		0.0	0.0	0.0
Total Lost Time (s)		4.6	4.6		4.6		4.6	4.6		4.6	4.6	4.6
Lead/Lag							Lead	Lag		Lead	Lag	Lag
Lead-Lag Optimize?							Yes	Yes		Yes	Yes	Yes
Vehicle Extension (s)	3.0	3.0	3.0	3.0	3.0		3.0	3.0		3.0	3.0	3.0
Recall Mode	None	None	None	None	None		None	Min		None	Min	Min
Walk Time (s)	7.0	7.0	7.0	7.0	7.0			7.0			7.0	7.0
Flash Dont Walk (s)	11.0	11.0	11.0	11.0	11.0			11.0			11.0	11.0
Pedestrian Calls (#/hr)	0	0	0	0	0			0			0	0
Act Effct Green (s)		12.2	12.2		12.2		31.1	30.2		28.4	24.5	24.5
Actuated g/C Ratio		0.23	0.23		0.23		0.58	0.57		0.53	0.46	0.46
v/c Ratio		0.48	0.40		0.23		0.29	0.59		0.03	0.78	0.09
Control Delay		23.6	5.8		13.6		7.5	13.7		5.6	23.2	1.3
Queue Delay		0.0	0.0		0.0		0.0	0.0		0.0	0.0	0.0
Total Delay		23.6	5.8		13.6		7.5	13.7		5.6	23.2	1.3
LOS		C	A		B		A	B		A	C	A
Approach Delay		13.4			13.6			12.9			21.0	
Approach LOS		B			B			B			C	

Intersection Summary

Area Type: Other  
 Cycle Length: 60  
 Actuated Cycle Length: 53.4  
 Natural Cycle: 60  
 Control Type: Semi Act-Uncoord  
 Maximum v/c Ratio: 0.78  
 Intersection Signal Delay: 16.2  
 Intersection LOS: B  
 Intersection Capacity Utilization 65.8%  
 ICU Level of Service C  
 Analysis Period (min) 15

Splits and Phases: 26: Wilson Street & Sunset Boulevard

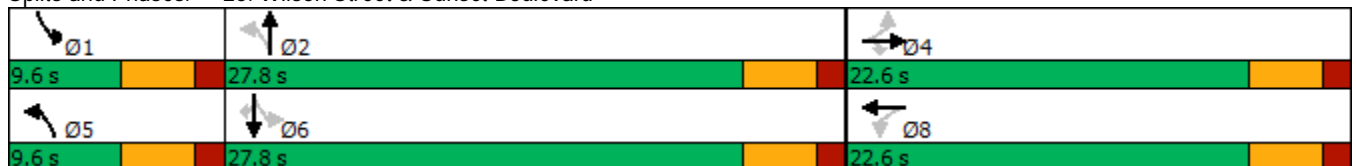



Perthmore Subdivision TIS  
30: Wilson Street & Leslie Street/Isabella Street

Existing Conditions 2020  
PM Peak Hour



Lane Group	EBL	EBT	EBR	WBL	WBT	WBR	NBL	NBT	NBR	SBL	SBT	SBR
Lane Configurations		↕			↕		↗	↘		↗	↘	
Traffic Volume (vph)	101	21	5	26	24	62	2	496	3	32	572	40
Future Volume (vph)	101	21	5	26	24	62	2	496	3	32	572	40
Ideal Flow (vphpl)	1900	1900	1900	1900	1900	1900	1900	1900	1900	1900	1900	1900
Storage Length (m)	0.0		0.0	0.0		0.0	60.0		0.0	25.0		0.0
Storage Lanes	0		0	0		0	1		0	1		0
Taper Length (m)	7.5			7.5			25.0			15.0		
Lane Util. Factor	1.00	1.00	1.00	1.00	1.00	1.00	1.00	1.00	1.00	1.00	1.00	1.00
Ped Bike Factor		0.99			0.98		0.99	1.00		1.00	1.00	
Frt		0.994			0.925			0.999			0.990	
Flt Protected		0.962			0.989		0.950			0.950		
Satd. Flow (prot)	0	1771	0	0	1711	0	1805	1843	0	1703	1822	0
Flt Permitted		0.769			0.913		0.212			0.344		
Satd. Flow (perm)	0	1408	0	0	1572	0	399	1843	0	614	1822	0
Right Turn on Red			Yes			Yes			Yes			Yes
Satd. Flow (RTOR)		3			69			1			9	
Link Speed (k/h)		50			50			50			50	
Link Distance (m)		224.9			415.9			340.1			341.7	
Travel Time (s)		16.2			29.9			24.5			24.6	
Confl. Peds. (#/hr)	3		10	10		3	28		7	7		28
Peak Hour Factor	0.76	0.76	0.76	0.90	0.90	0.90	0.96	0.96	0.96	0.85	0.85	0.85
Heavy Vehicles (%)	3%	0%	0%	0%	0%	0%	0%	3%	0%	6%	3%	0%
Adj. Flow (vph)	133	28	7	29	27	69	2	517	3	38	673	47
Shared Lane Traffic (%)												
Lane Group Flow (vph)	0	168	0	0	125	0	2	520	0	38	720	0
Enter Blocked Intersection	No	No	No	No	No	No	No	No	No	No	No	No
Lane Alignment	Left	Left	Right	Left	Left	Right	Left	Left	Right	Left	Left	Right
Median Width(m)		0.0			0.0			3.6			3.6	
Link Offset(m)		0.0			0.0			0.0			0.0	
Crosswalk Width(m)		4.8			4.8			4.8			4.8	
Two way Left Turn Lane												
Headway Factor	1.00	1.00	1.00	1.00	1.00	1.00	1.00	1.00	1.00	1.00	1.00	1.00
Turning Speed (k/h)	25		15	25		15	25		15	25		15
Number of Detectors	1	2		1	2		1	2		1	2	
Detector Template	Left	Thru		Left	Thru		Left	Thru		Left	Thru	
Leading Detector (m)	2.0	10.0		2.0	10.0		2.0	10.0		2.0	10.0	
Trailing Detector (m)	0.0	0.0		0.0	0.0		0.0	0.0		0.0	0.0	
Detector 1 Position(m)	0.0	0.0		0.0	0.0		0.0	0.0		0.0	0.0	
Detector 1 Size(m)	2.0	0.6		2.0	0.6		2.0	0.6		2.0	0.6	
Detector 1 Type	Cl+Ex	Cl+Ex		Cl+Ex	Cl+Ex		Cl+Ex	Cl+Ex		Cl+Ex	Cl+Ex	
Detector 1 Channel												
Detector 1 Extend (s)	0.0	0.0		0.0	0.0		0.0	0.0		0.0	0.0	
Detector 1 Queue (s)	0.0	0.0		0.0	0.0		0.0	0.0		0.0	0.0	
Detector 1 Delay (s)	0.0	0.0		0.0	0.0		0.0	0.0		0.0	0.0	
Detector 2 Position(m)		9.4			9.4			9.4			9.4	
Detector 2 Size(m)		0.6			0.6			0.6			0.6	
Detector 2 Type		Cl+Ex			Cl+Ex			Cl+Ex			Cl+Ex	
Detector 2 Channel												
Detector 2 Extend (s)		0.0			0.0			0.0			0.0	

Perthmore Subdivision TIS  
30: Wilson Street & Leslie Street/Isabella Street

Existing Conditions 2020  
PM Peak Hour



Lane Group	EBL	EBT	EBR	WBL	WBT	WBR	NBL	NBT	NBR	SBL	SBT	SBR
Turn Type	Perm	NA		Perm	NA		pm+pt	NA		pm+pt	NA	
Protected Phases		4			8		5	2		1	6	
Permitted Phases	4			8			2			6		
Detector Phase	4	4		8	8		5	2		1	6	
Switch Phase							2			6		
Minimum Initial (s)	10.0	10.0		10.0	10.0		5.0	10.0		5.0	10.0	
Minimum Split (s)	15.0	15.0		15.0	15.0		9.6	35.0		9.6	35.0	
Total Split (s)	15.0	15.0		15.0	15.0		9.6	35.4		9.6	35.4	
Total Split (%)	25.0%	25.0%		25.0%	25.0%		16.0%	59.0%		16.0%	59.0%	
Maximum Green (s)	10.4	10.4		10.4	10.4		5.0	30.8		5.0	30.8	
Yellow Time (s)	3.3	3.3		3.3	3.3		3.3	3.3		3.3	3.3	
All-Red Time (s)	1.3	1.3		1.3	1.3		1.3	1.3		1.3	1.3	
Lost Time Adjust (s)		0.0			0.0		0.0	0.0		0.0	0.0	
Total Lost Time (s)		4.6			4.6		4.6	4.6		4.6	4.6	
Lead/Lag							Lead	Lag		Lead	Lag	
Lead-Lag Optimize?							Yes	Yes		Yes	Yes	
Vehicle Extension (s)	3.0	3.0		3.0	3.0		3.0	3.0		3.0	3.0	
Recall Mode	None	None		None	None		None	Min		None	Min	
Walk Time (s)	5.0	5.0		5.0	5.0			7.0			7.0	
Flash Dont Walk (s)	5.0	5.0		5.0	5.0			11.0			11.0	
Pedestrian Calls (#/hr)	0	0		0	0			0			0	
Act Effct Green (s)		10.5			10.5		25.3	23.6		26.2	25.4	
Actuated g/C Ratio		0.22			0.22		0.54	0.50		0.56	0.54	
v/c Ratio		0.53			0.31		0.01	0.56		0.08	0.73	
Control Delay		26.6			12.4		3.5	11.8		4.3	14.3	
Queue Delay		0.0			0.0		0.0	0.0		0.0	0.0	
Total Delay		26.6			12.4		3.5	11.8		4.3	14.3	
LOS		C			B		A	B		A	B	
Approach Delay		26.6			12.4			11.8			13.8	
Approach LOS		C			B			B			B	

Intersection Summary

Area Type: Other  
 Cycle Length: 60  
 Actuated Cycle Length: 46.9  
 Natural Cycle: 60  
 Control Type: Semi Act-Uncoord  
 Maximum v/c Ratio: 0.73  
 Intersection Signal Delay: 14.4  
 Intersection LOS: B  
 Intersection Capacity Utilization 54.1%  
 ICU Level of Service A  
 Analysis Period (min) 15

Splits and Phases: 30: Wilson Street & Leslie Street/Isabella Street

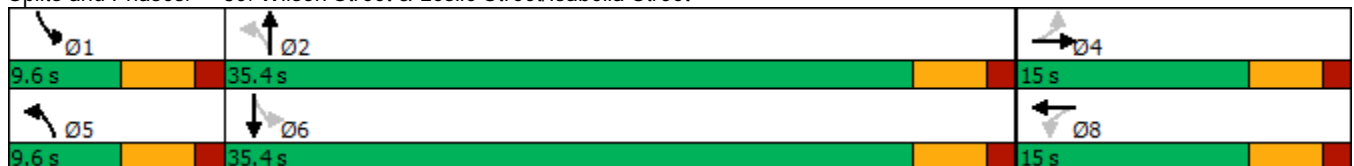

HCM 6th TWSC  
 3: Drummond Concession 2 & Perthmore

Existing Conditions 2020

Intersection						
Int Delay, s/veh	1.3					
Movement	EBL	EBT	WBT	WBR	SBL	SBR
Lane Configurations		↕	↑	↗	↘	
Traffic Vol, veh/h	20	181	133	16	4	23
Future Vol, veh/h	20	181	133	16	4	23
Conflicting Peds, #/hr	0	0	0	0	0	0
Sign Control	Free	Free	Free	Free	Stop	Stop
RT Channelized	-	None	-	None	-	None
Storage Length	-	-	-	250	0	-
Veh in Median Storage, #	-	0	0	-	0	-
Grade, %	-	0	0	-	0	-
Peak Hour Factor	85	85	83	83	68	68
Heavy Vehicles, %	20	2	0	0	25	0
Mvmt Flow	24	213	160	19	6	34

Major/Minor	Major1	Major2	Minor2		
Conflicting Flow All	179	0	0	421	160
Stage 1	-	-	-	160	-
Stage 2	-	-	-	261	-
Critical Hdwy	4.3	-	-	6.65	6.2
Critical Hdwy Stg 1	-	-	-	5.65	-
Critical Hdwy Stg 2	-	-	-	5.65	-
Follow-up Hdwy	2.38	-	-	3.725	3.3
Pot Cap-1 Maneuver	1295	-	-	548	890
Stage 1	-	-	-	816	-
Stage 2	-	-	-	732	-
Platoon blocked, %	-	-	-	-	-
Mov Cap-1 Maneuver	1295	-	-	536	890
Mov Cap-2 Maneuver	-	-	-	536	-
Stage 1	-	-	-	799	-
Stage 2	-	-	-	732	-

Approach	EB	WB	SB
HCM Control Delay, s	0.8	0	9.7
HCM LOS			A

Minor Lane/Major Mvmt	EBL	EBT	WBT	WBR	SBLn1
Capacity (veh/h)	1295	-	-	-	811
HCM Lane V/C Ratio	0.018	-	-	-	0.049
HCM Control Delay (s)	7.8	0	-	-	9.7
HCM Lane LOS	A	A	-	-	A
HCM 95th %tile Q(veh)	0.1	-	-	-	0.2

**Intersection**

Int Delay, s/veh 1.6

Movement	EBT	EBR	WBL	WBT	NBL	NBR
Lane Configurations						
Traffic Vol, veh/h	59	10	14	70	8	10
Future Vol, veh/h	59	10	14	70	8	10
Conflicting Peds, #/hr	0	0	0	0	1	7
Sign Control	Free	Free	Free	Free	Stop	Stop
RT Channelized	-	None	-	None	-	None
Storage Length	-	-	-	-	0	-
Veh in Median Storage, #	0	-	-	0	0	-
Grade, %	0	-	-	0	0	-
Peak Hour Factor	78	78	72	72	75	75
Heavy Vehicles, %	2	0	0	1	0	10
Mvmt Flow	76	13	19	97	11	13

**Major/Minor**

	Major1	Major2	Minor1		
Conflicting Flow All	0	0	89	0	219
Stage 1	-	-	-	-	83
Stage 2	-	-	-	-	136
Critical Hdwy	-	-	4.1	-	6.4
Critical Hdwy Stg 1	-	-	-	-	5.4
Critical Hdwy Stg 2	-	-	-	-	5.4
Follow-up Hdwy	-	-	2.2	-	3.5
Pot Cap-1 Maneuver	-	-	1519	-	774
Stage 1	-	-	-	-	945
Stage 2	-	-	-	-	895
Platoon blocked, %	-	-	-	-	-
Mov Cap-1 Maneuver	-	-	1519	-	763
Mov Cap-2 Maneuver	-	-	-	-	763
Stage 1	-	-	-	-	945
Stage 2	-	-	-	-	882

**Approach**

	EB	WB	NB
HCM Control Delay, s	0	1.2	9.3
HCM LOS			A

**Minor Lane/Major Mvmt**

	NBLn1	EBT	EBR	WBL	WBT
Capacity (veh/h)	852	-	-	1519	-
HCM Lane V/C Ratio	0.028	-	-	0.013	-
HCM Control Delay (s)	9.3	-	-	7.4	0
HCM Lane LOS	A	-	-	A	A
HCM 95th %tile Q(veh)	0.1	-	-	0	-

HCM 6th TWSC  
 34: Wilson Street & North Street

Existing Conditions 2020

Intersection												
Int Delay, s/veh	3.5											
Movement	EBL	EBT	EBR	WBL	WBT	WBR	NBL	NBT	NBR	SBL	SBT	SBR
Lane Configurations		↕			↕			↕			↕	
Traffic Vol, veh/h	5	4	10	9	8	100	9	386	21	112	454	23
Future Vol, veh/h	5	4	10	9	8	100	9	386	21	112	454	23
Conflicting Peds, #/hr	4	0	7	7	0	4	16	0	15	15	0	16
Sign Control	Stop	Stop	Stop	Stop	Stop	Stop	Free	Free	Free	Free	Free	Free
RT Channelized	-	-	None	-	-	None	-	-	None	-	-	None
Storage Length	-	-	-	-	-	-	-	-	-	-	-	650
Veh in Median Storage, #	-	0	-	-	0	-	-	0	-	-	0	-
Grade, %	-	0	-	-	0	-	-	0	-	-	0	-
Peak Hour Factor	68	68	68	94	94	94	89	89	89	96	96	96
Heavy Vehicles, %	20	0	0	0	0	7	0	1	0	12	1	0
Mvmt Flow	7	6	15	10	9	106	10	434	24	117	473	24

Major/Minor	Minor2		Minor1		Major1			Major2				
Conflicting Flow All	1263	1228	272	962	1228	465	513	0	0	473	0	0
Stage 1	735	735	-	481	481	-	-	-	-	-	-	-
Stage 2	528	493	-	481	747	-	-	-	-	-	-	-
Critical Hdwy	7.6	6.5	6.9	7.3	6.5	6.305	4.1	-	-	4.28	-	-
Critical Hdwy Stg 1	6.8	5.5	-	6.1	5.5	-	-	-	-	-	-	-
Critical Hdwy Stg 2	6.4	5.5	-	6.5	5.5	-	-	-	-	-	-	-
Follow-up Hdwy	3.69	4	3.3	3.5	4.3	3.665	2.2	-	-	2.314	-	-
Pot Cap-1 Maneuver	121	180	732	225	180	584	1063	-	-	1028	-	-
Stage 1	346	428	-	570	557	-	-	-	-	-	-	-
Stage 2	494	550	-	540	423	-	-	-	-	-	-	-
Platoon blocked, %								-	-	-	-	-
Mov Cap-1 Maneuver	81	145	718	182	145	575	1049	-	-	1015	-	-
Mov Cap-2 Maneuver	81	145	-	182	145	-	-	-	-	-	-	-
Stage 1	337	354	-	555	543	-	-	-	-	-	-	-
Stage 2	390	536	-	434	350	-	-	-	-	-	-	-

Approach	EB		WB		NB		SB	
HCM Control Delay, s	28		17.1		0.2		2.1	
HCM LOS	D		C					

Minor Lane/Major Mvmt	NBL	NBT	NBR	EBLn1	WBLn1	SBL	SBT	SBR
Capacity (veh/h)	1049	-	-	184	420	1015	-	-
HCM Lane V/C Ratio	0.01	-	-	0.152	0.296	0.115	-	-
HCM Control Delay (s)	8.5	0	-	28	17.1	9	0.5	-
HCM Lane LOS	A	A	-	D	C	A	A	-
HCM 95th %tile Q(veh)	0	-	-	0.5	1.2	0.4	-	-

HCM 6th AWSC  
7: Drummond Street & North Street

Existing Conditions 2020

Intersection	
Intersection Delay, s/veh	16.5
Intersection LOS	C

Movement	EBL	EBT	EBR	WBL	WBT	WBR	NBL	NBT	NBR	SBL	SBT	SBR
Lane Configurations		↕			↕			↕			↕	
Traffic Vol, veh/h	11	74	12	40	76	108	15	251	33	116	228	11
Future Vol, veh/h	11	74	12	40	76	108	15	251	33	116	228	11
Peak Hour Factor	0.85	0.85	0.85	0.85	0.85	0.85	0.89	0.89	0.89	0.85	0.85	0.85
Heavy Vehicles, %	0	6	0	0	5	1	0	0	0	0	0	0
Mvmt Flow	13	87	14	47	89	127	17	282	37	136	268	13
Number of Lanes	0	1	0	0	1	0	0	1	0	0	1	0

Approach	EB	WB	NB	SB
Opposing Approach	WB	EB	SB	NB
Opposing Lanes	1	1	1	1
Conflicting Approach Left	SB	NB	EB	WB
Conflicting Lanes Left	1	1	1	1
Conflicting Approach Right	NB	SB	WB	EB
Conflicting Lanes Right	1	1	1	1
HCM Control Delay	11.6	14	15.8	20.1
HCM LOS	B	B	C	C

Lane	NBLn1	EBLn1	WBLn1	SBLn1
Vol Left, %	5%	11%	18%	33%
Vol Thru, %	84%	76%	34%	64%
Vol Right, %	11%	12%	48%	3%
Sign Control	Stop	Stop	Stop	Stop
Traffic Vol by Lane	299	97	224	355
LT Vol	15	11	40	116
Through Vol	251	74	76	228
RT Vol	33	12	108	11
Lane Flow Rate	336	114	264	418
Geometry Grp	1	1	1	1
Degree of Util (X)	0.548	0.212	0.446	0.675
Departure Headway (Hd)	5.869	6.693	6.096	5.821
Convergence, Y/N	Yes	Yes	Yes	Yes
Cap	618	534	590	622
Service Time	3.884	4.756	4.147	3.835
HCM Lane V/C Ratio	0.544	0.213	0.447	0.672
HCM Control Delay	15.8	11.6	14	20.1
HCM Lane LOS	C	B	B	C
HCM 95th-tile Q	3.3	0.8	2.3	5.2

Perthmore Subdivision TIS  
 12: Wilson Street /Canadian tire Ent/Ext & HWY 7

Background 2030  
 AM Peak Hour



Lane Group	EBL	EBT	EBR	WBL	WBT	WBR	NBL	NBT	NBR	SBL	SBT	SBR
Lane Configurations		↕↕			↕↕			↕	↗		↕	↗
Traffic Volume (vph)	70	486	276	221	609	13	339	70	227	49	69	108
Future Volume (vph)	70	486	276	221	609	13	339	70	227	49	69	108
Ideal Flow (vphpl)	1900	1900	1900	1900	1900	1900	1900	1900	1900	1900	1900	1900
Storage Length (m)	0.0		0.0	0.0		0.0	0.0		60.0	30.0		0.0
Storage Lanes	0		0	0		0	0		1	1		1
Taper Length (m)	7.5			7.5			7.5			10.0		
Lane Util. Factor	0.95	0.95	0.95	0.95	0.95	0.95	1.00	1.00	1.00	1.00	1.00	1.00
Ped Bike Factor									0.99		1.00	
Frt		0.950			0.998				0.850			0.850
Flt Protected		0.996			0.987			0.960			0.980	
Satd. Flow (prot)	0	3314	0	0	3406	0	0	1765	1509	0	1782	1583
Flt Permitted		0.750			0.515			0.628			0.698	
Satd. Flow (perm)	0	2495	0	0	1777	0	0	1155	1490	0	1269	1583
Right Turn on Red			Yes			Yes			Yes			Yes
Satd. Flow (RTOR)		80			2				241			117
Link Speed (k/h)		60			60			50			50	
Link Distance (m)		455.2			323.0			662.7			562.7	
Travel Time (s)		27.3			19.4			47.7			40.5	
Confl. Peds. (#/hr)									1	1		
Peak Hour Factor	0.91	0.91	0.91	0.96	0.96	0.96	0.94	0.94	0.94	0.92	0.92	0.92
Heavy Vehicles (%)	0%	3%	4%	0%	6%	5%	4%	0%	7%	8%	2%	2%
Adj. Flow (vph)	77	534	303	230	634	14	361	74	241	53	75	117
Shared Lane Traffic (%)												
Lane Group Flow (vph)	0	914	0	0	878	0	0	435	241	0	128	117
Enter Blocked Intersection	No	No	No	No	No	No	No	No	No	No	No	No
Lane Alignment	Left	Left	Right	Left	Left	Right	Left	Left	Right	Left	Left	Right
Median Width(m)		0.0			0.0			3.6			3.6	
Link Offset(m)		0.0			0.0			0.0			0.0	
Crosswalk Width(m)		4.8			4.8			4.8			4.8	
Two way Left Turn Lane												
Headway Factor	1.00	1.00	1.00	1.00	1.00	1.00	1.00	1.00	1.00	1.00	1.00	1.00
Turning Speed (k/h)	25		15	25		15	25		15	25		15
Number of Detectors	1	2		1	2		1	1	1	1	1	1
Detector Template	Left			Left			Left			Left		
Leading Detector (m)	2.0	98.8		2.0	91.8		2.0	9.0	9.0	2.0	9.0	9.0
Trailing Detector (m)	0.0	-3.0		0.0	-3.0		0.0	-3.0	-3.0	0.0	-0.2	-3.0
Detector 1 Position(m)	0.0	-3.0		0.0	-3.0		0.0	-3.0	-3.0	0.0	-0.2	-3.0
Detector 1 Size(m)	2.0	12.0		2.0	12.0		2.0	12.0	12.0	2.0	9.2	12.0
Detector 1 Type	Cl+Ex	Cl+Ex		Cl+Ex	Cl+Ex		Cl+Ex	Cl+Ex	Cl+Ex	Cl+Ex	Cl+Ex	Cl+Ex
Detector 1 Channel												
Detector 1 Extend (s)	0.0	0.0		0.0	0.0		0.0	0.0	0.0	0.0	0.0	0.0
Detector 1 Queue (s)	0.0	0.0		0.0	0.0		0.0	0.0	0.0	0.0	0.0	0.0
Detector 1 Delay (s)	0.0	0.0		0.0	0.0		0.0	0.0	0.0	0.0	0.0	0.0
Detector 2 Position(m)		97.0			90.0							
Detector 2 Size(m)		1.8			1.8							
Detector 2 Type		Cl+Ex			Cl+Ex							
Detector 2 Channel												
Detector 2 Extend (s)		0.0			0.0							



Perthmore Subdivision TIS  
 12: Wilson Street /Canadian tire Ent/Ext & HWY 7

Background 2030  
 AM Peak Hour



Lane Group	EBL	EBT	EBR	WBL	WBT	WBR	NBL	NBT	NBR	SBL	SBT	SBR
Turn Type	Perm	NA		pm+pt	NA		pm+pt	NA	Perm	Perm	NA	Perm
Protected Phases		2		1	6		3	8			4	
Permitted Phases	2			6			8		8	4		4
Detector Phase	2	2		1	1 6		3	3 8	8	4	4	4
Switch Phase												
Minimum Initial (s)	20.0	20.0		7.0	20.0		7.0	10.0	10.0	10.0	10.0	10.0
Minimum Split (s)	43.9	43.9		9.0	43.9		9.0	37.4	37.4	37.4	37.4	37.4
Total Split (s)	43.9	43.9		16.0	59.9		16.0	53.4	53.4	37.4	37.4	37.4
Total Split (%)	38.7%	38.7%		14.1%	52.9%		14.1%	47.1%	47.1%	33.0%	33.0%	33.0%
Maximum Green (s)	37.0	37.0		14.0	53.0		14.0	47.0	47.0	31.0	31.0	31.0
Yellow Time (s)	5.0	5.0		2.0	5.0		2.0	4.1	4.1	4.1	4.1	4.1
All-Red Time (s)	1.9	1.9		0.0	1.9		0.0	2.3	2.3	2.3	2.3	2.3
Lost Time Adjust (s)		0.0			0.0			0.0	0.0		0.0	0.0
Total Lost Time (s)		6.9			6.9			6.4	6.4		6.4	6.4
Lead/Lag	Lag	Lag		Lead			Lead			Lag	Lag	Lag
Lead-Lag Optimize?	Yes	Yes		Yes			Yes			Yes	Yes	Yes
Vehicle Extension (s)	4.5	4.5		2.0	4.5		2.0	3.0	3.0	3.0	3.0	3.0
Recall Mode	Max	Max		None	Max		None	None	None	None	None	None
Walk Time (s)	7.0	7.0			7.0			7.0	7.0	7.0	7.0	7.0
Flash Dont Walk (s)	30.0	30.0			30.0			24.0	24.0	24.0	24.0	24.0
Pedestrian Calls (#/hr)	0	0			0			1	1	0	0	0
Act Effct Green (s)		37.1			53.2			41.7	41.7		25.7	25.7
Actuated g/C Ratio		0.34			0.49			0.39	0.39		0.24	0.24
v/c Ratio		1.01			0.87			0.87	0.33		0.43	0.25
Control Delay		65.4			33.8			48.3	4.0		39.1	7.3
Queue Delay		0.0			0.0			0.0	0.0		0.0	0.0
Total Delay		65.4			33.8			48.3	4.0		39.1	7.3
LOS		E			C			D	A		D	A
Approach Delay		65.4			33.8			32.5			23.9	
Approach LOS		E			C			C			C	

Intersection Summary

Area Type: Other  
 Cycle Length: 113.3  
 Actuated Cycle Length: 108.3  
 Natural Cycle: 110  
 Control Type: Semi Act-Uncoord  
 Maximum v/c Ratio: 1.01  
 Intersection Signal Delay: 43.2  
 Intersection LOS: D  
 Intersection Capacity Utilization 93.9%  
 ICU Level of Service F  
 Analysis Period (min) 15

Splits and Phases: 12: Wilson Street /Canadian tire Ent/Ext & HWY 7

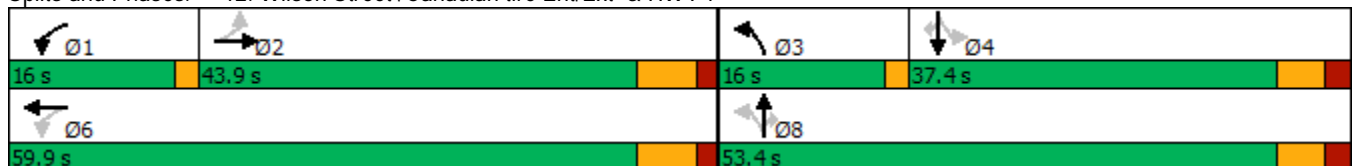

Perthmore Subdivision TIS  
 15: Drummond Street/Dufferin Street & HWY 7

Background 2030  
 AM Peak Hour



Lane Group	EBL	EBT	EBR	WBL	WBT	WBR	NBL	NBT	NBR	SBL	SBT	SBR
Lane Configurations		↕↕			↕↕	↗	↗	↗	↗	↗	↗	↗
Traffic Volume (vph)	87	374	216	122	524	20	262	60	125	17	58	100
Future Volume (vph)	87	374	216	122	524	20	262	60	125	17	58	100
Ideal Flow (vphpl)	1900	1900	1900	1900	1900	1900	1900	1900	1900	1900	1900	1900
Storage Length (m)	0.0		0.0	0.0		15.0	65.0		0.0	40.0		0.0
Storage Lanes	0		0	0		1	1		0	1		0
Taper Length (m)	7.5			7.5			0.0			20.0		
Lane Util. Factor	0.95	0.95	0.95	0.95	0.95	1.00	1.00	1.00	1.00	1.00	1.00	1.00
Ped Bike Factor								0.99		1.00		
Frt		0.952				0.850		0.899				0.905
Flt Protected		0.994			0.991		0.950			0.950		
Satd. Flow (prot)	0	3253	0	0	3317	1429	1770	1660	0	1671	1678	0
Flt Permitted		0.737			0.586		0.608			0.596		
Satd. Flow (perm)	0	2412	0	0	1961	1429	1133	1660	0	1048	1678	0
Right Turn on Red			Yes			Yes			Yes			Yes
Satd. Flow (RTOR)		96				37		115				95
Link Speed (k/h)		60			60			50				50
Link Distance (m)		323.0			140.6			376.3				291.5
Travel Time (s)		19.4			8.4			27.1				21.0
Confl. Peds. (#/hr)									1	1		
Peak Hour Factor	0.91	0.91	0.91	0.90	0.90	0.90	0.87	0.87	0.87	0.77	0.77	0.77
Heavy Vehicles (%)	4%	7%	2%	3%	9%	13%	2%	2%	2%	8%	5%	1%
Adj. Flow (vph)	96	411	237	136	582	22	301	69	144	22	75	130
Shared Lane Traffic (%)												
Lane Group Flow (vph)	0	744	0	0	718	22	301	213	0	22	205	0
Enter Blocked Intersection	No	No	No	No	No	No	No	No	No	No	No	No
Lane Alignment	Left	Left	Right	Left	Left	Right	Left	Left	Right	Left	Left	Right
Median Width(m)		0.0			0.0			3.6			3.6	
Link Offset(m)		0.0			0.0			0.0			0.0	
Crosswalk Width(m)		4.8			4.8			4.8			4.8	
Two way Left Turn Lane												
Headway Factor	1.00	1.00	1.00	1.00	1.00	1.00	1.00	1.00	1.00	1.00	1.00	1.00
Turning Speed (k/h)	25		15	25		15	25		15	25		15
Number of Detectors	1	1		1	2	0	1	1		1	1	
Detector Template	Left			Left		Right						
Leading Detector (m)	2.0	94.8		2.0	86.8	0.0	9.0	9.0		9.0	9.0	
Trailing Detector (m)	0.0	93.0		0.0	-1.0	0.0	-3.0	-3.0		-3.0	-3.0	
Detector 1 Position(m)	0.0	93.0		0.0	-1.0	0.0	-3.0	-3.0		-3.0	-3.0	
Detector 1 Size(m)	2.0	1.8		2.0	12.0	2.0	12.0	12.0		12.0	12.0	
Detector 1 Type	Cl+Ex	Cl+Ex		Cl+Ex	Cl+Ex	Cl+Ex	Cl+Ex	Cl+Ex		Cl+Ex	Cl+Ex	
Detector 1 Channel												
Detector 1 Extend (s)	0.0	0.0		0.0	0.0	0.0	0.0	0.0		0.0	0.0	
Detector 1 Queue (s)	0.0	0.0		0.0	0.0	0.0	0.0	0.0		0.0	0.0	
Detector 1 Delay (s)	0.0	0.0		0.0	0.0	0.0	0.0	0.0		0.0	0.0	
Detector 2 Position(m)					85.0							
Detector 2 Size(m)					1.8							
Detector 2 Type					Cl+Ex							
Detector 2 Channel												
Detector 2 Extend (s)					0.0							

Perthmore Subdivision TIS  
 15: Drummond Street/Dufferin Street & HWY 7

Background 2030  
 AM Peak Hour



Lane Group	EBL	EBT	EBR	WBL	WBT	WBR	NBL	NBT	NBR	SBL	SBT	SBR
Turn Type	Perm	NA		pm+pt	NA	Perm	Perm	NA		Perm	NA	
Protected Phases		2		1	6			8			4	
Permitted Phases	2			6		6	8			4		
Detector Phase	2	2		1	1 6	6	8	8		4	4	
Switch Phase												
Minimum Initial (s)	20.0	20.0		7.0	20.0	20.0	10.0	10.0		10.0	10.0	
Minimum Split (s)	33.3	33.3		10.0	36.3	36.3	38.3	38.3		38.3	38.3	
Total Split (s)	46.3	46.3		13.0	59.3	59.3	38.3	38.3		38.3	38.3	
Total Split (%)	47.4%	47.4%		13.3%	60.8%	60.8%	39.2%	39.2%		39.2%	39.2%	
Maximum Green (s)	40.0	40.0		10.0	53.0	53.0	32.0	32.0		32.0	32.0	
Yellow Time (s)	5.0	5.0		3.0	5.0	5.0	4.1	4.1		4.1	4.1	
All-Red Time (s)	1.3	1.3		0.0	1.3	1.3	2.2	2.2		2.2	2.2	
Lost Time Adjust (s)		0.0			0.0	0.0	0.0	0.0		0.0	0.0	
Total Lost Time (s)		6.3			6.3	6.3	6.3	6.3		6.3	6.3	
Lead/Lag	Lag	Lag		Lead								
Lead-Lag Optimize?	Yes	Yes		Yes								
Vehicle Extension (s)	4.6	4.6		3.0	4.6	4.6	3.0	3.0		3.0	3.0	
Recall Mode	Min	Min		None	Min	Min	None	None		None	None	
Walk Time (s)	7.0	7.0			7.0	7.0	7.0	7.0		7.0	7.0	
Flash Dont Walk (s)	20.0	20.0			20.0	20.0	25.0	25.0		25.0	25.0	
Pedestrian Calls (#/hr)	0	0			0	0	1	1		0	0	
Act Effct Green (s)		30.1			43.5	43.5	27.0	27.0		27.0	27.0	
Actuated g/C Ratio		0.36			0.52	0.52	0.32	0.32		0.32	0.32	
v/c Ratio		0.80			0.63	0.03	0.82	0.35		0.07	0.34	
Control Delay		28.3			16.3	1.9	47.4	12.8		22.5	14.2	
Queue Delay		0.0			0.0	0.0	0.0	0.0		0.0	0.0	
Total Delay		28.3			16.3	1.9	47.4	12.8		22.5	14.2	
LOS		C			B	A	D	B		C	B	
Approach Delay		28.3			15.9			33.1			15.0	
Approach LOS		C			B			C			B	

Intersection Summary

Area Type: Other  
 Cycle Length: 97.6  
 Actuated Cycle Length: 83.5  
 Natural Cycle: 85  
 Control Type: Semi Act-Uncoord  
 Maximum v/c Ratio: 0.82  
 Intersection Signal Delay: 23.9  
 Intersection Capacity Utilization 82.5%  
 Analysis Period (min) 15  
 Intersection LOS: C  
 ICU Level of Service E

Splits and Phases: 15: Drummond Street/Dufferin Street & HWY 7

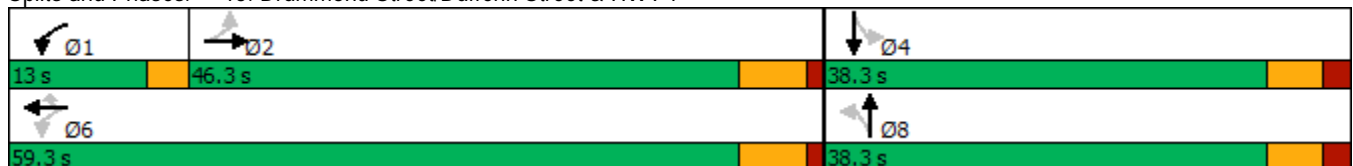

Perthmore Subdivision TIS  
26: Wilson Street & Sunset Boulevard

Background 2030  
AM Peak Hour



Lane Group	EBL	EBT	EBR	WBL	WBT	WBR	NBL	NBT	NBR	SBL	SBT	SBR
Lane Configurations		↕	↗		↕		↗	↖		↖	↕	↗
Traffic Volume (vph)	95	15	179	12	47	19	115	392	0	5	462	59
Future Volume (vph)	95	15	179	12	47	19	115	392	0	5	462	59
Ideal Flow (vphpl)	1900	1900	1900	1900	1900	1900	1900	1900	1900	1900	1900	1900
Storage Length (m)	0.0		0.0	0.0		0.0	15.0		0.0	25.0		0.0
Storage Lanes	0		1	0		0	1		0	1		1
Taper Length (m)	7.5			7.5			7.5			7.5		
Lane Util. Factor	1.00	1.00	1.00	1.00	1.00	1.00	1.00	1.00	1.00	1.00	1.00	1.00
Ped Bike Factor		0.97	0.97		0.98		0.99			1.00		0.94
Frt			0.850		0.967							0.850
Flt Protected		0.959			0.992		0.950			0.950		
Satd. Flow (prot)	0	1704	1524	0	1762	0	1787	1792	0	1805	1810	1583
Flt Permitted		0.747			0.936		0.241			0.444		
Satd. Flow (perm)	0	1285	1483	0	1661	0	447	1792	0	841	1810	1484
Right Turn on Red			Yes			Yes			Yes			Yes
Satd. Flow (RTOR)			314		28							113
Link Speed (k/h)		50			50			50				50
Link Distance (m)		357.7			280.8			341.7				662.7
Travel Time (s)		25.8			20.2			24.6				47.7
Confl. Peds. (#/hr)	27		4	4		27	26		5	5		26
Peak Hour Factor	0.55	0.55	0.55	0.64	0.64	0.64	0.85	0.85	0.85	0.86	0.86	0.86
Heavy Vehicles (%)	8%	0%	6%	0%	3%	0%	1%	6%	0%	0%	5%	2%
Adj. Flow (vph)	173	27	325	19	73	30	135	461	0	6	537	69
Shared Lane Traffic (%)												
Lane Group Flow (vph)	0	200	325	0	122	0	135	461	0	6	537	69
Enter Blocked Intersection	No	No	No	No	No	No	No	No	No	No	No	No
Lane Alignment	Left	Left	Right	Left	Left	Right	Left	Left	Right	Left	Left	Right
Median Width(m)		0.0			0.0			3.6				3.6
Link Offset(m)		0.0			0.0			0.0				0.0
Crosswalk Width(m)		4.8			4.8			4.8				4.8
Two way Left Turn Lane												
Headway Factor	1.00	1.00	1.00	1.00	1.00	1.00	1.00	1.00	1.00	1.00	1.00	1.00
Turning Speed (k/h)	25		15	25		15	25		15	25		15
Number of Detectors	1	2	1	1	2		1	2		1	2	1
Detector Template	Left		Right	Left	Thru			Thru			Thru	Right
Leading Detector (m)	2.0	10.0	2.0	2.0	10.0		4.0	10.0		4.0	10.0	2.0
Trailing Detector (m)	0.0	5.0	0.0	0.0	0.0		-1.0	0.0		-1.0	0.0	0.0
Detector 1 Position(m)	0.0	5.0	0.0	0.0	0.0		-1.0	0.0		-1.0	0.0	0.0
Detector 1 Size(m)	2.0	5.0	2.0	2.0	0.6		5.0	0.6		5.0	0.6	2.0
Detector 1 Type	Cl+Ex	Cl+Ex	Cl+Ex	Cl+Ex	Cl+Ex		Cl+Ex	Cl+Ex		Cl+Ex	Cl+Ex	Cl+Ex
Detector 1 Channel												
Detector 1 Extend (s)	0.0	0.0	0.0	0.0	0.0		0.0	0.0		0.0	0.0	0.0
Detector 1 Queue (s)	0.0	0.0	0.0	0.0	0.0		0.0	0.0		0.0	0.0	0.0
Detector 1 Delay (s)	0.0	0.0	0.0	0.0	0.0		0.0	0.0		0.0	0.0	0.0
Detector 2 Position(m)		9.4			9.4			9.4				9.4
Detector 2 Size(m)		0.6			0.6			0.6				0.6
Detector 2 Type		Cl+Ex			Cl+Ex			Cl+Ex				Cl+Ex
Detector 2 Channel												
Detector 2 Extend (s)		0.0			0.0			0.0				0.0

Perthmore Subdivision TIS  
26: Wilson Street & Sunset Boulevard

Background 2030  
AM Peak Hour



Lane Group	EBL	EBT	EBR	WBL	WBT	WBR	NBL	NBT	NBR	SBL	SBT	SBR
Turn Type	Perm	NA	Perm	Perm	NA		pm+pt	NA		pm+pt	NA	Perm
Protected Phases		4			8		5	2		1	6	
Permitted Phases	4		4	8			2			6		6
Detector Phase	4	4	4	8	8		5	2		1	6	6
Switch Phase							2			6		
Minimum Initial (s)	10.0	10.0	10.0	10.0	10.0		5.0	10.0		5.0	10.0	10.0
Minimum Split (s)	22.6	22.6	22.6	22.6	22.6		9.6	22.6		9.6	22.6	22.6
Total Split (s)	22.6	22.6	22.6	22.6	22.6		9.6	27.8		9.6	27.8	27.8
Total Split (%)	37.7%	37.7%	37.7%	37.7%	37.7%		16.0%	46.3%		16.0%	46.3%	46.3%
Maximum Green (s)	18.0	18.0	18.0	18.0	18.0		5.0	23.2		5.0	23.2	23.2
Yellow Time (s)	3.3	3.3	3.3	3.3	3.3		3.3	3.3		3.3	3.3	3.3
All-Red Time (s)	1.3	1.3	1.3	1.3	1.3		1.3	1.3		1.3	1.3	1.3
Lost Time Adjust (s)		0.0	0.0		0.0		0.0	0.0		0.0	0.0	0.0
Total Lost Time (s)		4.6	4.6		4.6		4.6	4.6		4.6	4.6	4.6
Lead/Lag							Lead	Lag		Lead	Lag	Lag
Lead-Lag Optimize?							Yes	Yes		Yes	Yes	Yes
Vehicle Extension (s)	3.0	3.0	3.0	3.0	3.0		3.0	3.0		3.0	3.0	3.0
Recall Mode	None	None	None	None	None		None	Min		None	Min	Min
Walk Time (s)	7.0	7.0	7.0	7.0	7.0			7.0			7.0	7.0
Flash Dont Walk (s)	11.0	11.0	11.0	11.0	11.0			11.0			11.0	11.0
Pedestrian Calls (#/hr)	5	5	5	20	20			20			4	4
Act Effct Green (s)		13.9	13.9		13.9		25.1	24.2		22.4	18.8	18.8
Actuated g/C Ratio		0.28	0.28		0.28		0.51	0.49		0.45	0.38	0.38
v/c Ratio		0.56	0.51		0.25		0.36	0.53		0.01	0.78	0.11
Control Delay		24.2	5.9		14.4		9.1	12.5		6.2	24.7	1.6
Queue Delay		0.0	0.0		0.0		0.0	0.0		0.0	0.0	0.0
Total Delay		24.2	5.9		14.4		9.1	12.5		6.2	24.7	1.6
LOS		C	A		B		A	B		A	C	A
Approach Delay		12.9			14.4			11.7			21.9	
Approach LOS		B			B			B			C	

Intersection Summary

Area Type: Other  
 Cycle Length: 60  
 Actuated Cycle Length: 49.5  
 Natural Cycle: 60  
 Control Type: Semi Act-Uncoord  
 Maximum v/c Ratio: 0.78  
 Intersection Signal Delay: 15.6  
 Intersection LOS: B  
 Intersection Capacity Utilization 60.1%  
 ICU Level of Service B  
 Analysis Period (min) 15

Splits and Phases: 26: Wilson Street & Sunset Boulevard

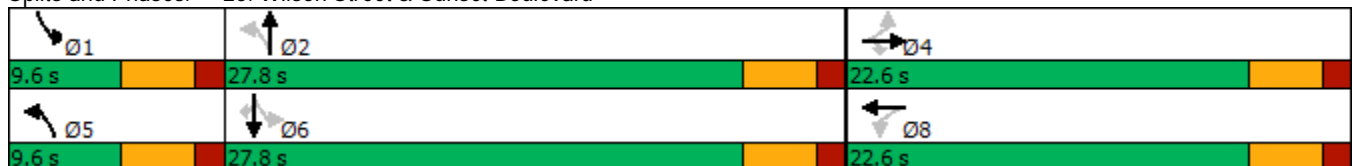

Perthmore Subdivision TIS  
30: Wilson Street & Leslie Street/Isabella Street

Background 2030  
AM Peak Hour



Lane Group	EBL	EBT	EBR	WBL	WBT	WBR	NBL	NBT	NBR	SBL	SBT	SBR
Lane Configurations		↕			↕		↗	↘		↗	↘	
Traffic Volume (vph)	27	10	3	18	9	58	0	411	3	44	513	28
Future Volume (vph)	27	10	3	18	9	58	0	411	3	44	513	28
Ideal Flow (vphpl)	1900	1900	1900	1900	1900	1900	1900	1900	1900	1900	1900	1900
Storage Length (m)	0.0		0.0	0.0		0.0	60.0		0.0	25.0		0.0
Storage Lanes	0		0	0		0	1		0	1		0
Taper Length (m)	7.5			7.5			25.0			15.0		
Lane Util. Factor	1.00	1.00	1.00	1.00	1.00	1.00	1.00	1.00	1.00	1.00	1.00	1.00
Ped Bike Factor		0.97			0.95			1.00		0.99	1.00	
Frt		0.990			0.908			0.999			0.992	
Flt Protected		0.967			0.990					0.950		
Satd. Flow (prot)	0	1512	0	0	1554	0	1900	1758	0	1752	1745	0
Flt Permitted		0.821			0.918					0.328		
Satd. Flow (perm)	0	1246	0	0	1437	0	1900	1758	0	599	1745	0
Right Turn on Red			Yes			Yes			Yes			Yes
Satd. Flow (RTOR)		4			81			1			7	
Link Speed (k/h)		50			50			50			50	
Link Distance (m)		227.0			415.9			340.1			341.7	
Travel Time (s)		16.3			29.9			24.5			24.6	
Confl. Peds. (#/hr)	20		4	4		20	5		14	14		5
Peak Hour Factor	0.78	0.78	0.78	0.72	0.72	0.72	0.82	0.82	0.82	0.82	0.82	0.82
Heavy Vehicles (%)	24%	0%	50%	0%	14%	4%	0%	8%	0%	3%	7%	23%
Adj. Flow (vph)	35	13	4	25	13	81	0	501	4	54	626	34
Shared Lane Traffic (%)												
Lane Group Flow (vph)	0	52	0	0	119	0	0	505	0	54	660	0
Enter Blocked Intersection	No	No	No	No	No	No	No	No	No	No	No	No
Lane Alignment	Left	Left	Right	Left	Left	Right	Left	Left	Right	Left	Left	Right
Median Width(m)		0.0			0.0			3.6			3.6	
Link Offset(m)		0.0			0.0			0.0			0.0	
Crosswalk Width(m)		4.8			4.8			4.8			4.8	
Two way Left Turn Lane												
Headway Factor	1.00	1.00	1.00	1.00	1.00	1.00	1.00	1.00	1.00	1.00	1.00	1.00
Turning Speed (k/h)	25		15	25		15	25		15	25		15
Number of Detectors	1	1		1	1		1	1		1	1	
Detector Template	Left			Left			Left			Left		
Leading Detector (m)	2.0	0.6		2.0	0.6		2.0	0.6		2.0	0.6	
Trailing Detector (m)	0.0	0.0		0.0	0.0		0.0	0.0		0.0	0.0	
Detector 1 Position(m)	0.0	0.0		0.0	0.0		0.0	0.0		0.0	0.0	
Detector 1 Size(m)	2.0	0.6		2.0	0.6		2.0	0.6		2.0	0.6	
Detector 1 Type	Cl+Ex	Cl+Ex		Cl+Ex	Cl+Ex		Cl+Ex	Cl+Ex		Cl+Ex	Cl+Ex	
Detector 1 Channel												
Detector 1 Extend (s)	0.0	0.0		0.0	0.0		0.0	0.0		0.0	0.0	
Detector 1 Queue (s)	0.0	0.0		0.0	0.0		0.0	0.0		0.0	0.0	
Detector 1 Delay (s)	0.0	0.0		0.0	0.0		0.0	0.0		0.0	0.0	
Turn Type	Perm	NA		Perm	NA		pm+pt	NA		pm+pt	NA	
Protected Phases		4			8		5	2		1	6	
Permitted Phases	4			8			2			6		
Detector Phase	4	4		8	8		5	2		1	6	
Switch Phase							2			1		

Perthmore Subdivision TIS  
 30: Wilson Street & Leslie Street/Isabella Street

Background 2030  
 AM Peak Hour



Lane Group	EBL	EBT	EBR	WBL	WBT	WBR	NBL	NBT	NBR	SBL	SBT	SBR
Minimum Initial (s)	10.0	10.0		10.0	10.0		5.0	10.0		5.0	10.0	
Minimum Split (s)	15.1	15.1		15.1	15.1		9.6	35.0		9.6	35.0	
Total Split (s)	15.1	15.1		15.1	15.1		9.6	35.3		9.6	35.3	
Total Split (%)	25.2%	25.2%		25.2%	25.2%		16.0%	58.8%		16.0%	58.8%	
Maximum Green (s)	10.5	10.5		10.5	10.5		5.0	30.7		5.0	30.7	
Yellow Time (s)	3.3	3.3		3.3	3.3		3.3	3.3		3.3	3.3	
All-Red Time (s)	1.3	1.3		1.3	1.3		1.3	1.3		1.3	1.3	
Lost Time Adjust (s)		0.0			0.0		0.0	0.0		0.0	0.0	
Total Lost Time (s)		4.6			4.6		4.6	4.6		4.6	4.6	
Lead/Lag							Lead	Lag		Lead	Lag	
Lead-Lag Optimize?							Yes	Yes		Yes	Yes	
Vehicle Extension (s)	3.0	3.0		3.0	3.0		3.0	3.0		3.0	3.0	
Recall Mode	None	None		None	None		None	Min		None	Min	
Walk Time (s)	6.0	6.0		6.0	6.0			7.0			7.0	
Flash Dont Walk (s)	4.5	4.5		4.5	4.5			11.0			11.0	
Pedestrian Calls (#/hr)	14	14		5	5			18			4	
Act Effect Green (s)		10.6			10.6			25.5		27.3	28.6	
Actuated g/C Ratio		0.24			0.24			0.59		0.63	0.66	
v/c Ratio		0.17			0.29			0.49		0.10	0.57	
Control Delay		17.8			10.5			10.8		4.4	8.2	
Queue Delay		0.0			0.0			0.0		0.0	0.0	
Total Delay		17.8			10.5			10.8		4.4	8.2	
LOS		B			B			B		A	A	
Approach Delay		17.8			10.5			10.8			7.9	
Approach LOS		B			B			B			A	

Intersection Summary

Area Type:	Other
Cycle Length:	60
Actuated Cycle Length:	43.3
Natural Cycle:	60
Control Type:	Semi Act-Uncoord
Maximum v/c Ratio:	0.57
Intersection Signal Delay:	9.6
Intersection LOS:	A
Intersection Capacity Utilization	52.8%
ICU Level of Service	A
Analysis Period (min)	15

Splits and Phases: 30: Wilson Street & Leslie Street/Isabella Street

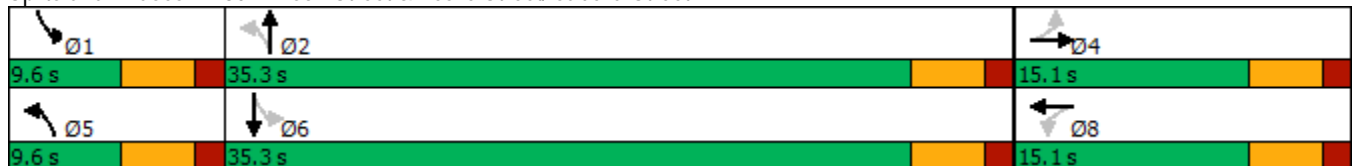



HCM 6th AWSC  
7: Drummond Street & North Street

Buildout Year 2030

Intersection	
Intersection Delay, s/veh	21.3
Intersection LOS	C

Movement	EBL	EBT	EBR	WBL	WBT	WBR	NBL	NBT	NBR	SBL	SBT	SBR
Lane Configurations		↕			↕			↕			↕	
Traffic Vol, veh/h	12	93	12	52	92	97	4	221	37	105	250	18
Future Vol, veh/h	12	93	12	52	92	97	4	221	37	105	250	18
Peak Hour Factor	0.67	0.67	0.67	0.88	0.88	0.88	0.90	0.90	0.90	0.78	0.78	0.78
Heavy Vehicles, %	0	16	0	0	14	0	0	2	3	1	3	7
Mvmt Flow	18	139	18	59	105	110	4	246	41	135	321	23
Number of Lanes	0	1	0	0	1	0	0	1	0	0	1	0

Approach	EB	WB	NB	SB
Opposing Approach	WB	EB	SB	NB
Opposing Lanes	1	1	1	1
Conflicting Approach Left	SB	NB	EB	WB
Conflicting Lanes Left	1	1	1	1
Conflicting Approach Right	NB	SB	WB	EB
Conflicting Lanes Right	1	1	1	1
HCM Control Delay	13.7	16	16.1	30.4
HCM LOS	B	C	C	D

Lane	NBLn1	EBLn1	WBLn1	SBLn1
Vol Left, %	2%	10%	22%	28%
Vol Thru, %	84%	79%	38%	67%
Vol Right, %	14%	10%	40%	5%
Sign Control	Stop	Stop	Stop	Stop
Traffic Vol by Lane	262	117	241	373
LT Vol	4	12	52	105
Through Vol	221	93	92	250
RT Vol	37	12	97	18
Lane Flow Rate	291	175	274	478
Geometry Grp	1	1	1	1
Degree of Util (X)	0.515	0.339	0.498	0.811
Departure Headway (Hd)	6.364	6.98	6.541	6.102
Convergence, Y/N	Yes	Yes	Yes	Yes
Cap	562	512	548	593
Service Time	4.443	5.07	4.621	4.17
HCM Lane V/C Ratio	0.518	0.342	0.5	0.806
HCM Control Delay	16.1	13.7	16	30.4
HCM Lane LOS	C	B	C	D
HCM 95th-tile Q	2.9	1.5	2.8	8.1

HCM 6th TWSC  
3: Drummond Concession 2 & Perthmore

Buildout Year 2030

Intersection						
Int Delay, s/veh	1.3					
Movement	EBL	EBT	WBT	WBR	SBL	SBR
Lane Configurations		↕	↑	↗	↘	
Traffic Vol, veh/h	16	127	194	5	10	22
Future Vol, veh/h	16	127	194	5	10	22
Conflicting Peds, #/hr	0	0	0	0	0	0
Sign Control	Free	Free	Free	Free	Stop	Stop
RT Channelized	-	None	-	None	-	None
Storage Length	-	-	-	250	0	-
Veh in Median Storage, #	-	0	0	-	0	-
Grade, %	-	0	0	-	0	-
Peak Hour Factor	83	83	84	84	78	78
Heavy Vehicles, %	50	9	1	25	0	12
Mvmt Flow	19	153	231	6	13	28

Major/Minor	Major1	Major2	Minor2		
Conflicting Flow All	237	0	0	422	231
Stage 1	-	-	-	231	-
Stage 2	-	-	-	191	-
Critical Hdwy	4.6	-	-	6.4	6.32
Critical Hdwy Stg 1	-	-	-	5.4	-
Critical Hdwy Stg 2	-	-	-	5.4	-
Follow-up Hdwy	2.65	-	-	3.5	3.408
Pot Cap-1 Maneuver	1094	-	-	592	784
Stage 1	-	-	-	812	-
Stage 2	-	-	-	846	-
Platoon blocked, %	-	-	-	-	-
Mov Cap-1 Maneuver	1094	-	-	581	784
Mov Cap-2 Maneuver	-	-	-	581	-
Stage 1	-	-	-	797	-
Stage 2	-	-	-	846	-

Approach	EB	WB	SB
HCM Control Delay, s	0.9	0	10.4
HCM LOS			B

Minor Lane/Major Mvmt	EBL	EBT	WBT	WBR	SBLn1
Capacity (veh/h)	1094	-	-	-	707
HCM Lane V/C Ratio	0.018	-	-	-	0.058
HCM Control Delay (s)	8.3	0	-	-	10.4
HCM Lane LOS	A	A	-	-	B
HCM 95th %tile Q(veh)	0.1	-	-	-	0.2

Intersection						
Int Delay, s/veh	5.4					
Movement	EBT	EBR	WBL	WBT	NBL	NBR
Lane Configurations						
Traffic Vol, veh/h	61	91	15	47	78	17
Future Vol, veh/h	61	91	15	47	78	17
Conflicting Peds, #/hr	0	0	0	0	0	24
Sign Control	Free	Free	Free	Free	Stop	Stop
RT Channelized	-	None	-	None	-	None
Storage Length	-	-	-	-	0	-
Veh in Median Storage, #	0	-	-	0	0	-
Grade, %	0	-	-	0	0	-
Peak Hour Factor	63	63	68	68	41	41
Heavy Vehicles, %	2	25	17	8	3	15
Mvmt Flow	97	144	22	69	190	41

Major/Minor	Major1	Major2	Minor1		
Conflicting Flow All	0	0	241	0	282
Stage 1	-	-	-	-	169
Stage 2	-	-	-	-	113
Critical Hdwy	-	-	4.27	-	6.43
Critical Hdwy Stg 1	-	-	-	-	5.43
Critical Hdwy Stg 2	-	-	-	-	5.43
Follow-up Hdwy	-	-	2.353	-	3.527
Pot Cap-1 Maneuver	-	-	1242	-	706
Stage 1	-	-	-	-	858
Stage 2	-	-	-	-	909
Platoon blocked, %	-	-	-	-	-
Mov Cap-1 Maneuver	-	-	1242	-	693
Mov Cap-2 Maneuver	-	-	-	-	693
Stage 1	-	-	-	-	858
Stage 2	-	-	-	-	893

Approach	EB	WB	NB
HCM Control Delay, s	0	1.9	12.5
HCM LOS			B

Minor Lane/Major Mvmt	NBLn1	EBT	EBR	WBL	WBT
Capacity (veh/h)	710	-	-	1242	-
HCM Lane V/C Ratio	0.326	-	-	0.018	-
HCM Control Delay (s)	12.5	-	-	8	0
HCM Lane LOS	B	-	-	A	A
HCM 95th %tile Q(veh)	1.4	-	-	0.1	-

HCM 6th TWSC  
34: Wilson Street & North Street

Buildout Year 2030

Intersection												
Int Delay, s/veh	3.1											
Movement	EBL	EBT	EBR	WBL	WBT	WBR	NBL	NBT	NBR	SBL	SBT	SBR
Lane Configurations		↕			↕			↕			↕	
Traffic Vol, veh/h	6	5	10	6	4	73	6	362	10	81	440	20
Future Vol, veh/h	6	5	10	6	4	73	6	362	10	81	440	20
Conflicting Peds, #/hr	3	0	3	3	0	3	12	0	9	9	0	12
Sign Control	Stop	Stop	Stop	Stop	Stop	Stop	Free	Free	Free	Free	Free	Free
RT Channelized	-	-	None	-	-	None	-	-	None	-	-	None
Storage Length	-	-	-	-	-	-	-	-	-	-	-	650
Veh in Median Storage, #	-	0	-	-	0	-	-	0	-	-	0	-
Grade, %	-	0	-	-	0	-	-	0	-	-	0	-
Peak Hour Factor	71	71	71	77	77	77	89	89	89	79	79	79
Heavy Vehicles, %	20	0	0	0	0	28	0	6	0	29	2	25
Mvmt Flow	8	7	14	8	5	95	7	407	11	103	557	25

Major/Minor	Minor2		Minor1		Major1			Major2				
Conflicting Flow All	1268	1229	306	927	1236	425	594	0	0	427	0	0
Stage 1	788	788	-	436	436	-	-	-	-	-	-	-
Stage 2	480	441	-	491	800	-	-	-	-	-	-	-
Critical Hdwy	7.6	6.5	6.9	7.3	6.5	6.62	4.1	-	-	4.535	-	-
Critical Hdwy Stg 1	6.8	5.5	-	6.1	5.5	-	-	-	-	-	-	-
Critical Hdwy Stg 2	6.4	5.5	-	6.5	5.5	-	-	-	-	-	-	-
Follow-up Hdwy	3.69	4	3.3	3.5	4	3.566	2.2	-	-	2.4755	-	-
Pot Cap-1 Maneuver	120	179	696	238	178	566	992	-	-	980	-	-
Stage 1	321	405	-	603	583	-	-	-	-	-	-	-
Stage 2	526	580	-	533	400	-	-	-	-	-	-	-
Platoon blocked, %								-	-	-	-	-
Mov Cap-1 Maneuver	84	147	687	194	146	560	982	-	-	973	-	-
Mov Cap-2 Maneuver	84	147	-	194	146	-	-	-	-	-	-	-
Stage 1	315	338	-	593	573	-	-	-	-	-	-	-
Stage 2	428	570	-	430	334	-	-	-	-	-	-	-

Approach	EB		WB		NB		SB	
HCM Control Delay, s	29.7		15.8		0.1		1.8	
HCM LOS	D		C					

Minor Lane/Major Mvmt	NBL	NBT	NBR	EBLn1WBLn1	SBL	SBT	SBR
Capacity (veh/h)	982	-	-	175	440	973	-
HCM Lane V/C Ratio	0.007	-	-	0.169	0.245	0.105	-
HCM Control Delay (s)	8.7	0	-	29.7	15.8	9.1	0.5
HCM Lane LOS	A	A	-	D	C	A	A
HCM 95th %tile Q(veh)	0	-	-	0.6	1	0.4	-

Perthmore Subdivision TIS  
 12: Wilson Street /Canadian tire Ent/Ext & HWY 7

Background 2030  
 PM Peak Hour



Lane Group	EBL	EBT	EBR	WBL	WBT	WBR	NBL	NBT	NBR	SBL	SBT	SBR
Lane Configurations		↕↕			↕↕			↕	↗		↕	↗
Traffic Volume (vph)	55	737	123	119	681	9	196	28	191	61	26	102
Future Volume (vph)	55	737	123	119	681	9	196	28	191	61	26	102
Ideal Flow (vphpl)	1900	1900	1900	1900	1900	1900	1900	1900	1900	1900	1900	1900
Storage Length (m)	0.0		0.0	0.0		0.0	0.0		60.0	30.0		0.0
Storage Lanes	0		0	0		0	0		1	1		1
Taper Length (m)	7.5			7.5			7.5			10.0		
Lane Util. Factor	0.95	0.95	0.95	0.95	0.95	0.95	1.00	1.00	1.00	1.00	1.00	1.00
Ped Bike Factor								1.00				0.98
Frt		0.980			0.998				0.850			0.850
Flt Protected		0.997			0.993			0.958			0.966	
Satd. Flow (prot)	0	3399	0	0	3419	0	0	1759	1509	0	1835	1615
Flt Permitted		0.794			0.504			0.616			0.607	
Satd. Flow (perm)	0	2707	0	0	1735	0	0	1128	1509	0	1153	1590
Right Turn on Red			Yes			Yes			Yes			Yes
Satd. Flow (RTOR)		16			1				273			110
Link Speed (k/h)		60			60			50			50	
Link Distance (m)		455.2			323.0			477.5			562.7	
Travel Time (s)		27.3			19.4			34.4			40.5	
Confl. Peds. (#/hr)							3					3
Peak Hour Factor	0.82	0.82	0.82	0.87	0.87	0.87	0.70	0.70	0.70	0.93	0.93	0.93
Heavy Vehicles (%)	0%	4%	4%	3%	5%	0%	4%	0%	7%	0%	0%	0%
Adj. Flow (vph)	67	899	150	137	783	10	280	40	273	66	28	110
Shared Lane Traffic (%)												
Lane Group Flow (vph)	0	1116	0	0	930	0	0	320	273	0	94	110
Enter Blocked Intersection	No	No	No	No	No	No	No	No	No	No	No	No
Lane Alignment	Left	Left	Right	Left	Left	Right	Left	Left	Right	Left	Left	Right
Median Width(m)		0.0			0.0			0.0			0.0	
Link Offset(m)		0.0			0.0			0.0			0.0	
Crosswalk Width(m)		4.8			4.8			4.8			4.8	
Two way Left Turn Lane												
Headway Factor	1.00	1.00	1.00	1.00	1.00	1.00	1.00	1.00	1.00	1.00	1.00	1.00
Turning Speed (k/h)	25		15	25		15	25		15	25		15
Number of Detectors	1	2		1	2		1	1	1	1	1	1
Detector Template	Left			Left			Left			Left		
Leading Detector (m)	2.0	98.8		2.0	91.8		2.0	9.0	9.0	2.0	9.0	9.0
Trailing Detector (m)	0.0	-3.0		0.0	-3.0		0.0	-3.0	-3.0	0.0	-0.2	-3.0
Detector 1 Position(m)	0.0	-3.0		0.0	-3.0		0.0	-3.0	-3.0	0.0	-0.2	-3.0
Detector 1 Size(m)	2.0	12.0		2.0	12.0		2.0	12.0	12.0	2.0	9.2	12.0
Detector 1 Type	Cl+Ex	Cl+Ex		Cl+Ex	Cl+Ex		Cl+Ex	Cl+Ex	Cl+Ex	Cl+Ex	Cl+Ex	Cl+Ex
Detector 1 Channel												
Detector 1 Extend (s)	0.0	0.0		0.0	0.0		0.0	0.0	0.0	0.0	0.0	0.0
Detector 1 Queue (s)	0.0	0.0		0.0	0.0		0.0	0.0	0.0	0.0	0.0	0.0
Detector 1 Delay (s)	0.0	0.0		0.0	0.0		0.0	0.0	0.0	0.0	0.0	0.0
Detector 2 Position(m)		97.0			90.0							
Detector 2 Size(m)		1.8			1.8							
Detector 2 Type		Cl+Ex			Cl+Ex							
Detector 2 Channel												
Detector 2 Extend (s)		0.0			0.0							

Perthmore Subdivision TIS  
 12: Wilson Street /Canadian tire Ent/Ext & HWY 7

Background 2030  
 PM Peak Hour



Lane Group	EBL	EBT	EBR	WBL	WBT	WBR	NBL	NBT	NBR	SBL	SBT	SBR
Turn Type	Perm	NA		pm+pt	NA		pm+pt	NA	Perm	Perm	NA	Perm
Protected Phases		2		1	6		3	8			4	
Permitted Phases	2			6			8		8	4		4
Detector Phase	2	2		1	1 6		3	3 8	8	4	4	4
Switch Phase												
Minimum Initial (s)	20.0	20.0		7.0	20.0		7.0	10.0	10.0	10.0	10.0	10.0
Minimum Split (s)	43.9	43.9		9.0	43.9		9.0	37.4	37.4	37.4	37.4	37.4
Total Split (s)	43.9	43.9		16.0	59.9		16.0	53.4	53.4	37.4	37.4	37.4
Total Split (%)	38.7%	38.7%		14.1%	52.9%		14.1%	47.1%	47.1%	33.0%	33.0%	33.0%
Maximum Green (s)	37.0	37.0		14.0	53.0		14.0	47.0	47.0	31.0	31.0	31.0
Yellow Time (s)	5.0	5.0		2.0	5.0		2.0	4.1	4.1	4.1	4.1	4.1
All-Red Time (s)	1.9	1.9		0.0	1.9		0.0	2.3	2.3	2.3	2.3	2.3
Lost Time Adjust (s)		0.0			0.0			0.0	0.0		0.0	0.0
Total Lost Time (s)		6.9			6.9			6.4	6.4		6.4	6.4
Lead/Lag	Lag	Lag		Lead			Lead			Lag	Lag	Lag
Lead-Lag Optimize?	Yes	Yes		Yes			Yes			Yes	Yes	Yes
Vehicle Extension (s)	4.5	4.5		2.0	4.5		2.0	3.0	3.0	3.0	3.0	3.0
Recall Mode	Min	Min		None	Min		None	None	None	None	None	None
Walk Time (s)	7.0	7.0			7.0			7.0	7.0	7.0	7.0	7.0
Flash Dont Walk (s)	30.0	30.0			30.0			24.0	24.0	24.0	24.0	24.0
Pedestrian Calls (#/hr)	0	0			0			3	3	0	0	0
Act Effct Green (s)		37.2			53.3			33.2	33.2		17.3	17.3
Actuated g/C Ratio		0.37			0.53			0.33	0.33		0.17	0.17
v/c Ratio		1.10			0.86			0.74	0.40		0.47	0.30
Control Delay		89.4			28.9			38.5	4.5		44.1	8.5
Queue Delay		0.0			0.0			0.0	0.0		0.0	0.0
Total Delay		89.4			28.9			38.5	4.5		44.1	8.5
LOS		F			C			D	A		D	A
Approach Delay		89.4			28.9			22.8			24.9	
Approach LOS		F			C			C			C	

Intersection Summary

Area Type: Other  
 Cycle Length: 113.3  
 Actuated Cycle Length: 99.9  
 Natural Cycle: 130  
 Control Type: Semi Act-Uncoord  
 Maximum v/c Ratio: 1.10  
 Intersection Signal Delay: 51.1  
 Intersection LOS: D  
 Intersection Capacity Utilization 84.3%  
 ICU Level of Service E  
 Analysis Period (min) 15

Splits and Phases: 12: Wilson Street /Canadian tire Ent/Ext & HWY 7

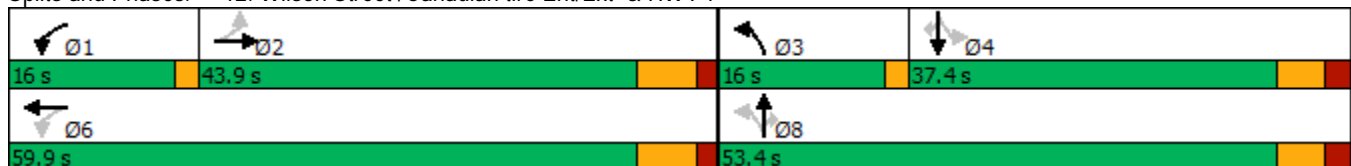

Perthmore Subdivision TIS  
 15: Drummond Street/Dufferin Street & HWY 7

Background 2030  
 PM Peak Hour



Lane Group	EBL	EBT	EBR	WBL	WBT	WBR	NBL	NBT	NBR	SBL	SBT	SBR
Lane Configurations		↕↕			↕↕	↗	↖	↗	↖	↖	↗	↗
Traffic Volume (vph)	69	539	348	137	495	5	259	20	122	14	24	69
Future Volume (vph)	69	539	348	137	495	5	259	20	122	14	24	69
Ideal Flow (vphpl)	1900	1900	1900	1900	1900	1900	1900	1900	1900	1900	1900	1900
Storage Length (m)	0.0		0.0	0.0		15.0	65.0		0.0	40.0		0.0
Storage Lanes	0		0	0		1	1		0	1		0
Taper Length (m)	7.5			7.5			0.0			20.0		
Lane Util. Factor	0.95	0.95	0.95	0.95	0.95	1.00	1.00	1.00	1.00	1.00	1.00	1.00
Ped Bike Factor							1.00	0.99		1.00	0.99	
Frt		0.945				0.850		0.871			0.888	
Flt Protected		0.996			0.989		0.950			0.950		
Satd. Flow (prot)	0	3264	0	0	3436	1615	1787	1606	0	1805	1647	0
Flt Permitted		0.825			0.511		0.679			0.654		
Satd. Flow (perm)	0	2704	0	0	1775	1615	1276	1606	0	1240	1647	0
Right Turn on Red			Yes			Yes			Yes			Yes
Satd. Flow (RTOR)		148				37		139			90	
Link Speed (k/h)		60			60			50			50	
Link Distance (m)		323.0			172.1			376.3			222.4	
Travel Time (s)		19.4			10.3			27.1			16.0	
Confl. Peds. (#/hr)							1		3	3		1
Peak Hour Factor	0.81	0.81	0.81	0.94	0.94	0.94	0.88	0.88	0.88	0.77	0.77	0.77
Heavy Vehicles (%)	2%	7%	0%	0%	5%	0%	1%	0%	2%	0%	0%	2%
Adj. Flow (vph)	85	665	430	146	527	5	294	23	139	18	31	90
Shared Lane Traffic (%)												
Lane Group Flow (vph)	0	1180	0	0	673	5	294	162	0	18	121	0
Enter Blocked Intersection	No	No	No	No	No	No	No	No	No	No	No	No
Lane Alignment	Left	Left	Right	Left	Left	Right	Left	Left	Right	Left	Left	Right
Median Width(m)		0.0			0.0			3.6			3.6	
Link Offset(m)		0.0			0.0			0.0			0.0	
Crosswalk Width(m)		4.8			4.8			4.8			4.8	
Two way Left Turn Lane												
Headway Factor	1.00	1.00	1.00	1.00	1.00	1.00	1.00	1.00	1.00	1.00	1.00	1.00
Turning Speed (k/h)	25		15	25		15	25		15	25		15
Number of Detectors	1	1		1	2	0	1	1		1	1	
Detector Template	Left			Left		Right						
Leading Detector (m)	2.0	94.8		2.0	86.8	0.0	9.0	9.0		9.0	9.0	
Trailing Detector (m)	0.0	93.0		0.0	-1.0	0.0	-3.0	-3.0		-3.0	-3.0	
Detector 1 Position(m)	0.0	93.0		0.0	-1.0	0.0	-3.0	-3.0		-3.0	-3.0	
Detector 1 Size(m)	2.0	1.8		2.0	12.0	2.0	12.0	12.0		12.0	12.0	
Detector 1 Type	Cl+Ex	Cl+Ex		Cl+Ex	Cl+Ex	Cl+Ex	Cl+Ex	Cl+Ex		Cl+Ex	Cl+Ex	
Detector 1 Channel												
Detector 1 Extend (s)	0.0	0.0		0.0	0.0	0.0	0.0	0.0		0.0	0.0	
Detector 1 Queue (s)	0.0	0.0		0.0	0.0	0.0	0.0	0.0		0.0	0.0	
Detector 1 Delay (s)	0.0	0.0		0.0	0.0	0.0	0.0	0.0		0.0	0.0	
Detector 2 Position(m)					85.0							
Detector 2 Size(m)					1.8							
Detector 2 Type					Cl+Ex							
Detector 2 Channel												
Detector 2 Extend (s)					0.0							



Perthmore Subdivision TIS  
 15: Drummond Street/Dufferin Street & HWY 7

Background 2030  
 PM Peak Hour



Lane Group	EBL	EBT	EBR	WBL	WBT	WBR	NBL	NBT	NBR	SBL	SBT	SBR
Turn Type	Perm	NA		pm+pt	NA	Perm	Perm	NA		Perm	NA	
Protected Phases		2		1	6			8				4
Permitted Phases	2			6		6	8			4		
Detector Phase	2	2		1	1 6	6	8	8		4		4
Switch Phase												
Minimum Initial (s)	20.0	20.0		7.0	20.0	20.0	10.0	10.0		10.0		10.0
Minimum Split (s)	33.3	33.3		10.0	36.3	36.3	38.3	38.3		38.3		38.3
Total Split (s)	46.3	46.3		10.0	59.3	59.3	38.3	38.3		38.3		38.3
Total Split (%)	47.4%	47.4%		10.2%	60.8%	60.8%	39.2%	39.2%		39.2%		39.2%
Maximum Green (s)	40.0	40.0		7.0	53.0	53.0	32.0	32.0		32.0		32.0
Yellow Time (s)	5.0	5.0		3.0	5.0	5.0	4.1	4.1		4.1		4.1
All-Red Time (s)	1.3	1.3		0.0	1.3	1.3	2.2	2.2		2.2		2.2
Lost Time Adjust (s)		0.0			0.0	0.0	0.0	0.0		0.0		0.0
Total Lost Time (s)		6.3			6.3	6.3	6.3	6.3		6.3		6.3
Lead/Lag	Lag	Lag		Lead								
Lead-Lag Optimize?	Yes	Yes		Yes								
Vehicle Extension (s)	4.6	4.6		3.0	4.6	4.6	3.0	3.0		3.0		3.0
Recall Mode	Min	Min		None	Min	Min	None	None		None		None
Walk Time (s)	7.0	7.0			7.0	7.0	7.0	7.0		7.0		7.0
Flash Dont Walk (s)	20.0	20.0			20.0	20.0	25.0	25.0		25.0		25.0
Pedestrian Calls (#/hr)	0	0			0	0	1	1		0		0
Act Effct Green (s)		37.9			48.1	48.1	24.5	24.5		24.5		24.5
Actuated g/C Ratio		0.44			0.56	0.56	0.29	0.29		0.29		0.29
v/c Ratio		0.92			0.63	0.01	0.81	0.29		0.05		0.23
Control Delay		33.3			15.6	0.0	46.7	7.6		23.1		9.6
Queue Delay		0.0			0.0	0.0	0.0	0.0		0.0		0.0
Total Delay		33.3			15.6	0.0	46.7	7.6		23.1		9.6
LOS		C			B	A	D	A		C		A
Approach Delay		33.3			15.4			32.8				11.4
Approach LOS		C			B			C				B

Intersection Summary

Area Type: Other  
 Cycle Length: 97.6  
 Actuated Cycle Length: 85.5  
 Natural Cycle: 95  
 Control Type: Semi Act-Uncoord  
 Maximum v/c Ratio: 0.92  
 Intersection Signal Delay: 27.0  
 Intersection LOS: C  
 Intersection Capacity Utilization 83.0%  
 ICU Level of Service E  
 Analysis Period (min) 15

Splits and Phases: 15: Drummond Street/Dufferin Street & HWY 7

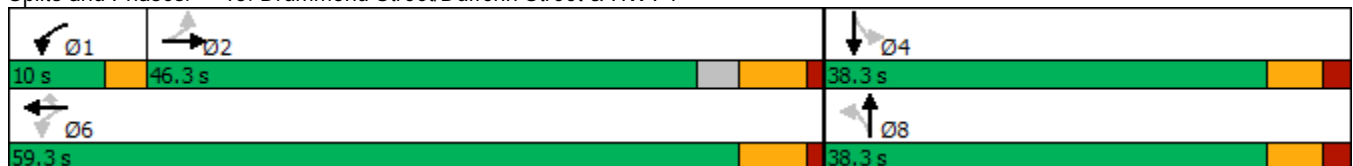

Perthmore Subdivision TIS  
 26: Wilson Street & Sunset Boulevard

Background 2030  
 PM Peak Hour



Lane Group	EBL	EBT	EBR	WBL	WBT	WBR	NBL	NBT	NBR	SBL	SBT	SBR
Lane Configurations		↖	↗		↔		↖	↗		↖	↗	↖
Traffic Volume (vph)	145	32	241	10	52	32	109	681	5	15	705	69
Future Volume (vph)	145	32	241	10	52	32	109	681	5	15	705	69
Ideal Flow (vphpl)	1900	1900	1900	1900	1900	1900	1900	1900	1900	1900	1900	1900
Storage Length (m)	0.0		0.0	0.0		0.0	15.0		0.0	25.0		0.0
Storage Lanes	0		1	0		0	1		0	1		1
Taper Length (m)	7.5			7.5			7.5			7.5		
Lane Util. Factor	1.00	1.00	1.00	1.00	1.00	1.00	1.00	1.00	1.00	1.00	1.00	1.00
Ped Bike Factor		0.97	0.95		0.98			1.00				0.91
Frt			0.850		0.954			0.999				0.850
Flt Protected		0.961			0.995		0.950			0.950		
Satd. Flow (prot)	0	1728	1583	0	1749	0	1770	1843	0	1805	1863	1615
Flt Permitted		0.741			0.959		0.137			0.162		
Satd. Flow (perm)	0	1299	1500	0	1681	0	255	1843	0	308	1863	1477
Right Turn on Red			Yes			Yes			Yes			Yes
Satd. Flow (RTOR)			229		42			1				113
Link Speed (k/h)		50			50			50				50
Link Distance (m)		238.8			244.8			341.7				185.2
Travel Time (s)		17.2			17.6			24.6				13.3
Confl. Peds. (#/hr)	23		20	20		23	40		18	18		40
Peak Hour Factor	0.93	0.93	0.93	0.77	0.77	0.77	0.87	0.87	0.87	0.83	0.83	0.83
Heavy Vehicles (%)	6%	4%	2%	0%	2%	0%	2%	3%	0%	0%	2%	0%
Adj. Flow (vph)	156	34	259	13	68	42	125	783	6	18	849	83
Shared Lane Traffic (%)												
Lane Group Flow (vph)	0	190	259	0	123	0	125	789	0	18	849	83
Enter Blocked Intersection	No	No	No	No	No	No	No	No	No	No	No	No
Lane Alignment	Left	Left	Right	Left	Left	Right	Left	Left	Right	Left	Left	Right
Median Width(m)		0.0			0.0			3.6				3.6
Link Offset(m)		0.0			0.0			0.0				0.0
Crosswalk Width(m)		4.8			4.8			4.8				4.8
Two way Left Turn Lane												
Headway Factor	1.00	1.00	1.00	1.00	1.00	1.00	1.00	1.00	1.00	1.00	1.00	1.00
Turning Speed (k/h)	25		15	25		15	25		15	25		15
Number of Detectors	1	1	1	1	2		1	2		1	2	1
Detector Template	Left		Right	Left	Thru			Thru			Thru	Right
Leading Detector (m)	2.0	10.0	2.0	2.0	10.0		2.0	10.0		2.0	10.0	2.0
Trailing Detector (m)	0.0	5.0	0.0	0.0	0.0		-1.0	0.0		-1.0	0.0	0.0
Detector 1 Position(m)	0.0	5.0	0.0	0.0	0.0		-1.0	0.0		-1.0	0.0	0.0
Detector 1 Size(m)	2.0	5.0	2.0	2.0	0.6		3.0	0.6		3.0	0.6	2.0
Detector 1 Type	Cl+Ex	Cl+Ex	Cl+Ex	Cl+Ex	Cl+Ex		Cl+Ex	Cl+Ex		Cl+Ex	Cl+Ex	Cl+Ex
Detector 1 Channel												
Detector 1 Extend (s)	0.0	0.0	0.0	0.0	0.0		0.0	0.0		0.0	0.0	0.0
Detector 1 Queue (s)	0.0	0.0	0.0	0.0	0.0		0.0	0.0		0.0	0.0	0.0
Detector 1 Delay (s)	0.0	0.0	0.0	0.0	0.0		0.0	0.0		0.0	0.0	0.0
Detector 2 Position(m)					9.4			9.4				9.4
Detector 2 Size(m)					0.6			0.6				0.6
Detector 2 Type					Cl+Ex			Cl+Ex				Cl+Ex
Detector 2 Channel												
Detector 2 Extend (s)					0.0			0.0				0.0

Perthmore Subdivision TIS  
26: Wilson Street & Sunset Boulevard

Background 2030  
PM Peak Hour



Lane Group	EBL	EBT	EBR	WBL	WBT	WBR	NBL	NBT	NBR	SBL	SBT	SBR
Turn Type	Perm	NA	Perm	Perm	NA		pm+pt	NA		pm+pt	NA	Perm
Protected Phases		4			8		5	2		1	6	
Permitted Phases	4		4	8			2			6		6
Detector Phase	4	4	4	8	8		5	2		1	6	6
Switch Phase							2			6		
Minimum Initial (s)	10.0	10.0	10.0	10.0	10.0		5.0	10.0		5.0	10.0	10.0
Minimum Split (s)	22.6	22.6	22.6	22.6	22.6		9.6	22.6		9.6	22.6	22.6
Total Split (s)	22.6	22.6	22.6	22.6	22.6		9.6	27.8		9.6	27.8	27.8
Total Split (%)	37.7%	37.7%	37.7%	37.7%	37.7%		16.0%	46.3%		16.0%	46.3%	46.3%
Maximum Green (s)	18.0	18.0	18.0	18.0	18.0		5.0	23.2		5.0	23.2	23.2
Yellow Time (s)	3.3	3.3	3.3	3.3	3.3		3.3	3.3		3.3	3.3	3.3
All-Red Time (s)	1.3	1.3	1.3	1.3	1.3		1.3	1.3		1.3	1.3	1.3
Lost Time Adjust (s)		0.0	0.0		0.0		0.0	0.0		0.0	0.0	0.0
Total Lost Time (s)		4.6	4.6		4.6		4.6	4.6		4.6	4.6	4.6
Lead/Lag							Lead	Lag		Lead	Lag	Lag
Lead-Lag Optimize?							Yes	Yes		Yes	Yes	Yes
Vehicle Extension (s)	3.0	3.0	3.0	3.0	3.0		3.0	3.0		3.0	3.0	3.0
Recall Mode	None	None	None	None	None		None	Min		None	Min	Min
Walk Time (s)	7.0	7.0	7.0	7.0	7.0			7.0			7.0	7.0
Flash Dont Walk (s)	11.0	11.0	11.0	11.0	11.0			11.0			11.0	11.0
Pedestrian Calls (#/hr)	15	15	15	33	33			18			18	18
Act Effct Green (s)		13.7	13.7		13.7		30.1	29.2		27.4	23.6	23.6
Actuated g/C Ratio		0.25	0.25		0.25		0.56	0.54		0.51	0.44	0.44
v/c Ratio		0.58	0.47		0.27		0.44	0.79		0.06	1.04	0.12
Control Delay		25.9	7.1		13.3		12.2	21.3		6.7	65.0	2.2
Queue Delay		0.0	0.0		0.0		0.0	0.0		0.0	0.0	0.0
Total Delay		25.9	7.1		13.3		12.2	21.3		6.7	65.0	2.2
LOS		C	A		B		B	C		A	E	A
Approach Delay		15.0			13.3			20.0			58.4	
Approach LOS		B			B			C			E	

Intersection Summary

Area Type: Other  
 Cycle Length: 60  
 Actuated Cycle Length: 53.9  
 Natural Cycle: 75  
 Control Type: Semi Act-Uncoord  
 Maximum v/c Ratio: 1.04  
 Intersection Signal Delay: 33.7  
 Intersection LOS: C  
 Intersection Capacity Utilization 77.4%  
 ICU Level of Service D  
 Analysis Period (min) 15

Splits and Phases: 26: Wilson Street & Sunset Boulevard

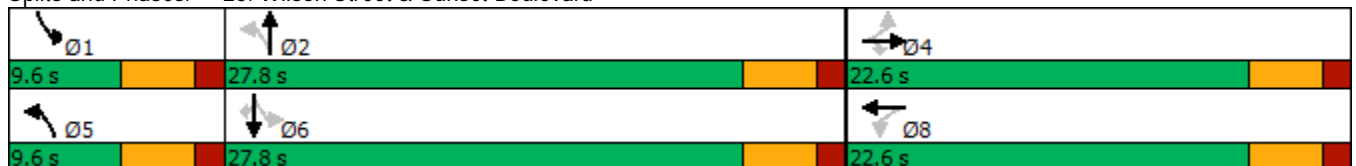

Perthmore Subdivision TIS  
 30: Wilson Street & Leslie Street/Isabella Street

Background 2030  
 PM Peak Hour



Lane Group	EBL	EBT	EBR	WBL	WBT	WBR	NBL	NBT	NBR	SBL	SBT	SBR
Lane Configurations		↕			↕		↕	↕		↕	↕	
Traffic Volume (vph)	129	27	6	33	31	79	3	635	4	41	732	51
Future Volume (vph)	129	27	6	33	31	79	3	635	4	41	732	51
Ideal Flow (vphpl)	1900	1900	1900	1900	1900	1900	1900	1900	1900	1900	1900	1900
Storage Length (m)	0.0		0.0	0.0		0.0	60.0		0.0	25.0		0.0
Storage Lanes	0		0	0		0	1		0	1		0
Taper Length (m)	7.5			7.5			25.0			15.0		
Lane Util. Factor	1.00	1.00	1.00	1.00	1.00	1.00	1.00	1.00	1.00	1.00	1.00	1.00
Ped Bike Factor		0.99			0.98			1.00		1.00	0.99	
Frt		0.995			0.925			0.999			0.990	
Flt Protected		0.962			0.988		0.950			0.950		
Satd. Flow (prot)	0	1772	0	0	1706	0	1805	1843	0	1703	1820	0
Flt Permitted		0.662			0.913		0.122			0.268		
Satd. Flow (perm)	0	1212	0	0	1569	0	232	1843	0	479	1820	0
Right Turn on Red			Yes			Yes			Yes			Yes
Satd. Flow (RTOR)		3			88			1			9	
Link Speed (k/h)		50			50			50			50	
Link Distance (m)		224.9			415.9			340.1			341.7	
Travel Time (s)		16.2			29.9			24.5			24.6	
Confl. Peds. (#/hr)	4		13	13		4	36		9	9		36
Peak Hour Factor	0.76	0.76	0.76	0.90	0.90	0.90	0.96	0.96	0.96	0.85	0.85	0.85
Heavy Vehicles (%)	3%	0%	0%	0%	0%	0%	0%	3%	0%	6%	3%	0%
Adj. Flow (vph)	170	36	8	37	34	88	3	661	4	48	861	60
Shared Lane Traffic (%)												
Lane Group Flow (vph)	0	214	0	0	159	0	3	665	0	48	921	0
Enter Blocked Intersection	No	No	No	No	No	No	No	No	No	No	No	No
Lane Alignment	Left	Left	Right	Left	Left	Right	Left	Left	Right	Left	Left	Right
Median Width(m)		0.0			0.0			3.6			3.6	
Link Offset(m)		0.0			0.0			0.0			0.0	
Crosswalk Width(m)		4.8			4.8			4.8			4.8	
Two way Left Turn Lane												
Headway Factor	1.00	1.00	1.00	1.00	1.00	1.00	1.00	1.00	1.00	1.00	1.00	1.00
Turning Speed (k/h)	25		15	25		15	25		15	25		15
Number of Detectors	1	2		1	2		1	2		1	2	
Detector Template	Left	Thru		Left	Thru		Left	Thru		Left	Thru	
Leading Detector (m)	2.0	10.0		2.0	10.0		2.0	10.0		2.0	10.0	
Trailing Detector (m)	0.0	0.0		0.0	0.0		0.0	0.0		0.0	0.0	
Detector 1 Position(m)	0.0	0.0		0.0	0.0		0.0	0.0		0.0	0.0	
Detector 1 Size(m)	2.0	0.6		2.0	0.6		2.0	0.6		2.0	0.6	
Detector 1 Type	Cl+Ex	Cl+Ex		Cl+Ex	Cl+Ex		Cl+Ex	Cl+Ex		Cl+Ex	Cl+Ex	
Detector 1 Channel												
Detector 1 Extend (s)	0.0	0.0		0.0	0.0		0.0	0.0		0.0	0.0	
Detector 1 Queue (s)	0.0	0.0		0.0	0.0		0.0	0.0		0.0	0.0	
Detector 1 Delay (s)	0.0	0.0		0.0	0.0		0.0	0.0		0.0	0.0	
Detector 2 Position(m)		9.4			9.4			9.4			9.4	
Detector 2 Size(m)		0.6			0.6			0.6			0.6	
Detector 2 Type		Cl+Ex			Cl+Ex			Cl+Ex			Cl+Ex	
Detector 2 Channel												
Detector 2 Extend (s)		0.0			0.0			0.0			0.0	

Perthmore Subdivision TIS  
 30: Wilson Street & Leslie Street/Isabella Street

Background 2030  
 PM Peak Hour



Lane Group	EBL	EBT	EBR	WBL	WBT	WBR	NBL	NBT	NBR	SBL	SBT	SBR
Turn Type	Perm	NA		Perm	NA		pm+pt	NA		pm+pt	NA	
Protected Phases		4			8		5	2		1	6	
Permitted Phases	4			8			2			6		
Detector Phase	4	4		8	8		5	2		1	6	
Switch Phase							2			6		
Minimum Initial (s)	10.0	10.0		10.0	10.0		5.0	10.0		5.0	10.0	
Minimum Split (s)	15.0	15.0		15.0	15.0		9.6	35.0		9.6	35.0	
Total Split (s)	15.0	15.0		15.0	15.0		9.6	35.4		9.6	35.4	
Total Split (%)	25.0%	25.0%		25.0%	25.0%		16.0%	59.0%		16.0%	59.0%	
Maximum Green (s)	10.4	10.4		10.4	10.4		5.0	30.8		5.0	30.8	
Yellow Time (s)	3.3	3.3		3.3	3.3		3.3	3.3		3.3	3.3	
All-Red Time (s)	1.3	1.3		1.3	1.3		1.3	1.3		1.3	1.3	
Lost Time Adjust (s)		0.0			0.0		0.0	0.0		0.0	0.0	
Total Lost Time (s)		4.6			4.6		4.6	4.6		4.6	4.6	
Lead/Lag							Lead	Lag		Lead	Lag	
Lead-Lag Optimize?							Yes	Yes		Yes	Yes	
Vehicle Extension (s)	3.0	3.0		3.0	3.0		3.0	3.0		3.0	3.0	
Recall Mode	None	None		None	None		None	Min		None	Min	
Walk Time (s)	5.0	5.0		5.0	5.0			7.0			7.0	
Flash Dont Walk (s)	5.0	5.0		5.0	5.0			11.0			11.0	
Pedestrian Calls (#/hr)	9	9		4	4			13			28	
Act Effect Green (s)		10.5			10.5		33.8	31.9		34.6	33.7	
Actuated g/C Ratio		0.19			0.19		0.61	0.58		0.63	0.61	
v/c Ratio		0.92			0.43		0.01	0.62		0.12	0.83	
Control Delay		70.9			14.7		3.7	12.2		4.2	18.8	
Queue Delay		0.0			0.0		0.0	0.0		0.0	0.0	
Total Delay		70.9			14.7		3.7	12.2		4.2	18.8	
LOS		E			B		A	B		A	B	
Approach Delay		70.9			14.7			12.2			18.0	
Approach LOS		E			B			B			B	

Intersection Summary

Area Type: Other  
 Cycle Length: 60  
 Actuated Cycle Length: 55.2  
 Natural Cycle: 90  
 Control Type: Semi Act-Uncoord  
 Maximum v/c Ratio: 0.92  
 Intersection Signal Delay: 21.5  
 Intersection LOS: C  
 Intersection Capacity Utilization 65.1%  
 ICU Level of Service C  
 Analysis Period (min) 15

Splits and Phases: 30: Wilson Street & Leslie Street/Isabella Street

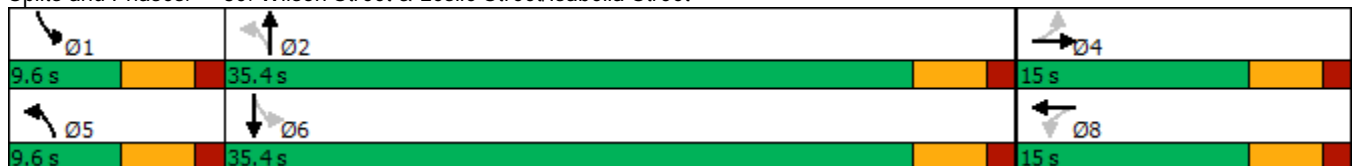

HCM 6th AWSC  
7: Drummond Street & North Street

Buildout Year 2030

Intersection	
Intersection Delay, s/veh	47.9
Intersection LOS	E

Movement	EBL	EBT	EBR	WBL	WBT	WBR	NBL	NBT	NBR	SBL	SBT	SBR
Lane Configurations		↕			↕			↕			↕	
Traffic Vol, veh/h	14	94	16	51	97	138	20	321	42	148	291	14
Future Vol, veh/h	14	94	16	51	97	138	20	321	42	148	291	14
Peak Hour Factor	0.85	0.85	0.85	0.85	0.85	0.85	0.89	0.89	0.89	0.85	0.85	0.85
Heavy Vehicles, %	0	6	0	0	5	1	0	0	0	0	0	0
Mvmt Flow	16	111	19	60	114	162	22	361	47	174	342	16
Number of Lanes	0	1	0	0	1	0	0	1	0	0	1	0

Approach	EB	WB	NB	SB
Opposing Approach	WB	EB	SB	NB
Opposing Lanes	1	1	1	1
Conflicting Approach Left	SB	NB	EB	WB
Conflicting Lanes Left	1	1	1	1
Conflicting Approach Right	NB	SB	WB	EB
Conflicting Lanes Right	1	1	1	1
HCM Control Delay	16	25.6	38.1	78.7
HCM LOS	C	D	E	F

Lane	NBLn1	EBLn1	WBLn1	SBLn1
Vol Left, %	5%	11%	18%	33%
Vol Thru, %	84%	76%	34%	64%
Vol Right, %	11%	13%	48%	3%
Sign Control	Stop	Stop	Stop	Stop
Traffic Vol by Lane	383	124	286	453
LT Vol	20	14	51	148
Through Vol	321	94	97	291
RT Vol	42	16	138	14
Lane Flow Rate	430	146	336	533
Geometry Grp	1	1	1	1
Degree of Util (X)	0.842	0.338	0.687	1.045
Departure Headway (Hd)	7.262	8.65	7.573	7.062
Convergence, Y/N	Yes	Yes	Yes	Yes
Cap	503	419	481	517
Service Time	5.262	6.65	5.573	5.062
HCM Lane V/C Ratio	0.855	0.348	0.699	1.031
HCM Control Delay	38.1	16	25.6	78.7
HCM Lane LOS	E	C	D	F
HCM 95th-tile Q	8.5	1.5	5.2	15.6

HCM 6th TWSC  
 3: Drummond Concession 2 & Perthmore

Buildout Year 2030

Intersection						
Int Delay, s/veh	1.3					
Movement	EBL	EBT	WBT	WBR	SBL	SBR
Lane Configurations		↕	↑	↗	↘	
Traffic Vol, veh/h	26	237	175	21	5	30
Future Vol, veh/h	26	237	175	21	5	30
Conflicting Peds, #/hr	0	0	0	0	0	0
Sign Control	Free	Free	Free	Free	Stop	Stop
RT Channelized	-	None	-	None	-	None
Storage Length	-	-	-	250	0	-
Veh in Median Storage, #	-	0	0	-	0	-
Grade, %	-	0	0	-	0	-
Peak Hour Factor	85	85	83	83	68	68
Heavy Vehicles, %	20	2	0	0	25	0
Mvmt Flow	31	279	211	25	7	44

Major/Minor	Major1	Major2	Minor2		
Conflicting Flow All	236	0	0	552	211
Stage 1	-	-	-	211	-
Stage 2	-	-	-	341	-
Critical Hdwy	4.3	-	-	6.65	6.2
Critical Hdwy Stg 1	-	-	-	5.65	-
Critical Hdwy Stg 2	-	-	-	5.65	-
Follow-up Hdwy	2.38	-	-	3.725	3.3
Pot Cap-1 Maneuver	1232	-	-	458	834
Stage 1	-	-	-	773	-
Stage 2	-	-	-	672	-
Platoon blocked, %	-	-	-	-	-
Mov Cap-1 Maneuver	1232	-	-	444	834
Mov Cap-2 Maneuver	-	-	-	444	-
Stage 1	-	-	-	750	-
Stage 2	-	-	-	672	-

Approach	EB	WB	SB
HCM Control Delay, s	0.8	0	10.2
HCM LOS			B

Minor Lane/Major Mvmt	EBL	EBT	WBT	WBR	SBLn1
Capacity (veh/h)	1232	-	-	-	741
HCM Lane V/C Ratio	0.025	-	-	-	0.069
HCM Control Delay (s)	8	0	-	-	10.2
HCM Lane LOS	A	A	-	-	B
HCM 95th %tile Q(veh)	0.1	-	-	-	0.2



**Intersection**

Int Delay, s/veh 1.6

**Movement** EBT EBR WBL WBT NBL NBR

Lane Configurations						
Traffic Vol, veh/h	76	13	18	90	10	13
Future Vol, veh/h	76	13	18	90	10	13
Conflicting Peds, #/hr	0	0	0	0	1	9
Sign Control	Free	Free	Free	Free	Stop	Stop
RT Channelized	-	None	-	None	-	None
Storage Length	-	-	-	-	0	-
Veh in Median Storage, #	0	-	-	0	0	-
Grade, %	0	-	-	0	0	-
Peak Hour Factor	78	78	72	72	75	75
Heavy Vehicles, %	2	0	0	1	0	10
Mvmt Flow	97	17	25	125	13	17

**Major/Minor** Major1 Major2 Minor1

Conflicting Flow All	0	0	114	0	282	115
Stage 1	-	-	-	-	106	-
Stage 2	-	-	-	-	176	-
Critical Hdwy	-	-	4.1	-	6.4	6.3
Critical Hdwy Stg 1	-	-	-	-	5.4	-
Critical Hdwy Stg 2	-	-	-	-	5.4	-
Follow-up Hdwy	-	-	2.2	-	3.5	3.39
Pot Cap-1 Maneuver	-	-	1488	-	712	916
Stage 1	-	-	-	-	923	-
Stage 2	-	-	-	-	859	-
Platoon blocked, %	-	-	-	-	-	-
Mov Cap-1 Maneuver	-	-	1488	-	698	909
Mov Cap-2 Maneuver	-	-	-	-	698	-
Stage 1	-	-	-	-	923	-
Stage 2	-	-	-	-	843	-

**Approach** EB WB NB

HCM Control Delay, s	0	1.2	9.7
HCM LOS			A

**Minor Lane/Major Mvmt** NBLn1 EBT EBR WBL WBT

Capacity (veh/h)	803	-	-	1488	-
HCM Lane V/C Ratio	0.038	-	-	0.017	-
HCM Control Delay (s)	9.7	-	-	7.5	0
HCM Lane LOS	A	-	-	A	A
HCM 95th %tile Q(veh)	0.1	-	-	0.1	-

HCM 6th TWSC  
34: Wilson Street & North Street

Buildout Year 2030

Intersection												
Int Delay, s/veh	6											
Movement	EBL	EBT	EBR	WBL	WBT	WBR	NBL	NBT	NBR	SBL	SBT	SBR
Lane Configurations		↕			↕			↕			↕	
Traffic Vol, veh/h	6	5	13	12	10	128	12	494	27	143	581	29
Future Vol, veh/h	6	5	13	12	10	128	12	494	27	143	581	29
Conflicting Peds, #/hr	5	0	9	9	0	5	20	0	19	19	0	20
Sign Control	Stop	Stop	Stop	Stop	Stop	Stop	Free	Free	Free	Free	Free	Free
RT Channelized	-	-	None	-	-	None	-	-	None	-	-	None
Storage Length	-	-	-	-	-	-	-	-	-	-	-	650
Veh in Median Storage, #	-	0	-	-	0	-	-	0	-	-	0	-
Grade, %	-	0	-	-	0	-	-	0	-	-	0	-
Peak Hour Factor	68	68	68	94	94	94	89	89	89	96	96	96
Heavy Vehicles, %	20	0	0	0	0	7	0	1	0	12	1	0
Mvmt Flow	9	7	19	13	11	136	13	555	30	149	605	30

Major/Minor	Minor2		Minor1		Major1			Major2				
Conflicting Flow All	1613	1568	347	1228	1568	594	655	0	0	604	0	0
Stage 1	938	938	-	615	615	-	-	-	-	-	-	-
Stage 2	675	630	-	613	953	-	-	-	-	-	-	-
Critical Hdwy	7.6	6.5	6.9	7.3	6.5	6.305	4.1	-	-	4.28	-	-
Critical Hdwy Stg 1	6.8	5.5	-	6.1	5.5	-	-	-	-	-	-	-
Critical Hdwy Stg 2	6.4	5.5	-	6.5	5.5	-	-	-	-	-	-	-
Follow-up Hdwy	3.69	4	3.3	3.5	4.3	3.665	2.2	-	-	2.314	-	-
Pot Cap-1 Maneuver	66	112	655	146	112	492	942	-	-	915	-	-
Stage 1	258	346	-	482	485	-	-	-	-	-	-	-
Stage 2	407	478	-	451	340	-	-	-	-	-	-	-
Platoon blocked, %								-	-	-	-	-
Mov Cap-1 Maneuver	33	79	639	102	79	482	926	-	-	900	-	-
Mov Cap-2 Maneuver	33	79	-	102	79	-	-	-	-	-	-	-
Stage 1	248	253	-	464	467	-	-	-	-	-	-	-
Stage 2	278	460	-	313	248	-	-	-	-	-	-	-

Approach	EB		WB		NB		SB	
HCM Control Delay, s	68.7		30.9		0.2		2.5	
HCM LOS	F		D					

Minor Lane/Major Mvmt	NBL	NBT	NBR	EBLn1	WBLn1	SBL	SBT	SBR
Capacity (veh/h)	926	-	-	90	294	900	-	-
HCM Lane V/C Ratio	0.015	-	-	0.392	0.543	0.166	-	-
HCM Control Delay (s)	8.9	0	-	68.7	30.9	9.8	0.8	-
HCM Lane LOS	A	A	-	F	D	A	A	-
HCM 95th %tile Q(veh)	0	-	-	1.6	3	0.6	-	-

Perthmore Subdivision TIS  
 12: Wilson Street /Canadian tire Ent/Ext & HWY 7

Background 2035  
 AM Peak Hour



Lane Group	EBL	EBT	EBR	WBL	WBT	WBR	NBL	NBT	NBR	SBL	SBT	SBR
Lane Configurations		↕↕			↕↕			↕	↗		↕	↗
Traffic Volume (vph)	80	550	313	251	689	14	384	80	256	55	78	122
Future Volume (vph)	80	550	313	251	689	14	384	80	256	55	78	122
Ideal Flow (vphpl)	1900	1900	1900	1900	1900	1900	1900	1900	1900	1900	1900	1900
Storage Length (m)	0.0		0.0	0.0		0.0	0.0		60.0	30.0		0.0
Storage Lanes	0		0	0		0	0		1	1		1
Taper Length (m)	7.5			7.5			7.5			10.0		
Lane Util. Factor	0.95	0.95	0.95	0.95	0.95	0.95	1.00	1.00	1.00	1.00	1.00	1.00
Ped Bike Factor									0.99		1.00	
Frt		0.950			0.998				0.850			0.850
Flt Protected		0.996			0.987			0.960			0.980	
Satd. Flow (prot)	0	3314	0	0	3406	0	0	1766	1509	0	1782	1583
Flt Permitted		0.702			0.525			0.609			0.665	
Satd. Flow (perm)	0	2336	0	0	1812	0	0	1120	1488	0	1209	1583
Right Turn on Red			Yes			Yes			Yes			Yes
Satd. Flow (RTOR)		81			2				254			133
Link Speed (k/h)		60			60			50			50	
Link Distance (m)		455.2			323.0			407.8			562.7	
Travel Time (s)		27.3			19.4			29.4			40.5	
Confl. Peds. (#/hr)									2	2		
Peak Hour Factor	0.91	0.91	0.91	0.96	0.96	0.96	0.94	0.94	0.94	0.92	0.92	0.92
Heavy Vehicles (%)	0%	3%	4%	0%	6%	5%	4%	0%	7%	8%	2%	2%
Adj. Flow (vph)	88	604	344	261	718	15	409	85	272	60	85	133
Shared Lane Traffic (%)												
Lane Group Flow (vph)	0	1036	0	0	994	0	0	494	272	0	145	133
Enter Blocked Intersection	No	No	No	No	No	No	No	No	No	No	No	No
Lane Alignment	Left	Left	Right	Left	Left	Right	Left	Left	Right	Left	Left	Right
Median Width(m)		0.0			0.0			0.0			0.0	
Link Offset(m)		0.0			0.0			0.0			0.0	
Crosswalk Width(m)		4.8			4.8			4.8			4.8	
Two way Left Turn Lane												
Headway Factor	1.00	1.00	1.00	1.00	1.00	1.00	1.00	1.00	1.00	1.00	1.00	1.00
Turning Speed (k/h)	25		15	25		15	25		15	25		15
Number of Detectors	1	2		1	2		1	1	1	1	1	1
Detector Template	Left			Left			Left			Left		
Leading Detector (m)	2.0	98.8		2.0	91.8		2.0	9.0	9.0	2.0	9.0	9.0
Trailing Detector (m)	0.0	-3.0		0.0	-3.0		0.0	-3.0	-3.0	0.0	-0.2	-3.0
Detector 1 Position(m)	0.0	-3.0		0.0	-3.0		0.0	-3.0	-3.0	0.0	-0.2	-3.0
Detector 1 Size(m)	2.0	12.0		2.0	12.0		2.0	12.0	12.0	2.0	9.2	12.0
Detector 1 Type	Cl+Ex	Cl+Ex		Cl+Ex	Cl+Ex		Cl+Ex	Cl+Ex	Cl+Ex	Cl+Ex	Cl+Ex	Cl+Ex
Detector 1 Channel												
Detector 1 Extend (s)	0.0	0.0		0.0	0.0		0.0	0.0	0.0	0.0	0.0	0.0
Detector 1 Queue (s)	0.0	0.0		0.0	0.0		0.0	0.0	0.0	0.0	0.0	0.0
Detector 1 Delay (s)	0.0	0.0		0.0	0.0		0.0	0.0	0.0	0.0	0.0	0.0
Detector 2 Position(m)		97.0			90.0							
Detector 2 Size(m)		1.8			1.8							
Detector 2 Type		Cl+Ex			Cl+Ex							
Detector 2 Channel												
Detector 2 Extend (s)		0.0			0.0							

Perthmore Subdivision TIS  
 12: Wilson Street /Canadian tire Ent/Ext & HWY 7

Background 2035  
 AM Peak Hour



Lane Group	EBL	EBT	EBR	WBL	WBT	WBR	NBL	NBT	NBR	SBL	SBT	SBR
Turn Type	Perm	NA		pm+pt	NA		pm+pt	NA	Perm	Perm	NA	Perm
Protected Phases		2		1	6		3	8			4	
Permitted Phases	2			6			8		8	4		4
Detector Phase	2	2		1	1 6		3	3 8	8	4	4	4
Switch Phase												
Minimum Initial (s)	20.0	20.0		7.0	20.0		7.0	10.0	10.0	10.0	10.0	10.0
Minimum Split (s)	43.9	43.9		9.0	43.9		9.0	37.4	37.4	37.4	37.4	37.4
Total Split (s)	43.9	43.9		16.0	59.9		16.0	53.4	53.4	37.4	37.4	37.4
Total Split (%)	38.7%	38.7%		14.1%	52.9%		14.1%	47.1%	47.1%	33.0%	33.0%	33.0%
Maximum Green (s)	37.0	37.0		14.0	53.0		14.0	47.0	47.0	31.0	31.0	31.0
Yellow Time (s)	5.0	5.0		2.0	5.0		2.0	4.1	4.1	4.1	4.1	4.1
All-Red Time (s)	1.9	1.9		0.0	1.9		0.0	2.3	2.3	2.3	2.3	2.3
Lost Time Adjust (s)		0.0			0.0			0.0	0.0		0.0	0.0
Total Lost Time (s)		6.9			6.9			6.4	6.4		6.4	6.4
Lead/Lag	Lag	Lag		Lead			Lead			Lag	Lag	Lag
Lead-Lag Optimize?	Yes	Yes		Yes			Yes			Yes	Yes	Yes
Vehicle Extension (s)	4.5	4.5		2.0	4.5		2.0	3.0	3.0	3.0	3.0	3.0
Recall Mode	Min	Min		None	Min		None	None	None	None	None	None
Walk Time (s)	7.0	7.0			7.0			7.0	7.0	7.0	7.0	7.0
Flash Dont Walk (s)	30.0	30.0			30.0			24.0	24.0	24.0	24.0	24.0
Pedestrian Calls (#/hr)	0	0			0			1	1	0	0	0
Act Effct Green (s)		37.0			53.0			46.7	46.7		30.7	30.7
Actuated g/C Ratio		0.33			0.47			0.41	0.41		0.27	0.27
v/c Ratio		1.26			1.18dl			0.96	0.36		0.44	0.25
Control Delay		160.3			60.7			61.3	4.8		39.2	6.7
Queue Delay		0.0			0.0			0.0	0.0		0.0	0.0
Total Delay		160.3			60.7			61.3	4.8		39.2	6.7
LOS		F			E			E	A		D	A
Approach Delay		160.3			60.7			41.2			23.6	
Approach LOS		F			E			D			C	

Intersection Summary

Area Type: Other  
 Cycle Length: 113.3  
 Actuated Cycle Length: 113  
 Natural Cycle: 150  
 Control Type: Semi Act-Uncoord  
 Maximum v/c Ratio: 1.26  
 Intersection Signal Delay: 86.0  
 Intersection LOS: F  
 Intersection Capacity Utilization 103.3%  
 ICU Level of Service G  
 Analysis Period (min) 15  
 dl Defacto Left Lane. Recode with 1 though lane as a left lane.

Splits and Phases: 12: Wilson Street /Canadian tire Ent/Ext & HWY 7

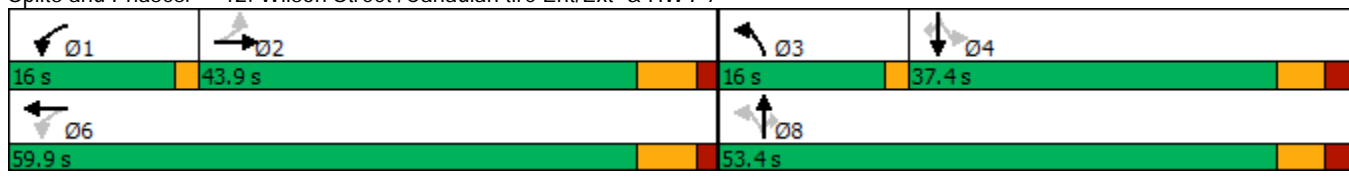

Perthmore Subdivision TIS  
 15: Drummond Street/Dufferin Street & HWY 7

Background 2035  
 AM Peak Hour



Lane Group	EBL	EBT	EBR	WBL	WBT	WBR	NBL	NBT	NBR	SBL	SBT	SBR
Lane Configurations		↕↕			↕↕	↗	↖	↗	↖	↖	↗	
Traffic Volume (vph)	98	423	245	138	592	23	297	68	142	19	65	113
Future Volume (vph)	98	423	245	138	592	23	297	68	142	19	65	113
Ideal Flow (vphpl)	1900	1900	1900	1900	1900	1900	1900	1900	1900	1900	1900	1900
Storage Length (m)	0.0		0.0	0.0		15.0	65.0		0.0	40.0		0.0
Storage Lanes	0		0	0		1	1		0	1		0
Taper Length (m)	7.5			7.5			0.0			20.0		
Lane Util. Factor	0.95	0.95	0.95	0.95	0.95	1.00	1.00	1.00	1.00	1.00	1.00	1.00
Ped Bike Factor								0.99		1.00		
Frt		0.952				0.850		0.899				0.905
Flt Protected		0.994			0.991		0.950			0.950		
Satd. Flow (prot)	0	3253	0	0	3317	1429	1770	1659	0	1671	1678	0
Flt Permitted		0.707			0.563		0.550			0.536		
Satd. Flow (perm)	0	2314	0	0	1884	1429	1025	1659	0	942	1678	0
Right Turn on Red			Yes			Yes			Yes			Yes
Satd. Flow (RTOR)		97				37		115				96
Link Speed (k/h)		60			60			50				50
Link Distance (m)		323.0			161.3			376.3				232.6
Travel Time (s)		19.4			9.7			27.1				16.7
Confl. Peds. (#/hr)									2	2		
Peak Hour Factor	0.91	0.91	0.91	0.90	0.90	0.90	0.87	0.87	0.87	0.77	0.77	0.77
Heavy Vehicles (%)	4%	7%	2%	3%	9%	13%	2%	2%	2%	8%	5%	1%
Adj. Flow (vph)	108	465	269	153	658	26	341	78	163	25	84	147
Shared Lane Traffic (%)												
Lane Group Flow (vph)	0	842	0	0	811	26	341	241	0	25	231	0
Enter Blocked Intersection	No	No	No	No	No	No	No	No	No	No	No	No
Lane Alignment	Left	Left	Right	Left	Left	Right	Left	Left	Right	Left	Left	Right
Median Width(m)		0.0			0.0			3.6			3.6	
Link Offset(m)		0.0			0.0			0.0			0.0	
Crosswalk Width(m)		4.8			4.8			4.8			4.8	
Two way Left Turn Lane												
Headway Factor	1.00	1.00	1.00	1.00	1.00	1.00	1.00	1.00	1.00	1.00	1.00	1.00
Turning Speed (k/h)	25		15	25		15	25		15	25		15
Number of Detectors	1	1		1	2	0	1	1		1	1	
Detector Template	Left			Left		Right						
Leading Detector (m)	2.0	94.8		2.0	86.8	0.0	9.0	9.0		9.0	9.0	
Trailing Detector (m)	0.0	93.0		0.0	-1.0	0.0	-3.0	-3.0		-3.0	-3.0	
Detector 1 Position(m)	0.0	93.0		0.0	-1.0	0.0	-3.0	-3.0		-3.0	-3.0	
Detector 1 Size(m)	2.0	1.8		2.0	12.0	2.0	12.0	12.0		12.0	12.0	
Detector 1 Type	Cl+Ex	Cl+Ex		Cl+Ex	Cl+Ex	Cl+Ex	Cl+Ex	Cl+Ex		Cl+Ex	Cl+Ex	
Detector 1 Channel												
Detector 1 Extend (s)	0.0	0.0		0.0	0.0	0.0	0.0	0.0		0.0	0.0	
Detector 1 Queue (s)	0.0	0.0		0.0	0.0	0.0	0.0	0.0		0.0	0.0	
Detector 1 Delay (s)	0.0	0.0		0.0	0.0	0.0	0.0	0.0		0.0	0.0	
Detector 2 Position(m)					85.0							
Detector 2 Size(m)					1.8							
Detector 2 Type					Cl+Ex							
Detector 2 Channel												
Detector 2 Extend (s)					0.0							

Perthmore Subdivision TIS  
 15: Drummond Street/Dufferin Street & HWY 7

Background 2035  
 AM Peak Hour



Lane Group	EBL	EBT	EBR	WBL	WBT	WBR	NBL	NBT	NBR	SBL	SBT	SBR
Turn Type	Perm	NA		pm+pt	NA	Perm	Perm	NA		Perm	NA	
Protected Phases		2		1	6			8				4
Permitted Phases	2			6		6	8			4		
Detector Phase	2	2		1	1 6	6	8	8		4		4
Switch Phase												
Minimum Initial (s)	20.0	20.0		7.0	20.0	20.0	10.0	10.0		10.0		10.0
Minimum Split (s)	33.3	33.3		10.0	36.3	36.3	38.3	38.3		38.3		38.3
Total Split (s)	46.3	46.3		13.0	59.3	59.3	38.3	38.3		38.3		38.3
Total Split (%)	47.4%	47.4%		13.3%	60.8%	60.8%	39.2%	39.2%		39.2%		39.2%
Maximum Green (s)	40.0	40.0		10.0	53.0	53.0	32.0	32.0		32.0		32.0
Yellow Time (s)	5.0	5.0		3.0	5.0	5.0	4.1	4.1		4.1		4.1
All-Red Time (s)	1.3	1.3		0.0	1.3	1.3	2.2	2.2		2.2		2.2
Lost Time Adjust (s)		0.0			0.0	0.0	0.0	0.0		0.0		0.0
Total Lost Time (s)		6.3			6.3	6.3	6.3	6.3		6.3		6.3
Lead/Lag	Lag	Lag		Lead								
Lead-Lag Optimize?	Yes	Yes		Yes								
Vehicle Extension (s)	4.6	4.6		3.0	4.6	4.6	3.0	3.0		3.0		3.0
Recall Mode	Max	Max		None	Max	Max	None	None		None		None
Walk Time (s)	7.0	7.0			7.0	7.0	7.0	7.0		7.0		7.0
Flash Dont Walk (s)	20.0	20.0			20.0	20.0	25.0	25.0		25.0		25.0
Pedestrian Calls (#/hr)	0	0			0	0	1	1		0		0
Act Effct Green (s)		40.0			53.0	53.0	32.0	32.0		32.0		32.0
Actuated g/C Ratio		0.41			0.54	0.54	0.33	0.33		0.33		0.33
v/c Ratio		0.84			0.72	0.03	1.01	0.39		0.08		0.38
Control Delay		31.8			19.5	2.5	87.6	14.9		23.7		16.3
Queue Delay		0.0			0.0	0.0	0.0	0.0		0.0		0.0
Total Delay		31.8			19.5	2.5	87.6	14.9		23.7		16.3
LOS		C			B	A	F	B		C		B
Approach Delay		31.8			19.0			57.5				17.1
Approach LOS		C			B			E				B

Intersection Summary

Area Type: Other  
 Cycle Length: 97.6  
 Actuated Cycle Length: 97.6  
 Natural Cycle: 85  
 Control Type: Semi Act-Uncoord  
 Maximum v/c Ratio: 1.01  
 Intersection Signal Delay: 32.0  
 Intersection LOS: C  
 Intersection Capacity Utilization 90.6%  
 ICU Level of Service E  
 Analysis Period (min) 15

Splits and Phases: 15: Drummond Street/Dufferin Street & HWY 7

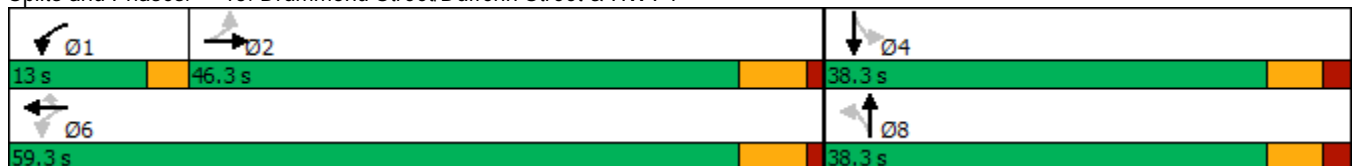

Perthmore Subdivision TIS  
26: Wilson Street & Sunset Boulevard

Background 2035  
AM Peak Hour



Lane Group	EBL	EBT	EBR	WBL	WBT	WBR	NBL	NBT	NBR	SBL	SBT	SBR
Lane Configurations		↕	↗		↕		↗	↖		↖	↕	↗
Traffic Volume (vph)	107	17	203	13	54	22	130	443	0	6	523	67
Future Volume (vph)	107	17	203	13	54	22	130	443	0	6	523	67
Ideal Flow (vphpl)	1900	1900	1900	1900	1900	1900	1900	1900	1900	1900	1900	1900
Storage Length (m)	0.0		0.0	0.0		0.0	15.0		0.0	25.0		0.0
Storage Lanes	0		1	0		0	1		0	1		1
Taper Length (m)	7.5			7.5			7.5			7.5		
Lane Util. Factor	1.00	1.00	1.00	1.00	1.00	1.00	1.00	1.00	1.00	1.00	1.00	1.00
Ped Bike Factor		0.97	0.97		0.98							0.93
Frt			0.850		0.967							0.850
Flt Protected		0.959			0.993		0.950			0.950		
Satd. Flow (prot)	0	1704	1524	0	1761	0	1770	1792	0	1770	1810	1583
Flt Permitted		0.715			0.937		0.190			0.377		
Satd. Flow (perm)	0	1228	1483	0	1661	0	354	1792	0	702	1810	1476
Right Turn on Red			Yes			Yes			Yes			Yes
Satd. Flow (RTOR)			285		28							112
Link Speed (k/h)		50			50			50				50
Link Distance (m)		147.8			117.2			341.7				254.9
Travel Time (s)		10.6			8.4			24.6				18.4
Confl. Peds. (#/hr)	30		4	4		30			6			29
Peak Hour Factor	0.55	0.55	0.55	0.64	0.64	0.64	0.92	0.85	0.85	0.92	0.86	0.86
Heavy Vehicles (%)	8%	0%	6%	0%	3%	0%	2%	6%	0%	2%	5%	2%
Adj. Flow (vph)	195	31	369	20	84	34	141	521	0	7	608	78
Shared Lane Traffic (%)												
Lane Group Flow (vph)	0	226	369	0	138	0	141	521	0	7	608	78
Enter Blocked Intersection	No	No	No	No	No	No	No	No	No	No	No	No
Lane Alignment	Left	Left	Right	Left	Left	Right	Left	Left	Right	Left	Left	Right
Median Width(m)		0.0			0.0			3.6				3.6
Link Offset(m)		0.0			0.0			0.0				0.0
Crosswalk Width(m)		4.8			4.8			4.8				4.8
Two way Left Turn Lane												
Headway Factor	1.00	1.00	1.00	1.00	1.00	1.00	1.00	1.00	1.00	1.00	1.00	1.00
Turning Speed (k/h)	25		15	25		15	25		15	25		15
Number of Detectors	1	2	1	1	2		1	2		1	2	1
Detector Template	Left		Right	Left	Thru			Thru			Thru	Right
Leading Detector (m)	2.0	10.0	2.0	2.0	10.0		4.0	10.0		4.0	10.0	2.0
Trailing Detector (m)	0.0	5.0	0.0	0.0	0.0		-1.0	0.0		-1.0	0.0	0.0
Detector 1 Position(m)	0.0	5.0	0.0	0.0	0.0		-1.0	0.0		-1.0	0.0	0.0
Detector 1 Size(m)	2.0	5.0	2.0	2.0	0.6		5.0	0.6		5.0	0.6	2.0
Detector 1 Type	Cl+Ex	Cl+Ex	Cl+Ex	Cl+Ex	Cl+Ex		Cl+Ex	Cl+Ex		Cl+Ex	Cl+Ex	Cl+Ex
Detector 1 Channel												
Detector 1 Extend (s)	0.0	0.0	0.0	0.0	0.0		0.0	0.0		0.0	0.0	0.0
Detector 1 Queue (s)	0.0	0.0	0.0	0.0	0.0		0.0	0.0		0.0	0.0	0.0
Detector 1 Delay (s)	0.0	0.0	0.0	0.0	0.0		0.0	0.0		0.0	0.0	0.0
Detector 2 Position(m)		9.4			9.4			9.4				9.4
Detector 2 Size(m)		0.6			0.6			0.6				0.6
Detector 2 Type		Cl+Ex			Cl+Ex			Cl+Ex				Cl+Ex
Detector 2 Channel												
Detector 2 Extend (s)		0.0			0.0			0.0				0.0



Perthmore Subdivision TIS  
26: Wilson Street & Sunset Boulevard

Background 2035  
AM Peak Hour



Lane Group	EBL	EBT	EBR	WBL	WBT	WBR	NBL	NBT	NBR	SBL	SBT	SBR
Turn Type	Perm	NA	Perm	Perm	NA		pm+pt	NA		pm+pt	NA	Perm
Protected Phases		4			8		5	2		1	6	
Permitted Phases	4		4	8			2			6		6
Detector Phase	4	4	4	8	8		5	2		1	6	6
Switch Phase												
Minimum Initial (s)	10.0	10.0	10.0	10.0	10.0		5.0	10.0		5.0	10.0	10.0
Minimum Split (s)	22.6	22.6	22.6	22.6	22.6		9.6	22.6		9.6	22.6	22.6
Total Split (s)	22.6	22.6	22.6	22.6	22.6		9.6	28.0		9.6	28.0	28.0
Total Split (%)	37.5%	37.5%	37.5%	37.5%	37.5%		15.9%	46.5%		15.9%	46.5%	46.5%
Maximum Green (s)	18.0	18.0	18.0	18.0	18.0		5.0	23.4		5.0	23.4	23.4
Yellow Time (s)	3.3	3.3	3.3	3.3	3.3		3.3	3.3		3.3	3.3	3.3
All-Red Time (s)	1.3	1.3	1.3	1.3	1.3		1.3	1.3		1.3	1.3	1.3
Lost Time Adjust (s)		0.0	0.0		0.0		0.0	0.0		0.0	0.0	0.0
Total Lost Time (s)		4.6	4.6		4.6		4.6	4.6		4.6	4.6	4.6
Lead/Lag							Lead	Lag		Lead	Lag	Lag
Lead-Lag Optimize?							Yes	Yes		Yes	Yes	Yes
Vehicle Extension (s)	3.0	3.0	3.0	3.0	3.0		3.0	3.0		3.0	3.0	3.0
Recall Mode	None	None	None	None	None		None	Min		None	Min	Min
Walk Time (s)	7.0	7.0	7.0	7.0	7.0			7.0			7.0	7.0
Flash Dont Walk (s)	11.0	11.0	11.0	11.0	11.0			11.0			11.0	11.0
Pedestrian Calls (#/hr)	6	6	6	22	22			22			4	4
Act Effct Green (s)		14.9	14.9		14.9		27.1	26.2		24.5	20.9	20.9
Actuated g/C Ratio		0.28	0.28		0.28		0.52	0.50		0.47	0.40	0.40
v/c Ratio		0.65	0.59		0.28		0.43	0.58		0.02	0.85	0.12
Control Delay		28.5	9.3		15.3		10.9	14.4		6.3	29.5	2.0
Queue Delay		0.0	0.0		0.0		0.0	0.0		0.0	0.0	0.0
Total Delay		28.5	9.3		15.3		10.9	14.4		6.3	29.5	2.0
LOS		C	A		B		B	B		A	C	A
Approach Delay		16.6			15.3			13.6			26.2	
Approach LOS		B			B			B			C	

Intersection Summary

Area Type: Other  
 Cycle Length: 60.2  
 Actuated Cycle Length: 52.5  
 Natural Cycle: 60  
 Control Type: Semi Act-Uncoord  
 Maximum v/c Ratio: 0.85  
 Intersection Signal Delay: 18.8  
 Intersection LOS: B  
 Intersection Capacity Utilization 64.8%  
 ICU Level of Service C  
 Analysis Period (min) 15

Splits and Phases: 26: Wilson Street & Sunset Boulevard

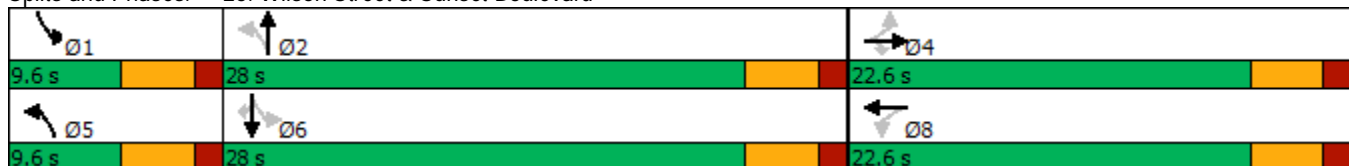

Perthmore Subdivision TIS  
 30: Wilson Street & Leslie Street/Isabella Street

Background 2035  
 AM Peak Hour



Lane Group	EBL	EBT	EBR	WBL	WBT	WBR	NBL	NBT	NBR	SBL	SBT	SBR
Lane Configurations		↕			↕		↗	↘		↗	↘	
Traffic Volume (vph)	30	12	3	20	10	65	0	465	3	49	581	32
Future Volume (vph)	30	12	3	20	10	65	0	465	3	49	581	32
Ideal Flow (vphpl)	1900	1900	1900	1900	1900	1900	1900	1900	1900	1900	1900	1900
Storage Length (m)	0.0		0.0	0.0		0.0	60.0		0.0	25.0		0.0
Storage Lanes	0		0	0		0	1		0	1		0
Taper Length (m)	7.5			7.5			25.0			15.0		
Lane Util. Factor	1.00	1.00	1.00	1.00	1.00	1.00	1.00	1.00	1.00	1.00	1.00	1.00
Ped Bike Factor		0.97			0.94			1.00		0.99	1.00	
Frt		0.991			0.908			0.999			0.992	
Flt Protected		0.968			0.990					0.950		
Satd. Flow (prot)	0	1522	0	0	1545	0	1900	1758	0	1752	1745	0
Flt Permitted		0.734			0.911					0.322		
Satd. Flow (perm)	0	1117	0	0	1418	0	1900	1758	0	589	1745	0
Right Turn on Red			Yes			Yes			Yes			Yes
Satd. Flow (RTOR)		4			90			1			7	
Link Speed (k/h)		50			50			50			50	
Link Distance (m)		91.6			415.9			340.1			341.7	
Travel Time (s)		6.6			29.9			24.5			24.6	
Confl. Peds. (#/hr)	23		4	4		23	6		16	16		6
Peak Hour Factor	0.78	0.78	0.78	0.72	0.72	0.72	0.82	0.82	0.82	0.82	0.82	0.82
Heavy Vehicles (%)	24%	0%	50%	0%	14%	4%	0%	8%	0%	3%	7%	23%
Adj. Flow (vph)	38	15	4	28	14	90	0	567	4	60	709	39
Shared Lane Traffic (%)												
Lane Group Flow (vph)	0	57	0	0	132	0	0	571	0	60	748	0
Enter Blocked Intersection	No	No	No	No	No	No	No	No	No	No	No	No
Lane Alignment	Left	Left	Right	Left	Left	Right	Left	Left	Right	Left	Left	Right
Median Width(m)		0.0			0.0			3.6			3.6	
Link Offset(m)		0.0			0.0			0.0			0.0	
Crosswalk Width(m)		4.8			4.8			4.8			4.8	
Two way Left Turn Lane												
Headway Factor	1.00	1.00	1.00	1.00	1.00	1.00	1.00	1.00	1.00	1.00	1.00	1.00
Turning Speed (k/h)	25		15	25		15	25		15	25		15
Number of Detectors	1	2		1	2		1	2		1	2	
Detector Template	Left	Thru		Left	Thru		Left	Thru		Left	Thru	
Leading Detector (m)	2.0	10.0		2.0	10.0		2.0	10.0		2.0	10.0	
Trailing Detector (m)	0.0	0.0		0.0	0.0		0.0	0.0		0.0	0.0	
Detector 1 Position(m)	0.0	0.0		0.0	0.0		0.0	0.0		0.0	0.0	
Detector 1 Size(m)	2.0	0.6		2.0	0.6		2.0	0.6		2.0	0.6	
Detector 1 Type	Cl+Ex	Cl+Ex		Cl+Ex	Cl+Ex		Cl+Ex	Cl+Ex		Cl+Ex	Cl+Ex	
Detector 1 Channel												
Detector 1 Extend (s)	0.0	0.0		0.0	0.0		0.0	0.0		0.0	0.0	
Detector 1 Queue (s)	0.0	0.0		0.0	0.0		0.0	0.0		0.0	0.0	
Detector 1 Delay (s)	0.0	0.0		0.0	0.0		0.0	0.0		0.0	0.0	
Detector 2 Position(m)		9.4			9.4			9.4			9.4	
Detector 2 Size(m)		0.6			0.6			0.6			0.6	
Detector 2 Type		Cl+Ex			Cl+Ex			Cl+Ex			Cl+Ex	
Detector 2 Channel												
Detector 2 Extend (s)		0.0			0.0			0.0			0.0	

Perthmore Subdivision TIS  
 30: Wilson Street & Leslie Street/Isabella Street

Background 2035  
 AM Peak Hour



Lane Group	EBL	EBT	EBR	WBL	WBT	WBR	NBL	NBT	NBR	SBL	SBT	SBR
Turn Type	Perm	NA		Perm	NA		pm+pt	NA		pm+pt	NA	
Protected Phases		4			8		5	2		1	6	
Permitted Phases	4			8			2			6		
Detector Phase	4	4		8	8		5	2		1	6	
Switch Phase							2			6		
Minimum Initial (s)	10.0	10.0		10.0	10.0		5.0	10.0		5.0	10.0	
Minimum Split (s)	15.1	15.1		15.1	15.1		9.6	35.0		9.6	35.0	
Total Split (s)	15.1	15.1		15.1	15.1		9.6	35.3		9.6	35.3	
Total Split (%)	25.2%	25.2%		25.2%	25.2%		16.0%	58.8%		16.0%	58.8%	
Maximum Green (s)	10.5	10.5		10.5	10.5		5.0	30.7		5.0	30.7	
Yellow Time (s)	3.3	3.3		3.3	3.3		3.3	3.3		3.3	3.3	
All-Red Time (s)	1.3	1.3		1.3	1.3		1.3	1.3		1.3	1.3	
Lost Time Adjust (s)		0.0			0.0		0.0	0.0		0.0	0.0	
Total Lost Time (s)		4.6			4.6		4.6	4.6		4.6	4.6	
Lead/Lag							Lead	Lag		Lead	Lag	
Lead-Lag Optimize?							Yes	Yes		Yes	Yes	
Vehicle Extension (s)	3.0	3.0		3.0	3.0		3.0	3.0		3.0	3.0	
Recall Mode	None	None		None	None		None	Max		None	Max	
Walk Time (s)	6.0	6.0		6.0	6.0			7.0			7.0	
Flash Dont Walk (s)	4.5	4.5		4.5	4.5			11.0			11.0	
Pedestrian Calls (#/hr)	16	16		6	6			20			4	
Act Effect Green (s)		10.1			10.1			36.6		41.0	42.1	
Actuated g/C Ratio		0.18			0.18			0.64		0.72	0.74	
v/c Ratio		0.28			0.41			0.51		0.11	0.58	
Control Delay		24.6			13.7			10.9		3.8	7.4	
Queue Delay		0.0			0.0			0.0		0.0	0.0	
Total Delay		24.6			13.7			10.9		3.8	7.4	
LOS		C			B			B		A	A	
Approach Delay		24.6			13.7			10.9			7.1	
Approach LOS		C			B			B			A	

Intersection Summary

Area Type: Other  
 Cycle Length: 60  
 Actuated Cycle Length: 57.1  
 Natural Cycle: 60  
 Control Type: Semi Act-Uncoord  
 Maximum v/c Ratio: 0.58  
 Intersection Signal Delay: 9.7  
 Intersection LOS: A  
 Intersection Capacity Utilization 56.8%  
 ICU Level of Service B  
 Analysis Period (min) 15

Splits and Phases: 30: Wilson Street & Leslie Street/Isabella Street

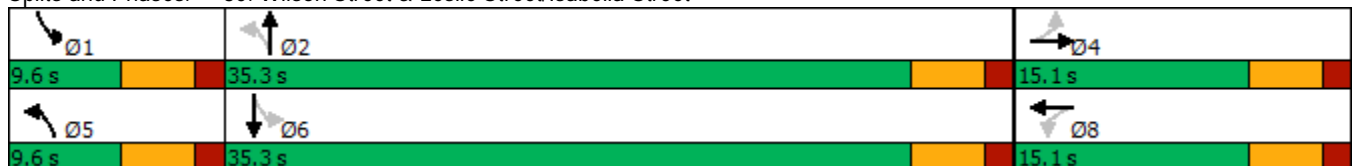

HCM 6th AWSC  
7: Drummond Street & North Street

Horizon Year 2035

Intersection	
Intersection Delay, s/veh	40.9
Intersection LOS	E

Movement	EBL	EBT	EBR	WBL	WBT	WBR	NBL	NBT	NBR	SBL	SBT	SBR
Lane Configurations		↕			↕			↕			↕	
Traffic Vol, veh/h	13	106	13	59	104	110	4	251	42	119	282	20
Future Vol, veh/h	13	106	13	59	104	110	4	251	42	119	282	20
Peak Hour Factor	0.67	0.67	0.67	0.88	0.88	0.88	0.90	0.90	0.90	0.78	0.78	0.78
Heavy Vehicles, %	0	16	0	0	14	0	0	2	3	1	3	7
Mvmt Flow	19	158	19	67	118	125	4	279	47	153	362	26
Number of Lanes	0	1	0	0	1	0	0	1	0	0	1	0

Approach	EB	WB	NB	SB
Opposing Approach	WB	EB	SB	NB
Opposing Lanes	1	1	1	1
Conflicting Approach Left	SB	NB	EB	WB
Conflicting Lanes Left	1	1	1	1
Conflicting Approach Right	NB	SB	WB	EB
Conflicting Lanes Right	1	1	1	1
HCM Control Delay	16.9	22.1	22.7	71.6
HCM LOS	C	C	C	F

Lane	NBLn1	EBLn1	WBLn1	SBLn1
Vol Left, %	1%	10%	22%	28%
Vol Thru, %	85%	80%	38%	67%
Vol Right, %	14%	10%	40%	5%
Sign Control	Stop	Stop	Stop	Stop
Traffic Vol by Lane	297	132	273	421
LT Vol	4	13	59	119
Through Vol	251	106	104	282
RT Vol	42	13	110	20
Lane Flow Rate	330	197	310	540
Geometry Grp	1	1	1	1
Degree of Util (X)	0.649	0.427	0.625	1.024
Departure Headway (Hd)	7.277	8.054	7.454	6.828
Convergence, Y/N	Yes	Yes	Yes	Yes
Cap	498	449	487	534
Service Time	5.277	6.054	5.454	4.828
HCM Lane V/C Ratio	0.663	0.439	0.637	1.011
HCM Control Delay	22.7	16.9	22.1	71.6
HCM Lane LOS	C	C	C	F
HCM 95th-tile Q	4.6	2.1	4.2	15

HCM 6th TWSC  
 3: Drummond Concession 2 & Perthmore

Horizon Year 2035

Intersection						
Int Delay, s/veh	1.3					
Movement	EBL	EBT	WBT	WBR	SBL	SBR
Lane Configurations		↕	↑	↗	↘	
Traffic Vol, veh/h	18	144	220	6	12	25
Future Vol, veh/h	18	144	220	6	12	25
Conflicting Peds, #/hr	0	0	0	0	0	0
Sign Control	Free	Free	Free	Free	Stop	Stop
RT Channelized	-	None	-	None	-	None
Storage Length	-	-	-	250	0	-
Veh in Median Storage, #	-	0	0	-	0	-
Grade, %	-	0	0	-	0	-
Peak Hour Factor	83	83	84	84	78	78
Heavy Vehicles, %	50	9	1	25	0	12
Mvmt Flow	22	173	262	7	15	32

Major/Minor	Major1	Major2	Minor2		
Conflicting Flow All	269	0	0	479	262
Stage 1	-	-	-	262	-
Stage 2	-	-	-	217	-
Critical Hdwy	4.6	-	-	6.4	6.32
Critical Hdwy Stg 1	-	-	-	5.4	-
Critical Hdwy Stg 2	-	-	-	5.4	-
Follow-up Hdwy	2.65	-	-	3.5	3.408
Pot Cap-1 Maneuver	1062	-	-	549	753
Stage 1	-	-	-	786	-
Stage 2	-	-	-	824	-
Platoon blocked, %	-	-	-	-	-
Mov Cap-1 Maneuver	1062	-	-	536	753
Mov Cap-2 Maneuver	-	-	-	536	-
Stage 1	-	-	-	768	-
Stage 2	-	-	-	824	-

Approach	EB	WB	SB
HCM Control Delay, s	0.9	0	10.8
HCM LOS			B

Minor Lane/Major Mvmt	EBL	EBT	WBT	WBR	SBLn1
Capacity (veh/h)	1062	-	-	-	666
HCM Lane V/C Ratio	0.02	-	-	-	0.071
HCM Control Delay (s)	8.5	0	-	-	10.8
HCM Lane LOS	A	A	-	-	B
HCM 95th %tile Q(veh)	0.1	-	-	-	0.2

**Intersection**

Int Delay, s/veh 5.9

**Movement** EBT EBR WBL WBT NBL NBR

Lane Configurations						
Traffic Vol, veh/h	70	103	17	54	88	19
Future Vol, veh/h	70	103	17	54	88	19
Conflicting Peds, #/hr	0	0	0	0	0	28
Sign Control	Free	Free	Free	Free	Stop	Stop
RT Channelized	-	None	-	None	-	None
Storage Length	-	-	-	-	0	-
Veh in Median Storage, #	0	-	-	0	0	-
Grade, %	0	-	-	0	0	-
Peak Hour Factor	63	63	68	68	41	41
Heavy Vehicles, %	2	25	17	8	3	15
Mvmt Flow	111	163	25	79	215	46

**Major/Minor** Major1 Major2 Minor1

Conflicting Flow All	0	0	274	0	322	221
Stage 1	-	-	-	-	193	-
Stage 2	-	-	-	-	129	-
Critical Hdwy	-	-	4.27	-	6.43	6.35
Critical Hdwy Stg 1	-	-	-	-	5.43	-
Critical Hdwy Stg 2	-	-	-	-	5.43	-
Follow-up Hdwy	-	-	2.353	-	3.527	3.435
Pot Cap-1 Maneuver	-	-	1207	-	670	787
Stage 1	-	-	-	-	837	-
Stage 2	-	-	-	-	894	-
Platoon blocked, %	-	-	-	-	-	-
Mov Cap-1 Maneuver	-	-	1207	-	655	768
Mov Cap-2 Maneuver	-	-	-	-	655	-
Stage 1	-	-	-	-	837	-
Stage 2	-	-	-	-	874	-

**Approach** EB WB NB

HCM Control Delay, s	0	1.9	13.7
HCM LOS			B

**Minor Lane/Major Mvmt** NBLn1 EBT EBR WBL WBT

Capacity (veh/h)	673	-	-	1207	-
HCM Lane V/C Ratio	0.388	-	-	0.021	-
HCM Control Delay (s)	13.7	-	-	8	0
HCM Lane LOS	B	-	-	A	A
HCM 95th %tile Q(veh)	1.8	-	-	0.1	-

HCM 6th TWSC  
 34: Wilson Street & North Street

Horizon Year 2035

Intersection												
Int Delay, s/veh	3.8											
Movement	EBL	EBT	EBR	WBL	WBT	WBR	NBL	NBT	NBR	SBL	SBT	SBR
Lane Configurations		↕			↕			↕			↕	
Traffic Vol, veh/h	7	6	12	7	4	83	7	410	12	91	498	23
Future Vol, veh/h	7	6	12	7	4	83	7	410	12	91	498	23
Conflicting Peds, #/hr	3	0	3	3	0	3	13	0	10	10	0	13
Sign Control	Stop	Stop	Stop	Stop	Stop	Stop	Free	Free	Free	Free	Free	Free
RT Channelized	-	-	None	-	-	None	-	-	None	-	-	None
Storage Length	-	-	-	-	-	-	-	-	-	-	-	650
Veh in Median Storage, #	-	0	-	-	0	-	-	0	-	-	0	-
Grade, %	-	0	-	-	0	-	-	0	-	-	0	-
Peak Hour Factor	71	71	71	77	77	77	89	89	89	79	79	79
Heavy Vehicles, %	20	0	0	0	0	28	0	6	0	29	2	25
Mvmt Flow	10	8	17	9	5	108	8	461	13	115	630	29

Major/Minor	Minor2		Minor1		Major1			Major2				
Conflicting Flow All	1431	1388	346	1046	1396	481	672	0	0	484	0	0
Stage 1	888	888	-	494	494	-	-	-	-	-	-	-
Stage 2	543	500	-	552	902	-	-	-	-	-	-	-
Critical Hdwy	7.6	6.5	6.9	7.3	6.5	6.62	4.1	-	-	4.535	-	-
Critical Hdwy Stg 1	6.8	5.5	-	6.1	5.5	-	-	-	-	-	-	-
Critical Hdwy Stg 2	6.4	5.5	-	6.5	5.5	-	-	-	-	-	-	-
Follow-up Hdwy	3.69	4	3.3	3.5	4	3.566	2.2	-	-	2.4755	-	-
Pot Cap-1 Maneuver	91	144	656	196	142	524	928	-	-	929	-	-
Stage 1	278	365	-	561	550	-	-	-	-	-	-	-
Stage 2	485	546	-	491	359	-	-	-	-	-	-	-
Platoon blocked, %								-	-	-	-	-
Mov Cap-1 Maneuver	58	112	647	150	110	518	918	-	-	921	-	-
Mov Cap-2 Maneuver	58	112	-	150	110	-	-	-	-	-	-	-
Stage 1	272	289	-	550	539	-	-	-	-	-	-	-
Stage 2	375	535	-	371	285	-	-	-	-	-	-	-

Approach	EB		WB		NB			SB		
HCM Control Delay, s	42.7		18.6		0.1			2		
HCM LOS	E		C							

Minor Lane/Major Mvmt	NBL	NBT	NBR	EBLn1WBLn1	SBL	SBT	SBR
Capacity (veh/h)	918	-	-	130	386	921	-
HCM Lane V/C Ratio	0.009	-	-	0.271	0.316	0.125	-
HCM Control Delay (s)	9	0	-	42.7	18.6	9.5	0.7
HCM Lane LOS	A	A	-	E	C	A	A
HCM 95th %tile Q(veh)	0	-	-	1	1.3	0.4	-



Perthmore Subdivision TIS  
 12: Wilson Street /Canadian tire Ent/Ext & HWY 7

Background 2035  
 PM Peak Hour



Lane Group	EBL	EBT	EBR	WBL	WBT	WBR	NBL	NBT	NBR	SBL	SBT	SBR
Lane Configurations		↕↕			↕↕			↕	↗		↕	↗
Traffic Volume (vph)	62	834	139	135	770	10	222	32	216	70	29	116
Future Volume (vph)	62	834	139	135	770	10	222	32	216	70	29	116
Ideal Flow (vphpl)	1900	1900	1900	1900	1900	1900	1900	1900	1900	1900	1900	1900
Storage Length (m)	0.0		0.0	0.0		0.0	0.0		60.0	30.0		0.0
Storage Lanes	0		0	0		0	0		1	1		1
Taper Length (m)	7.5			7.5			7.5			10.0		
Lane Util. Factor	0.95	0.95	0.95	0.95	0.95	0.95	1.00	1.00	1.00	1.00	1.00	1.00
Ped Bike Factor								1.00				0.98
Frt		0.980			0.998				0.850			0.850
Flt Protected		0.997			0.993			0.958			0.966	
Satd. Flow (prot)	0	3399	0	0	3419	0	0	1759	1509	0	1835	1615
Flt Permitted		0.757			0.512			0.620			0.584	
Satd. Flow (perm)	0	2581	0	0	1763	0	0	1136	1509	0	1110	1590
Right Turn on Red			Yes			Yes			Yes			Yes
Satd. Flow (RTOR)		16			1				309			125
Link Speed (k/h)		60			60			50			50	
Link Distance (m)		455.2			323.0			476.5			562.7	
Travel Time (s)		27.3			19.4			34.3			40.5	
Confl. Peds. (#/hr)							3					3
Peak Hour Factor	0.82	0.82	0.82	0.87	0.87	0.87	0.70	0.70	0.70	0.93	0.93	0.93
Heavy Vehicles (%)	0%	4%	4%	3%	5%	0%	4%	0%	7%	0%	0%	0%
Adj. Flow (vph)	76	1017	170	155	885	11	317	46	309	75	31	125
Shared Lane Traffic (%)												
Lane Group Flow (vph)	0	1263	0	0	1051	0	0	363	309	0	106	125
Enter Blocked Intersection	No	No	No	No	No	No	No	No	No	No	No	No
Lane Alignment	Left	Left	Right	Left	Left	Right	Left	Left	Right	Left	Left	Right
Median Width(m)		0.0			0.0			0.0			0.0	
Link Offset(m)		0.0			0.0			0.0			0.0	
Crosswalk Width(m)		4.8			4.8			4.8			4.8	
Two way Left Turn Lane												
Headway Factor	1.00	1.00	1.00	1.00	1.00	1.00	1.00	1.00	1.00	1.00	1.00	1.00
Turning Speed (k/h)	25		15	25		15	25		15	25		15
Number of Detectors	1	2		1	2		1	1	1	1	1	1
Detector Template	Left			Left			Left			Left		
Leading Detector (m)	2.0	98.8		2.0	91.8		2.0	9.0	9.0	2.0	9.0	9.0
Trailing Detector (m)	0.0	-3.0		0.0	-3.0		0.0	-3.0	-3.0	0.0	-0.2	-3.0
Detector 1 Position(m)	0.0	-3.0		0.0	-3.0		0.0	-3.0	-3.0	0.0	-0.2	-3.0
Detector 1 Size(m)	2.0	12.0		2.0	12.0		2.0	12.0	12.0	2.0	9.2	12.0
Detector 1 Type	Cl+Ex	Cl+Ex		Cl+Ex	Cl+Ex		Cl+Ex	Cl+Ex	Cl+Ex	Cl+Ex	Cl+Ex	Cl+Ex
Detector 1 Channel												
Detector 1 Extend (s)	0.0	0.0		0.0	0.0		0.0	0.0	0.0	0.0	0.0	0.0
Detector 1 Queue (s)	0.0	0.0		0.0	0.0		0.0	0.0	0.0	0.0	0.0	0.0
Detector 1 Delay (s)	0.0	0.0		0.0	0.0		0.0	0.0	0.0	0.0	0.0	0.0
Detector 2 Position(m)		97.0			90.0							
Detector 2 Size(m)		1.8			1.8							
Detector 2 Type		Cl+Ex			Cl+Ex							
Detector 2 Channel												
Detector 2 Extend (s)		0.0			0.0							

Perthmore Subdivision TIS  
 12: Wilson Street /Canadian tire Ent/Ext & HWY 7

Background 2035  
 PM Peak Hour



Lane Group	EBL	EBT	EBR	WBL	WBT	WBR	NBL	NBT	NBR	SBL	SBT	SBR
Turn Type	Perm	NA		pm+pt	NA		pm+pt	NA	Perm	Perm	NA	Perm
Protected Phases		2		1	6		3	8			4	
Permitted Phases	2			6			8		8	4		4
Detector Phase	2	2		1	1 6		3	3 8	8	4	4	4
Switch Phase												
Minimum Initial (s)	20.0	20.0		7.0	20.0		7.0	10.0	10.0	10.0	10.0	10.0
Minimum Split (s)	43.9	43.9		9.0	43.9		9.0	37.4	37.4	37.4	37.4	37.4
Total Split (s)	43.9	43.9		16.0	59.9		16.0	53.4	53.4	37.4	37.4	37.4
Total Split (%)	38.7%	38.7%		14.1%	52.9%		14.1%	47.1%	47.1%	33.0%	33.0%	33.0%
Maximum Green (s)	37.0	37.0		14.0	53.0		14.0	47.0	47.0	31.0	31.0	31.0
Yellow Time (s)	5.0	5.0		2.0	5.0		2.0	4.1	4.1	4.1	4.1	4.1
All-Red Time (s)	1.9	1.9		0.0	1.9		0.0	2.3	2.3	2.3	2.3	2.3
Lost Time Adjust (s)		0.0			0.0			0.0	0.0		0.0	0.0
Total Lost Time (s)		6.9			6.9			6.4	6.4		6.4	6.4
Lead/Lag	Lag	Lag		Lead			Lead			Lag	Lag	Lag
Lead-Lag Optimize?	Yes	Yes		Yes			Yes			Yes	Yes	Yes
Vehicle Extension (s)	4.5	4.5		2.0	4.5		2.0	3.0	3.0	3.0	3.0	3.0
Recall Mode	Min	Min		None	Min		None	None	None	None	None	None
Walk Time (s)	7.0	7.0			7.0			7.0	7.0	7.0	7.0	7.0
Flash Dont Walk (s)	30.0	30.0			30.0			24.0	24.0	24.0	24.0	24.0
Pedestrian Calls (#/hr)	0	0			0			3	3	0	0	0
Act Effct Green (s)		37.2			53.3			36.8	36.8		20.7	20.7
Actuated g/C Ratio		0.36			0.51			0.36	0.36		0.20	0.20
v/c Ratio		1.35			1.00			0.79	0.42		0.48	0.30
Control Delay		192.3			51.4			40.9	4.3		43.1	7.7
Queue Delay		0.0			0.0			0.0	0.0		0.0	0.0
Total Delay		192.3			51.4			40.9	4.3		43.1	7.7
LOS		F			D			D	A		D	A
Approach Delay		192.3			51.4			24.1			23.9	
Approach LOS		F			D			C			C	

Intersection Summary

Area Type: Other  
 Cycle Length: 113.3  
 Actuated Cycle Length: 103.5  
 Natural Cycle: 140  
 Control Type: Semi Act-Uncoord  
 Maximum v/c Ratio: 1.35  
 Intersection Signal Delay: 99.0  
 Intersection LOS: F  
 Intersection Capacity Utilization 92.3%  
 ICU Level of Service F  
 Analysis Period (min) 15

Splits and Phases: 12: Wilson Street /Canadian tire Ent/Ext & HWY 7

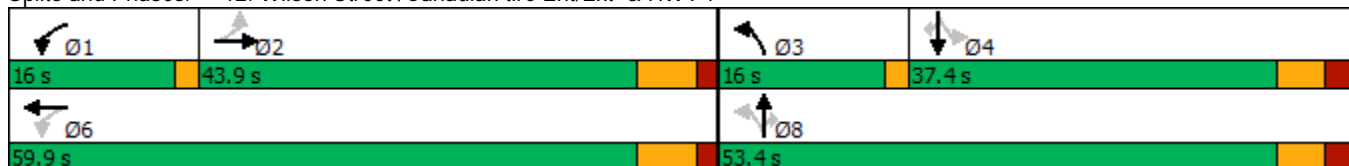

Perthmore Subdivision TIS  
 15: Drummond Street/Dufferin Street & HWY 7

Background 2035  
 PM Peak Hour



Lane Group	EBL	EBT	EBR	WBL	WBT	WBR	NBL	NBT	NBR	SBL	SBT	SBR
Lane Configurations		↕↕			↕↕	↗	↖	↗	↖	↖	↗	↖
Traffic Volume (vph)	78	610	394	155	560	6	293	23	138	16	28	78
Future Volume (vph)	78	610	394	155	560	6	293	23	138	16	28	78
Ideal Flow (vphpl)	1900	1900	1900	1900	1900	1900	1900	1900	1900	1900	1900	1900
Storage Length (m)	0.0		0.0	0.0		15.0	65.0		0.0	40.0		0.0
Storage Lanes	0		0	0		1	1		0	1		0
Taper Length (m)	7.5			7.5			0.0			20.0		
Lane Util. Factor	0.95	0.95	0.95	0.95	0.95	1.00	1.00	1.00	1.00	1.00	1.00	1.00
Ped Bike Factor							1.00	0.99		1.00	0.99	
Frt		0.945				0.850		0.871			0.889	
Flt Protected		0.996			0.989		0.950			0.950		
Satd. Flow (prot)	0	3264	0	0	3436	1615	1787	1606	0	1805	1648	0
Flt Permitted		0.798			0.512		0.669			0.619		
Satd. Flow (perm)	0	2615	0	0	1779	1615	1257	1606	0	1174	1648	0
Right Turn on Red			Yes			Yes			Yes			Yes
Satd. Flow (RTOR)		148				37		157			101	
Link Speed (k/h)		60			60			50			50	
Link Distance (m)		323.0			142.0			376.3			222.4	
Travel Time (s)		19.4			8.5			27.1			16.0	
Confl. Peds. (#/hr)							2		3	3		2
Peak Hour Factor	0.81	0.81	0.81	0.94	0.94	0.94	0.88	0.88	0.88	0.77	0.77	0.77
Heavy Vehicles (%)	2%	7%	0%	0%	5%	0%	1%	0%	2%	0%	0%	2%
Adj. Flow (vph)	96	753	486	165	596	6	333	26	157	21	36	101
Shared Lane Traffic (%)												
Lane Group Flow (vph)	0	1335	0	0	761	6	333	183	0	21	137	0
Enter Blocked Intersection	No	No	No	No	No	No	No	No	No	No	No	No
Lane Alignment	Left	Left	Right	Left	Left	Right	Left	Left	Right	Left	Left	Right
Median Width(m)		0.0			0.0			3.6			3.6	
Link Offset(m)		0.0			0.0			0.0			0.0	
Crosswalk Width(m)		4.8			4.8			4.8			4.8	
Two way Left Turn Lane												
Headway Factor	1.00	1.00	1.00	1.00	1.00	1.00	1.00	1.00	1.00	1.00	1.00	1.00
Turning Speed (k/h)	25		15	25		15	25		15	25		15
Number of Detectors	1	1		1	2	0	1	1		1	1	
Detector Template	Left			Left		Right						
Leading Detector (m)	2.0	94.8		2.0	86.8	0.0	9.0	9.0		9.0	9.0	
Trailing Detector (m)	0.0	93.0		0.0	-1.0	0.0	-3.0	-3.0		-3.0	-3.0	
Detector 1 Position(m)	0.0	93.0		0.0	-1.0	0.0	-3.0	-3.0		-3.0	-3.0	
Detector 1 Size(m)	2.0	1.8		2.0	12.0	2.0	12.0	12.0		12.0	12.0	
Detector 1 Type	Cl+Ex	Cl+Ex		Cl+Ex	Cl+Ex	Cl+Ex	Cl+Ex	Cl+Ex		Cl+Ex	Cl+Ex	
Detector 1 Channel												
Detector 1 Extend (s)	0.0	0.0		0.0	0.0	0.0	0.0	0.0		0.0	0.0	
Detector 1 Queue (s)	0.0	0.0		0.0	0.0	0.0	0.0	0.0		0.0	0.0	
Detector 1 Delay (s)	0.0	0.0		0.0	0.0	0.0	0.0	0.0		0.0	0.0	
Detector 2 Position(m)					85.0							
Detector 2 Size(m)					1.8							
Detector 2 Type					Cl+Ex							
Detector 2 Channel												
Detector 2 Extend (s)					0.0							

Perthmore Subdivision TIS  
 15: Drummond Street/Dufferin Street & HWY 7

Background 2035  
 PM Peak Hour



Lane Group	EBL	EBT	EBR	WBL	WBT	WBR	NBL	NBT	NBR	SBL	SBT	SBR
Turn Type	Perm	NA		pm+pt	NA	Perm	Perm	NA		Perm	NA	
Protected Phases		2		1	6			8				4
Permitted Phases	2			6		6	8			4		
Detector Phase	2	2		1	1 6	6	8	8		4		4
Switch Phase												
Minimum Initial (s)	20.0	20.0		7.0	20.0	20.0	10.0	10.0		10.0		10.0
Minimum Split (s)	33.3	33.3		10.0	36.3	36.3	38.3	38.3		38.3		38.3
Total Split (s)	46.3	46.3		10.0	59.3	59.3	38.3	38.3		38.3		38.3
Total Split (%)	47.4%	47.4%		10.2%	60.8%	60.8%	39.2%	39.2%		39.2%		39.2%
Maximum Green (s)	40.0	40.0		7.0	53.0	53.0	32.0	32.0		32.0		32.0
Yellow Time (s)	5.0	5.0		3.0	5.0	5.0	4.1	4.1		4.1		4.1
All-Red Time (s)	1.3	1.3		0.0	1.3	1.3	2.2	2.2		2.2		2.2
Lost Time Adjust (s)		0.0			0.0	0.0	0.0	0.0		0.0		0.0
Total Lost Time (s)		6.3			6.3	6.3	6.3	6.3		6.3		6.3
Lead/Lag	Lag	Lag		Lead								
Lead-Lag Optimize?	Yes	Yes		Yes								
Vehicle Extension (s)	4.6	4.6		3.0	4.6	4.6	3.0	3.0		3.0		3.0
Recall Mode	Min	Min		None	Min	Min	None	None		None		None
Walk Time (s)	7.0	7.0			7.0	7.0	7.0	7.0		7.0		7.0
Flash Dont Walk (s)	20.0	20.0			20.0	20.0	25.0	25.0		25.0		25.0
Pedestrian Calls (#/hr)	0	0			0	0	2	2		0		0
Act Effct Green (s)		41.9			52.0	52.0	27.8	27.8		27.8		27.8
Actuated g/C Ratio		0.45			0.56	0.56	0.30	0.30		0.30		0.30
v/c Ratio		1.05			1.03dl	0.01	0.88	0.31		0.06		0.24
Control Delay		65.4			19.0	0.0	56.1	7.3		23.2		9.2
Queue Delay		0.0			0.0	0.0	0.0	0.0		0.0		0.0
Total Delay		65.4			19.0	0.0	56.1	7.3		23.2		9.2
LOS		E			B	A	E	A		C		A
Approach Delay		65.4			18.9			38.8				11.1
Approach LOS		E			B			D				B

Intersection Summary

Area Type: Other  
 Cycle Length: 97.6  
 Actuated Cycle Length: 92.5  
 Natural Cycle: 115  
 Control Type: Semi Act-Uncoord  
 Maximum v/c Ratio: 1.05  
 Intersection Signal Delay: 44.5  
 Intersection LOS: D  
 Intersection Capacity Utilization 90.7%  
 ICU Level of Service E  
 Analysis Period (min) 15  
 dl Defacto Left Lane. Recode with 1 though lane as a left lane.

Splits and Phases: 15: Drummond Street/Dufferin Street & HWY 7

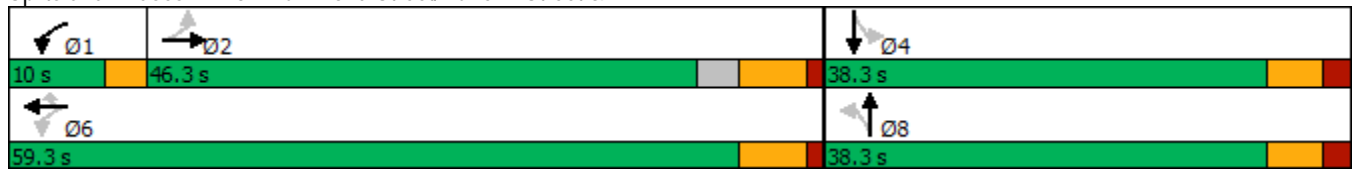

Perthmore Subdivision TIS  
 26: Wilson Street & Sunset Boulevard

Background 2035  
 PM Peak Hour



Lane Group	EBL	EBT	EBR	WBL	WBT	WBR	NBL	NBT	NBR	SBL	SBT	SBR
Lane Configurations		↖	↗		↔		↖	↗		↖	↗	↗
Traffic Volume (vph)	164	36	272	12	59	36	123	770	6	17	798	78
Future Volume (vph)	164	36	272	12	59	36	123	770	6	17	798	78
Ideal Flow (vphpl)	1900	1900	1900	1900	1900	1900	1900	1900	1900	1900	1900	1900
Storage Length (m)	0.0		0.0	0.0		0.0	15.0		0.0	25.0		0.0
Storage Lanes	0		1	0		0	1		0	1		1
Taper Length (m)	7.5			7.5			7.5			7.5		
Lane Util. Factor	1.00	1.00	1.00	1.00	1.00	1.00	1.00	1.00	1.00	1.00	1.00	1.00
Ped Bike Factor		0.97	0.94		0.98			1.00				0.91
Frt			0.850		0.955			0.999				0.850
Flt Protected		0.961			0.994		0.950			0.950		
Satd. Flow (prot)	0	1728	1583	0	1747	0	1770	1842	0	1805	1863	1615
Flt Permitted		0.711			0.952		0.137			0.153		
Satd. Flow (perm)	0	1243	1492	0	1668	0	255	1842	0	291	1863	1464
Right Turn on Red			Yes			Yes			Yes			Yes
Satd. Flow (RTOR)			216		43			1				113
Link Speed (k/h)		50			50			50				50
Link Distance (m)		238.8			244.8			341.7				186.3
Travel Time (s)		17.2			17.6			24.6				13.4
Confl. Peds. (#/hr)	26		23	23		26	45		20	20		45
Peak Hour Factor	0.93	0.93	0.93	0.77	0.77	0.77	0.87	0.87	0.87	0.83	0.83	0.83
Heavy Vehicles (%)	6%	4%	2%	0%	2%	0%	2%	3%	0%	0%	2%	0%
Adj. Flow (vph)	176	39	292	16	77	47	141	885	7	20	961	94
Shared Lane Traffic (%)												
Lane Group Flow (vph)	0	215	292	0	140	0	141	892	0	20	961	94
Enter Blocked Intersection	No	No	No	No	No	No	No	No	No	No	No	No
Lane Alignment	Left	Left	Right	Left	Left	Right	Left	Left	Right	Left	Left	Right
Median Width(m)		0.0			0.0			3.6			3.6	
Link Offset(m)		0.0			0.0			0.0			0.0	
Crosswalk Width(m)		4.8			4.8			4.8			4.8	
Two way Left Turn Lane												
Headway Factor	1.00	1.00	1.00	1.00	1.00	1.00	1.00	1.00	1.00	1.00	1.00	1.00
Turning Speed (k/h)	25		15	25		15	25		15	25		15
Number of Detectors	1	1	1	1	2		1	2		1	2	1
Detector Template	Left		Right	Left	Thru			Thru			Thru	Right
Leading Detector (m)	2.0	10.0	2.0	2.0	10.0		3.0	10.0		3.0	10.0	2.0
Trailing Detector (m)	0.0	5.0	0.0	0.0	0.0		-1.0	0.0		-1.0	0.0	0.0
Detector 1 Position(m)	0.0	5.0	0.0	0.0	0.0		-1.0	0.0		-1.0	0.0	0.0
Detector 1 Size(m)	2.0	5.0	2.0	2.0	0.6		4.0	0.6		4.0	0.6	2.0
Detector 1 Type	Cl+Ex	Cl+Ex	Cl+Ex	Cl+Ex	Cl+Ex		Cl+Ex	Cl+Ex		Cl+Ex	Cl+Ex	Cl+Ex
Detector 1 Channel												
Detector 1 Extend (s)	0.0	0.0	0.0	0.0	0.0		0.0	0.0		0.0	0.0	0.0
Detector 1 Queue (s)	0.0	0.0	0.0	0.0	0.0		0.0	0.0		0.0	0.0	0.0
Detector 1 Delay (s)	0.0	0.0	0.0	0.0	0.0		0.0	0.0		0.0	0.0	0.0
Detector 2 Position(m)					9.4			9.4			9.4	
Detector 2 Size(m)					0.6			0.6			0.6	
Detector 2 Type					Cl+Ex			Cl+Ex			Cl+Ex	
Detector 2 Channel												
Detector 2 Extend (s)					0.0			0.0			0.0	

Perthmore Subdivision TIS  
26: Wilson Street & Sunset Boulevard

Background 2035  
PM Peak Hour



Lane Group	EBL	EBT	EBR	WBL	WBT	WBR	NBL	NBT	NBR	SBL	SBT	SBR
Turn Type	Perm	NA	Perm	Perm	NA		pm+pt	NA		pm+pt	NA	Perm
Protected Phases		4			8		5	2		1	6	
Permitted Phases	4		4	8			2			6		6
Detector Phase	4	4	4	8	8		5	2		1	6	6
Switch Phase							2			6		
Minimum Initial (s)	10.0	10.0	10.0	10.0	10.0		5.0	10.0		5.0	10.0	10.0
Minimum Split (s)	22.6	22.6	22.6	22.6	22.6		9.6	22.6		9.6	22.6	22.6
Total Split (s)	22.6	22.6	22.6	22.6	22.6		9.6	27.8		9.6	27.8	27.8
Total Split (%)	37.7%	37.7%	37.7%	37.7%	37.7%		16.0%	46.3%		16.0%	46.3%	46.3%
Maximum Green (s)	18.0	18.0	18.0	18.0	18.0		5.0	23.2		5.0	23.2	23.2
Yellow Time (s)	3.3	3.3	3.3	3.3	3.3		3.3	3.3		3.3	3.3	3.3
All-Red Time (s)	1.3	1.3	1.3	1.3	1.3		1.3	1.3		1.3	1.3	1.3
Lost Time Adjust (s)		0.0	0.0		0.0		0.0	0.0		0.0	0.0	0.0
Total Lost Time (s)		4.6	4.6		4.6		4.6	4.6		4.6	4.6	4.6
Lead/Lag							Lead	Lag		Lead	Lag	Lag
Lead-Lag Optimize?							Yes	Yes		Yes	Yes	Yes
Vehicle Extension (s)	3.0	3.0	3.0	3.0	3.0		3.0	3.0		3.0	3.0	3.0
Recall Mode	None	None	None	None	None		None	Min		None	Min	Min
Walk Time (s)	7.0	7.0	7.0	7.0	7.0			7.0			7.0	7.0
Flash Dont Walk (s)	11.0	11.0	11.0	11.0	11.0			11.0			11.0	11.0
Pedestrian Calls (#/hr)	16	16	16	35	35			20			20	20
Act Effct Green (s)		14.2	14.2		14.2		30.1	29.2		27.4	23.6	23.6
Actuated g/C Ratio		0.26	0.26		0.26		0.55	0.54		0.50	0.43	0.43
v/c Ratio		0.66	0.53		0.30		0.50	0.91		0.07	1.19	0.13
Control Delay		29.5	9.4		14.0		14.9	29.8		6.8	120.2	2.9
Queue Delay		0.0	0.0		0.0		0.0	0.0		0.0	0.0	0.0
Total Delay		29.5	9.4		14.0		14.9	29.8		6.8	120.2	2.9
LOS		C	A		B		B	C		A	F	A
Approach Delay		17.9			14.0			27.8			107.8	
Approach LOS		B			B			C			F	

Intersection Summary

Area Type: Other  
 Cycle Length: 60  
 Actuated Cycle Length: 54.5  
 Natural Cycle: 90  
 Control Type: Semi Act-Uncoord  
 Maximum v/c Ratio: 1.19  
 Intersection Signal Delay: 56.5  
 Intersection LOS: E  
 Intersection Capacity Utilization 84.7%  
 ICU Level of Service E  
 Analysis Period (min) 15

Splits and Phases: 26: Wilson Street & Sunset Boulevard

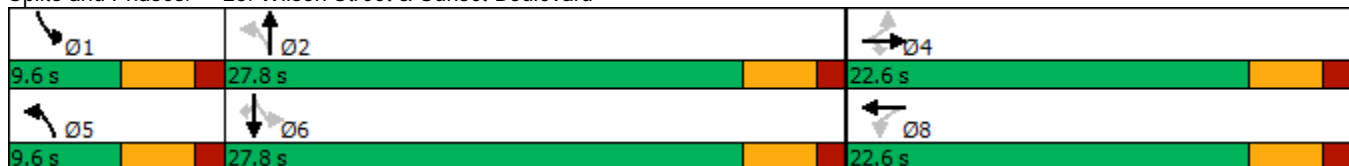

Perthmore Subdivision TIS  
 30: Wilson Street & Leslie Street/Isabella Street

Background 2035  
 PM Peak Hour



Lane Group	EBL	EBT	EBR	WBL	WBT	WBR	NBL	NBT	NBR	SBL	SBT	SBR
Lane Configurations		↕			↕		↗	↘		↗	↘	
Traffic Volume (vph)	146	30	7	38	35	90	3	718	4	46	828	58
Future Volume (vph)	146	30	7	38	35	90	3	718	4	46	828	58
Ideal Flow (vphpl)	1900	1900	1900	1900	1900	1900	1900	1900	1900	1900	1900	1900
Storage Length (m)	0.0		0.0	0.0		0.0	60.0		0.0	25.0		0.0
Storage Lanes	0		0	0		0	1		0	1		0
Taper Length (m)	7.5			7.5			25.0			15.0		
Lane Util. Factor	1.00	1.00	1.00	1.00	1.00	1.00	1.00	1.00	1.00	1.00	1.00	1.00
Ped Bike Factor		0.99			0.98			1.00		1.00	0.99	
Frt		0.995			0.925			0.999			0.990	
Flt Protected		0.962			0.989		0.950			0.950		
Satd. Flow (prot)	0	1772	0	0	1708	0	1805	1843	0	1703	1819	0
Flt Permitted		0.607			0.918		0.121			0.196		
Satd. Flow (perm)	0	1112	0	0	1578	0	230	1843	0	350	1819	0
Right Turn on Red			Yes			Yes			Yes			Yes
Satd. Flow (RTOR)		3			90			1			9	
Link Speed (k/h)		50			50			50			50	
Link Distance (m)		224.9			415.9			340.1			341.7	
Travel Time (s)		16.2			29.9			24.5			24.6	
Confl. Peds. (#/hr)	4		14	14		4	41		10	10		41
Peak Hour Factor	0.76	0.76	0.76	0.90	0.90	0.90	0.96	0.96	0.96	0.85	0.85	0.85
Heavy Vehicles (%)	3%	0%	0%	0%	0%	0%	0%	3%	0%	6%	3%	0%
Adj. Flow (vph)	192	39	9	42	39	100	3	748	4	54	974	68
Shared Lane Traffic (%)												
Lane Group Flow (vph)	0	240	0	0	181	0	3	752	0	54	1042	0
Enter Blocked Intersection	No	No	No	No	No	No	No	No	No	No	No	No
Lane Alignment	Left	Left	Right	Left	Left	Right	Left	Left	Right	Left	Left	Right
Median Width(m)		0.0			0.0			3.6			3.6	
Link Offset(m)		0.0			0.0			0.0			0.0	
Crosswalk Width(m)		4.8			4.8			4.8			4.8	
Two way Left Turn Lane												
Headway Factor	1.00	1.00	1.00	1.00	1.00	1.00	1.00	1.00	1.00	1.00	1.00	1.00
Turning Speed (k/h)	25		15	25		15	25		15	25		15
Number of Detectors	1	2		1	2		1	2		1	2	
Detector Template	Left	Thru		Left	Thru		Left	Thru		Left	Thru	
Leading Detector (m)	2.0	10.0		2.0	10.0		2.0	10.0		2.0	10.0	
Trailing Detector (m)	0.0	0.0		0.0	0.0		0.0	0.0		0.0	0.0	
Detector 1 Position(m)	0.0	0.0		0.0	0.0		0.0	0.0		0.0	0.0	
Detector 1 Size(m)	2.0	0.6		2.0	0.6		2.0	0.6		2.0	0.6	
Detector 1 Type	Cl+Ex	Cl+Ex		Cl+Ex	Cl+Ex		Cl+Ex	Cl+Ex		Cl+Ex	Cl+Ex	
Detector 1 Channel												
Detector 1 Extend (s)	0.0	0.0		0.0	0.0		0.0	0.0		0.0	0.0	
Detector 1 Queue (s)	0.0	0.0		0.0	0.0		0.0	0.0		0.0	0.0	
Detector 1 Delay (s)	0.0	0.0		0.0	0.0		0.0	0.0		0.0	0.0	
Detector 2 Position(m)		9.4			9.4			9.4			9.4	
Detector 2 Size(m)		0.6			0.6			0.6			0.6	
Detector 2 Type		Cl+Ex			Cl+Ex			Cl+Ex			Cl+Ex	
Detector 2 Channel												
Detector 2 Extend (s)		0.0			0.0			0.0			0.0	

Perthmore Subdivision TIS  
 30: Wilson Street & Leslie Street/Isabella Street

Background 2035  
 PM Peak Hour



Lane Group	EBL	EBT	EBR	WBL	WBT	WBR	NBL	NBT	NBR	SBL	SBT	SBR
Turn Type	Perm	NA		Perm	NA		pm+pt	NA		pm+pt	NA	
Protected Phases		4			8		5	2		1	6	
Permitted Phases	4			8			2			6		
Detector Phase	4	4		8	8		5	2		1	6	
Switch Phase							2			6		
Minimum Initial (s)	10.0	10.0		10.0	10.0		5.0	10.0		5.0	10.0	
Minimum Split (s)	15.0	15.0		15.0	15.0		9.6	35.0		9.6	35.0	
Total Split (s)	15.0	15.0		15.0	15.0		9.6	35.4		9.6	35.4	
Total Split (%)	25.0%	25.0%		25.0%	25.0%		16.0%	59.0%		16.0%	59.0%	
Maximum Green (s)	10.4	10.4		10.4	10.4		5.0	30.8		5.0	30.8	
Yellow Time (s)	3.3	3.3		3.3	3.3		3.3	3.3		3.3	3.3	
All-Red Time (s)	1.3	1.3		1.3	1.3		1.3	1.3		1.3	1.3	
Lost Time Adjust (s)		0.0			0.0		0.0	0.0		0.0	0.0	
Total Lost Time (s)		4.6			4.6		4.6	4.6		4.6	4.6	
Lead/Lag							Lead	Lag		Lead	Lag	
Lead-Lag Optimize?							Yes	Yes		Yes	Yes	
Vehicle Extension (s)	3.0	3.0		3.0	3.0		3.0	3.0		3.0	3.0	
Recall Mode	None	None		None	None		None	Min		None	Min	
Walk Time (s)	5.0	5.0		5.0	5.0			7.0			7.0	
Flash Dont Walk (s)	5.0	5.0		5.0	5.0			11.0			11.0	
Pedestrian Calls (#/hr)	10	10		4	4			14			33	
Act Effect Green (s)		10.4			10.4		34.2	31.3		35.9	35.0	
Actuated g/C Ratio		0.18			0.18		0.61	0.55		0.64	0.62	
v/c Ratio		1.15			0.50		0.01	0.74		0.16	0.92	
Control Delay		139.8			17.3		3.3	16.8		4.5	26.7	
Queue Delay		0.0			0.0		0.0	0.0		0.0	0.0	
Total Delay		139.8			17.3		3.3	16.8		4.5	26.7	
LOS		F			B		A	B		A	C	
Approach Delay		139.8			17.3			16.7			25.6	
Approach LOS		F			B			B			C	

Intersection Summary

Area Type: Other  
 Cycle Length: 60  
 Actuated Cycle Length: 56.5  
 Natural Cycle: 100  
 Control Type: Semi Act-Uncoord  
 Maximum v/c Ratio: 1.15  
 Intersection Signal Delay: 34.1  
 Intersection LOS: C  
 Intersection Capacity Utilization 78.7%  
 ICU Level of Service D  
 Analysis Period (min) 15

Splits and Phases: 30: Wilson Street & Leslie Street/Isabella Street

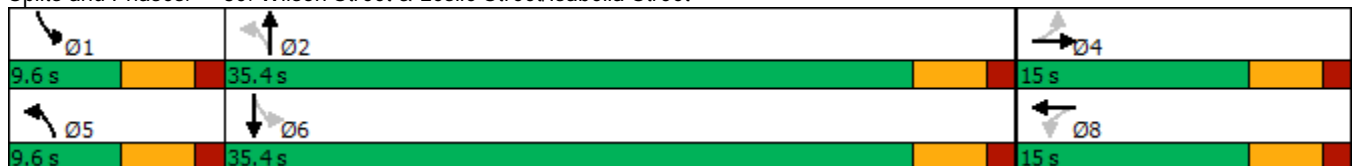



HCM 6th TWSC  
 3: Drummond Concession 2 & Perthmore

Horizon Year 2035

Intersection						
Int Delay, s/veh	1.3					
Movement	EBL	EBT	WBT	WBR	SBL	SBR
Lane Configurations		↕	↑	↗	↘	
Traffic Vol, veh/h	30	269	197	24	6	34
Future Vol, veh/h	30	269	197	24	6	34
Conflicting Peds, #/hr	0	0	0	0	0	0
Sign Control	Free	Free	Free	Free	Stop	Stop
RT Channelized	-	None	-	None	-	None
Storage Length	-	-	-	250	0	-
Veh in Median Storage, #	-	0	0	-	0	-
Grade, %	-	0	0	-	0	-
Peak Hour Factor	85	85	83	83	68	68
Heavy Vehicles, %	20	2	0	0	25	0
Mvmt Flow	35	316	237	29	9	50

Major/Minor	Major1	Major2	Minor2		
Conflicting Flow All	266	0	0	623	237
Stage 1	-	-	-	237	-
Stage 2	-	-	-	386	-
Critical Hdwy	4.3	-	-	6.65	6.2
Critical Hdwy Stg 1	-	-	-	5.65	-
Critical Hdwy Stg 2	-	-	-	5.65	-
Follow-up Hdwy	2.38	-	-	3.725	3.3
Pot Cap-1 Maneuver	1201	-	-	415	807
Stage 1	-	-	-	751	-
Stage 2	-	-	-	640	-
Platoon blocked, %	-	-	-	-	-
Mov Cap-1 Maneuver	1201	-	-	400	807
Mov Cap-2 Maneuver	-	-	-	400	-
Stage 1	-	-	-	725	-
Stage 2	-	-	-	640	-

Approach	EB	WB	SB
HCM Control Delay, s	0.8	0	10.6
HCM LOS			B

Minor Lane/Major Mvmt	EBL	EBT	WBT	WBR	SBLn1
Capacity (veh/h)	1201	-	-	-	700
HCM Lane V/C Ratio	0.029	-	-	-	0.084
HCM Control Delay (s)	8.1	0	-	-	10.6
HCM Lane LOS	A	A	-	-	B
HCM 95th %tile Q(veh)	0.1	-	-	-	0.3

HCM 6th TWSC  
21: Victoria Street & Isabella Street

Horizon Year 2035

Intersection						
Int Delay, s/veh	1.7					
Movement	EBT	EBR	WBL	WBT	NBL	NBR
Lane Configurations						
Traffic Vol, veh/h	85	14	20	101	12	14
Future Vol, veh/h	85	14	20	101	12	14
Conflicting Peds, #/hr	0	0	0	0	1	10
Sign Control	Free	Free	Free	Free	Stop	Stop
RT Channelized	-	None	-	None	-	None
Storage Length	-	-	-	-	0	-
Veh in Median Storage, #	0	-	-	0	0	-
Grade, %	0	-	-	0	0	-
Peak Hour Factor	78	78	72	72	75	75
Heavy Vehicles, %	2	0	0	1	0	10
Mvmt Flow	109	18	28	140	16	19

Major/Minor	Major1	Major2	Minor1	Minor2	Minor3
Conflicting Flow All	0	0	127	0	315
Stage 1	-	-	-	-	118
Stage 2	-	-	-	-	197
Critical Hdwy	-	-	4.1	-	6.4
Critical Hdwy Stg 1	-	-	-	-	5.4
Critical Hdwy Stg 2	-	-	-	-	5.4
Follow-up Hdwy	-	-	2.2	-	3.5
Pot Cap-1 Maneuver	-	-	1472	-	682
Stage 1	-	-	-	-	912
Stage 2	-	-	-	-	841
Platoon blocked, %	-	-	-	-	-
Mov Cap-1 Maneuver	-	-	1472	-	667
Mov Cap-2 Maneuver	-	-	-	-	667
Stage 1	-	-	-	-	912
Stage 2	-	-	-	-	822

Approach	EB	WB	NB
HCM Control Delay, s	0	1.2	9.9
HCM LOS			A

Minor Lane/Major Mvmt	NBLn1	EBT	EBR	WBL	WBT
Capacity (veh/h)	772	-	-	1472	-
HCM Lane V/C Ratio	0.045	-	-	0.019	-
HCM Control Delay (s)	9.9	-	-	7.5	0
HCM Lane LOS	A	-	-	A	A
HCM 95th %tile Q(veh)	0.1	-	-	0.1	-

HCM 6th TWSC  
34: Wilson Street & North Street

Horizon Year 2035

Intersection												
Int Delay, s/veh	12.9											
Movement	EBL	EBT	EBR	WBL	WBT	WBR	NBL	NBT	NBR	SBL	SBT	SBR
Lane Configurations		↕			↕			↕			↕	
Traffic Vol, veh/h	7	6	14	13	12	145	13	559	30	162	658	33
Future Vol, veh/h	7	6	14	13	12	145	13	559	30	162	658	33
Conflicting Peds, #/hr	6	0	10	10	0	6	23	0	22	22	0	23
Sign Control	Stop	Stop	Stop	Stop	Stop	Stop	Free	Free	Free	Free	Free	Free
RT Channelized	-	-	None	-	-	None	-	-	None	-	-	None
Storage Length	-	-	-	-	-	-	-	-	-	-	-	650
Veh in Median Storage, #	-	0	-	-	0	-	-	0	-	-	0	-
Grade, %	-	0	-	-	0	-	-	0	-	-	0	-
Peak Hour Factor	68	68	68	94	94	94	89	89	89	96	96	96
Heavy Vehicles, %	20	0	0	0	0	7	0	1	0	12	1	0
Mvmt Flow	10	9	21	14	13	154	15	628	34	169	685	34

Major/Minor	Minor2		Minor1		Major1			Major2				
Conflicting Flow All	1828	1777	393	1392	1777	673	742	0	0	684	0	0
Stage 1	1063	1063	-	697	697	-	-	-	-	-	-	-
Stage 2	765	714	-	695	1080	-	-	-	-	-	-	-
Critical Hdwy	7.6	6.5	6.9	7.3	6.5	6.305	4.1	-	-	4.28	-	-
Critical Hdwy Stg 1	6.8	5.5	-	6.1	5.5	-	-	-	-	-	-	-
Critical Hdwy Stg 2	6.4	5.5	-	6.5	5.5	-	-	-	-	-	-	-
Follow-up Hdwy	3.69	4	3.3	3.5	4.3	3.665	2.2	-	-	2.314	-	-
Pot Cap-1 Maneuver	46	83	612	112	83	443	874	-	-	853	-	-
Stage 1	215	302	-	435	446	-	-	-	-	-	-	-
Stage 2	361	438	-	403	297	-	-	-	-	-	-	-
Platoon blocked, %								-	-	-	-	-
Mov Cap-1 Maneuver	17	51	595	67	51	433	857	-	-	837	-	-
Mov Cap-2 Maneuver	17	51	-	67	51	-	-	-	-	-	-	-
Stage 1	205	196	-	415	425	-	-	-	-	-	-	-
Stage 2	218	418	-	244	192	-	-	-	-	-	-	-

Approach	EB		WB		NB		SB	
HCM Control Delay, s	204.9		67.2		0.2		2.9	
HCM LOS	F		F					

Minor Lane/Major Mvmt	NBL	NBT	NBR	EBLn1WBLn1	SBL	SBT	SBR
Capacity (veh/h)	857	-	-	49	222	837	-
HCM Lane V/C Ratio	0.017	-	-	0.81	0.815	0.202	-
HCM Control Delay (s)	9.3	0	-	204.9	67.2	10.4	1.2
HCM Lane LOS	A	A	-	F	F	B	A
HCM 95th %tile Q(veh)	0.1	-	-	3.3	6.1	0.8	-

HCM 6th AWSC  
7: Drummond Street & North Street

Horizon Year 2035

Intersection	
Intersection Delay, s/veh	97.4
Intersection LOS	F

Movement	EBL	EBT	EBR	WBL	WBT	WBR	NBL	NBT	NBR	SBL	SBT	SBR
Lane Configurations		↕			↕			↕			↕	
Traffic Vol, veh/h	16	107	18	58	110	156	22	364	48	168	330	16
Future Vol, veh/h	16	107	18	58	110	156	22	364	48	168	330	16
Peak Hour Factor	0.85	0.85	0.85	0.85	0.85	0.85	0.89	0.89	0.89	0.85	0.85	0.85
Heavy Vehicles, %	0	6	0	0	5	1	0	0	0	0	0	0
Mvmt Flow	19	126	21	68	129	184	25	409	54	198	388	19
Number of Lanes	0	1	0	0	1	0	0	1	0	0	1	0

Approach	EB	WB	NB	SB
Opposing Approach	WB	EB	SB	NB
Opposing Lanes	1	1	1	1
Conflicting Approach Left	SB	NB	EB	WB
Conflicting Lanes Left	1	1	1	1
Conflicting Approach Right	NB	SB	WB	EB
Conflicting Lanes Right	1	1	1	1
HCM Control Delay	19.9	40.4	76.2	171.6
HCM LOS	C	E	F	F

Lane	NBLn1	EBLn1	WBLn1	SBLn1
Vol Left, %	5%	11%	18%	33%
Vol Thru, %	84%	76%	34%	64%
Vol Right, %	11%	13%	48%	3%
Sign Control	Stop	Stop	Stop	Stop
Traffic Vol by Lane	434	141	324	514
LT Vol	22	16	58	168
Through Vol	364	107	110	330
RT Vol	48	18	156	16
Lane Flow Rate	488	166	381	605
Geometry Grp	1	1	1	1
Degree of Util (X)	1.016	0.414	0.821	1.294
Departure Headway (Hd)	8.224	10.007	8.539	7.859
Convergence, Y/N	Yes	Yes	Yes	Yes
Cap	444	362	427	466
Service Time	6.224	8.007	6.539	5.859
HCM Lane V/C Ratio	1.099	0.459	0.892	1.298
HCM Control Delay	76.2	19.9	40.4	171.6
HCM Lane LOS	F	C	E	F
HCM 95th-tile Q	13.4	2	7.6	25.5

Perthmore Subdivision TIS  
 12: Wilson Street /Canadian tire Ent/Ext & HWY 7

2030 Total Conditions  
 AM Peak Hour



Lane Group	EBL	EBT	EBR	WBL	WBT	WBR	NBL	NBT	NBR	SBL	SBT	SBR
Lane Configurations												
Traffic Volume (vph)	70	486	278	221	609	13	346	70	227	49	69	108
Future Volume (vph)	70	486	278	221	609	13	346	70	227	49	69	108
Ideal Flow (vphpl)	1900	1900	1900	1900	1900	1900	1900	1900	1900	1900	1900	1900
Storage Length (m)	50.0		75.0	40.0		30.0	0.0		0.0	30.0		7.5
Storage Lanes	1		1	1		1	0		1	0		1
Taper Length (m)	7.5			7.5			7.5			10.0		
Lane Util. Factor	1.00	0.95	1.00	1.00	0.95	1.00	1.00	1.00	1.00	1.00	1.00	1.00
Ped Bike Factor									0.99		1.00	
Fr <sub>t</sub>			0.850			0.850			0.850			0.850
Fl <sub>t</sub> Protected	0.950			0.950				0.960			0.980	
Satd. Flow (prot)	1805	3505	1553	1805	3406	1538	0	1765	1509	0	1782	1583
Fl <sub>t</sub> Permitted	0.411			0.373				0.676			0.646	
Satd. Flow (perm)	781	3505	1553	709	3406	1538	0	1243	1490	0	1174	1583
Right Turn on Red			Yes			Yes			Yes			Yes
Satd. Flow (RTOR)			305			59			241			93
Link Speed (k/h)		60			60			50			50	
Link Distance (m)		455.2			323.0			478.4			562.7	
Travel Time (s)		27.3			19.4			34.4			40.5	
Confl. Peds. (#/hr)									1	1		
Peak Hour Factor	0.91	0.91	0.91	0.96	0.96	0.96	0.94	0.94	0.94	0.92	0.92	0.92
Heavy Vehicles (%)	0%	3%	4%	0%	6%	5%	4%	0%	7%	8%	2%	2%
Adj. Flow (vph)	77	534	305	230	634	14	368	74	241	53	75	117
Shared Lane Traffic (%)												
Lane Group Flow (vph)	77	534	305	230	634	14	0	442	241	0	128	117
Enter Blocked Intersection	No	No	No	No	No	No	No	No	No	No	No	No
Lane Alignment	Left	Left	Right	Left	Left	Right	Left	Left	Right	Left	Left	Right
Median Width(m)		3.6			3.6			0.0			0.0	
Link Offset(m)		0.0			0.0			0.0			0.0	
Crosswalk Width(m)		4.8			4.8			4.8			4.8	
Two way Left Turn Lane												
Headway Factor	1.00	1.00	1.00	1.00	1.00	1.00	1.00	1.00	1.00	1.00	1.00	1.00
Turning Speed (k/h)	25		15	25		15	25		15	25		15
Number of Detectors	1	2	1	1	2	1	1	1	1	1	1	1
Detector Template	Left		Right	Left		Right	Left			Left		
Leading Detector (m)	2.0	98.8	2.0	2.0	91.8	2.0	2.0	9.0	9.0	2.0	9.0	9.0
Trailing Detector (m)	0.0	-3.0	0.0	0.0	-3.0	0.0	0.0	-3.0	-3.0	0.0	-0.2	-3.0
Detector 1 Position(m)	0.0	-3.0	0.0	0.0	-3.0	0.0	0.0	-3.0	-3.0	0.0	-0.2	-3.0
Detector 1 Size(m)	2.0	12.0	2.0	2.0	12.0	2.0	2.0	12.0	12.0	2.0	9.2	12.0
Detector 1 Type	Cl+Ex	Cl+Ex	Cl+Ex	Cl+Ex	Cl+Ex	Cl+Ex	Cl+Ex	Cl+Ex	Cl+Ex	Cl+Ex	Cl+Ex	Cl+Ex
Detector 1 Channel												
Detector 1 Extend (s)	0.0	0.0	0.0	0.0	0.0	0.0	0.0	0.0	0.0	0.0	0.0	0.0
Detector 1 Queue (s)	0.0	0.0	0.0	0.0	0.0	0.0	0.0	0.0	0.0	0.0	0.0	0.0
Detector 1 Delay (s)	0.0	0.0	0.0	0.0	0.0	0.0	0.0	0.0	0.0	0.0	0.0	0.0
Detector 2 Position(m)		97.0			90.0							
Detector 2 Size(m)		1.8			1.8							
Detector 2 Type		Cl+Ex			Cl+Ex							
Detector 2 Channel												
Detector 2 Extend (s)		0.0			0.0							

Perthmore Subdivision TIS  
 12: Wilson Street /Canadian tire Ent/Ext & HWY 7

2030 Total Conditions  
 AM Peak Hour



Lane Group	EBL	EBT	EBR	WBL	WBT	WBR	NBL	NBT	NBR	SBL	SBT	SBR
Turn Type	Perm	NA	Perm	pm+pt	NA	Perm	pm+pt	NA	Perm	Perm	NA	Perm
Protected Phases		2		1	6		3	8			4	
Permitted Phases	2		2	6		6	8		8	4		4
Detector Phase	2	2	2	1	6	6	3	8	8	4	4	4
Switch Phase												
Minimum Initial (s)	20.0	20.0	20.0	6.0	20.0	20.0	6.0	10.0	10.0	10.0	10.0	10.0
Minimum Split (s)	43.9	43.9	43.9	9.0	43.9	43.9	9.0	37.4	37.4	37.4	37.4	37.4
Total Split (s)	44.0	44.0	44.0	9.0	53.0	53.0	9.0	47.0	47.0	38.0	38.0	38.0
Total Split (%)	44.0%	44.0%	44.0%	9.0%	53.0%	53.0%	9.0%	47.0%	47.0%	38.0%	38.0%	38.0%
Maximum Green (s)	37.1	37.1	37.1	7.0	46.1	46.1	7.0	40.6	40.6	31.6	31.6	31.6
Yellow Time (s)	5.0	5.0	5.0	2.0	5.0	5.0	2.0	4.1	4.1	4.1	4.1	4.1
All-Red Time (s)	1.9	1.9	1.9	0.0	1.9	1.9	0.0	2.3	2.3	2.3	2.3	2.3
Lost Time Adjust (s)	0.0	0.0	0.0	0.0	0.0	0.0		0.0	0.0		0.0	0.0
Total Lost Time (s)	6.9	6.9	6.9	2.0	6.9	6.9		6.4	6.4		6.4	6.4
Lead/Lag	Lag	Lag	Lag	Lead			Lead			Lag	Lag	Lag
Lead-Lag Optimize?	Yes	Yes	Yes	Yes			Yes			Yes	Yes	Yes
Vehicle Extension (s)	4.5	4.5	4.5	2.0	4.5	4.5	2.0	3.0	3.0	3.0	3.0	3.0
Recall Mode	Min	Min	Min	None	Min	Min	None	None	None	None	None	None
Walk Time (s)	7.0	7.0	7.0		7.0	7.0		7.0	7.0	7.0	7.0	7.0
Flash Dont Walk (s)	30.0	30.0	30.0		30.0	30.0		24.0	24.0	24.0	24.0	24.0
Pedestrian Calls (#/hr)	0	0	0		0	0		1	1	0	0	0
Act Effct Green (s)	32.1	32.1	32.1	46.3	41.3	41.3		36.8	36.8		36.8	36.8
Actuated g/C Ratio	0.35	0.35	0.35	0.50	0.45	0.45		0.40	0.40		0.40	0.40
v/c Ratio	0.28	0.44	0.41	0.52	0.41	0.02		0.89	0.33		0.27	0.17
Control Delay	25.5	24.3	4.4	18.5	18.3	0.1		48.3	3.9		21.4	6.8
Queue Delay	0.0	0.0	0.0	0.0	0.0	0.0		0.0	0.0		0.0	0.0
Total Delay	25.5	24.3	4.4	18.5	18.3	0.1		48.3	3.9		21.4	6.8
LOS	C	C	A	B	B	A		D	A		C	A
Approach Delay		17.8			18.0			32.7			14.4	
Approach LOS		B			B			C			B	
Queue Length 50th (m)	10.8	41.9	0.0	25.2	43.7	0.0		81.4	0.0		17.1	2.9
Queue Length 95th (m)	23.1	56.8	17.0	40.3	58.1	0.0		#142.0	14.7		31.4	13.9
Internal Link Dist (m)		431.2			299.0			454.4			538.7	
Turn Bay Length (m)	50.0		75.0	40.0		30.0						7.5
Base Capacity (vph)	323	1451	822	444	1753	820		563	807		493	719
Starvation Cap Reductn	0	0	0	0	0	0		0	0		0	0
Spillback Cap Reductn	0	0	0	0	0	0		0	0		0	0
Storage Cap Reductn	0	0	0	0	0	0		0	0		0	0
Reduced v/c Ratio	0.24	0.37	0.37	0.52	0.36	0.02		0.79	0.30		0.26	0.16

**Intersection Summary**

Area Type:	Other
Cycle Length:	100
Actuated Cycle Length:	91.7
Natural Cycle:	100
Control Type:	Semi Act-Uncoord
Maximum v/c Ratio:	0.89
Intersection Signal Delay:	21.3
Intersection Capacity Utilization	79.8%
Intersection LOS:	C
ICU Level of Service	D

Analysis Period (min) 15

# 95th percentile volume exceeds capacity, queue may be longer.

Queue shown is maximum after two cycles.

Splits and Phases: 12: Wilson Street /Canadian tire Ent/Ext & HWY 7

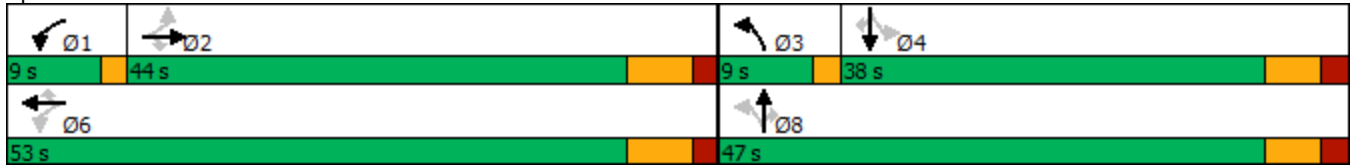

Perthmore Subdivision TIS  
 15: Drummond Street/Dufferin Street & HWY 7

2030 Total Conditions  
 AM Peak Hour



Lane Group	EBL	EBT	EBR	WBL	WBT	WBR	NBL	NBT	NBR	SBL	SBT	SBR
Lane Configurations												
Traffic Volume (vph)	87	374	216	123	524	20	262	60	130	17	58	100
Future Volume (vph)	87	374	216	123	524	20	262	60	130	17	58	100
Ideal Flow (vphpl)	1900	1900	1900	1900	1900	1900	1900	1900	1900	1900	1900	1900
Storage Length (m)	30.0		45.0	30.0		15.0	65.0		0.0	40.0		0.0
Storage Lanes	1		1	1		0	1		0	1		0
Taper Length (m)	7.5			7.5			0.0			20.0		
Lane Util. Factor	1.00	0.95	1.00	1.00	0.95	0.95	1.00	1.00	1.00	1.00	1.00	1.00
Ped Bike Factor								0.99		1.00		
Frt			0.850		0.995			0.897				0.905
Flt Protected	0.950			0.950			0.950			0.950		
Satd. Flow (prot)	1736	3374	1583	1752	3291	0	1770	1656	0	1671	1678	0
Flt Permitted	0.423			0.443			0.421			0.622		
Satd. Flow (perm)	773	3374	1583	817	3291	0	784	1656	0	1094	1678	0
Right Turn on Red			Yes			Yes			Yes			Yes
Satd. Flow (RTOR)			237		5			149				99
Link Speed (k/h)		60			60			50				50
Link Distance (m)		323.0			159.3			376.3				291.5
Travel Time (s)		19.4			9.6			27.1				21.0
Confl. Peds. (#/hr)									1	1		
Peak Hour Factor	0.91	0.91	0.91	0.90	0.90	0.90	0.87	0.87	0.87	0.77	0.77	0.77
Heavy Vehicles (%)	4%	7%	2%	3%	9%	13%	2%	2%	2%	8%	5%	1%
Adj. Flow (vph)	96	411	237	137	582	22	301	69	149	22	75	130
Shared Lane Traffic (%)												
Lane Group Flow (vph)	96	411	237	137	604	0	301	218	0	22	205	0
Enter Blocked Intersection	No	No	No	No	No	No	No	No	No	No	No	No
Lane Alignment	Left	Left	Right	Left	Left	Right	Left	Left	Right	Left	Left	Right
Median Width(m)		3.6			3.6			3.6				3.6
Link Offset(m)		0.0			0.0			0.0				0.0
Crosswalk Width(m)		4.8			4.8			4.8				4.8
Two way Left Turn Lane												
Headway Factor	1.00	1.00	1.00	1.00	1.00	1.00	1.00	1.00	1.00	1.00	1.00	1.00
Turning Speed (k/h)	25		15	25		15	25		15	25		15
Number of Detectors	1	1	1	1	2		1	1		1	1	
Detector Template	Left		Right	Left								
Leading Detector (m)	2.0	94.8	2.0	2.0	86.8		9.0	9.0		9.0	9.0	
Trailing Detector (m)	0.0	93.0	0.0	0.0	-1.0		-3.0	-3.0		-3.0	-3.0	
Detector 1 Position(m)	0.0	93.0	0.0	0.0	-1.0		-3.0	-3.0		-3.0	-3.0	
Detector 1 Size(m)	2.0	1.8	2.0	2.0	12.0		12.0	12.0		12.0	12.0	
Detector 1 Type	Cl+Ex	Cl+Ex	Cl+Ex	Cl+Ex	Cl+Ex		Cl+Ex	Cl+Ex		Cl+Ex	Cl+Ex	
Detector 1 Channel												
Detector 1 Extend (s)	0.0	0.0	0.0	0.0	0.0		0.0	0.0		0.0	0.0	
Detector 1 Queue (s)	0.0	0.0	0.0	0.0	0.0		0.0	0.0		0.0	0.0	
Detector 1 Delay (s)	0.0	0.0	0.0	0.0	0.0		0.0	0.0		0.0	0.0	
Detector 2 Position(m)					85.0							
Detector 2 Size(m)					1.8							
Detector 2 Type					Cl+Ex							
Detector 2 Channel												
Detector 2 Extend (s)					0.0							



Perthmore Subdivision TIS  
 15: Drummond Street/Dufferin Street & HWY 7

2030 Total Conditions  
 AM Peak Hour



Lane Group	EBL	EBT	EBR	WBL	WBT	WBR	NBL	NBT	NBR	SBL	SBT	SBR
Turn Type	Perm	NA	Perm	pm+pt	NA		pm+pt	NA		Perm	NA	
Protected Phases		2		1	6		3	8				4
Permitted Phases	2		2	6			8			4		
Detector Phase	2	2	2	1	6		3	8		4		4
Switch Phase												
Minimum Initial (s)	20.0	20.0	20.0	7.0	20.0		5.0	10.0		10.0		10.0
Minimum Split (s)	33.3	33.3	33.3	10.0	36.3		9.5	38.3		38.3		38.3
Total Split (s)	33.7	33.7	33.7	10.0	43.7		13.0	51.3		38.3		38.3
Total Split (%)	35.5%	35.5%	35.5%	10.5%	46.0%		13.7%	54.0%		40.3%		40.3%
Maximum Green (s)	27.4	27.4	27.4	7.0	37.4		8.5	45.0		32.0		32.0
Yellow Time (s)	5.0	5.0	5.0	3.0	5.0		3.5	4.1		4.1		4.1
All-Red Time (s)	1.3	1.3	1.3	0.0	1.3		1.0	2.2		2.2		2.2
Lost Time Adjust (s)	0.0	0.0	0.0	0.0	0.0		0.0	0.0		0.0		0.0
Total Lost Time (s)	6.3	6.3	6.3	3.0	6.3		4.5	6.3		6.3		6.3
Lead/Lag	Lag	Lag	Lag	Lead			Lead			Lag		Lag
Lead-Lag Optimize?	Yes	Yes	Yes	Yes			Yes			Yes		Yes
Vehicle Extension (s)	4.6	4.6	4.6	3.0	4.6		3.0	3.0		3.0		3.0
Recall Mode	Min	Min	Min	None	Min		None	None		None		None
Walk Time (s)	7.0	7.0	7.0		7.0			7.0		7.0		7.0
Flash Dont Walk (s)	20.0	20.0	20.0		20.0			25.0		25.0		25.0
Pedestrian Calls (#/hr)	0	0	0		0			1		0		0
Act Effct Green (s)	21.0	21.0	21.0	34.4	31.0		26.9	25.1		12.0		12.0
Actuated g/C Ratio	0.31	0.31	0.31	0.50	0.45		0.39	0.36		0.17		0.17
v/c Ratio	0.41	0.40	0.37	0.27	0.41		0.70	0.31		0.12		0.55
Control Delay	26.2	20.7	4.8	11.5	14.0		26.2	6.9		25.4		19.7
Queue Delay	0.0	0.0	0.0	0.0	0.0		0.0	0.0		0.0		0.0
Total Delay	26.2	20.7	4.8	11.5	14.0		26.2	6.9		25.4		19.7
LOS	C	C	A	B	B		C	A		C		B
Approach Delay		16.3			13.5			18.1				20.2
Approach LOS		B			B			B				C
Queue Length 50th (m)	9.7	21.6	0.0	8.7	25.4		28.1	5.9		2.5		12.5
Queue Length 95th (m)	26.1	39.1	15.2	21.8	46.4		50.2	19.0		7.3		24.8
Internal Link Dist (m)		299.0			135.3			352.3				267.5
Turn Bay Length (m)	30.0		45.0	30.0			65.0			40.0		
Base Capacity (vph)	309	1350	775	503	1800		429	1139		511		837
Starvation Cap Reductn	0	0	0	0	0		0	0		0		0
Spillback Cap Reductn	0	0	0	0	0		0	0		0		0
Storage Cap Reductn	0	0	0	0	0		0	0		0		0
Reduced v/c Ratio	0.31	0.30	0.31	0.27	0.34		0.70	0.19		0.04		0.24

Intersection Summary

Area Type:	Other
Cycle Length:	95
Actuated Cycle Length:	68.8
Natural Cycle:	95
Control Type:	Semi Act-Uncoord
Maximum v/c Ratio:	0.70
Intersection Signal Delay:	16.2
Intersection Capacity Utilization	76.5%
Intersection LOS:	B
ICU Level of Service	D

Analysis Period (min) 15

Splits and Phases: 15: Drummond Street/Dufferin Street & HWY 7

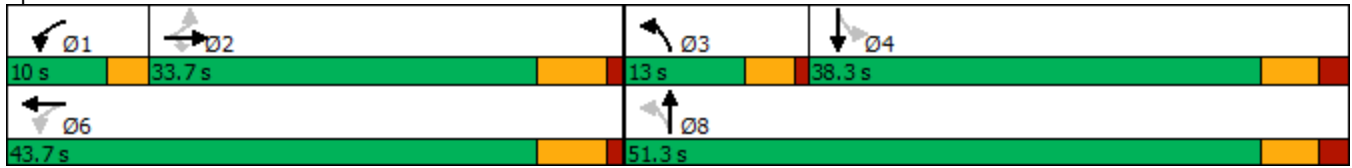

Perthmore Subdivision TIS  
26: Wilson Street & Sunset Boulevard

2030 Total Conditions  
AM Peak Hour



Lane Group	EBL	EBT	EBR	WBL	WBT	WBR	NBL	NBT	NBR	SBL	SBT	SBR
Lane Configurations		↕	↗		↕		↗	↖		↖	↕	↗
Traffic Volume (vph)	95	15	180	12	47	19	120	399	0	5	464	59
Future Volume (vph)	95	15	180	12	47	19	120	399	0	5	464	59
Ideal Flow (vphpl)	1900	1900	1900	1900	1900	1900	1900	1900	1900	1900	1900	1900
Storage Length (m)	0.0		0.0	0.0		0.0	15.0		0.0	25.0		0.0
Storage Lanes	0		1	0		0	1		0	1		1
Taper Length (m)	7.5			7.5			7.5			7.5		
Lane Util. Factor	1.00	1.00	1.00	1.00	1.00	1.00	1.00	1.00	1.00	1.00	1.00	1.00
Ped Bike Factor		0.98	0.97		0.99		0.99			1.00		0.94
Frt			0.850		0.967							0.850
Flt Protected		0.959			0.992		0.950			0.950		
Satd. Flow (prot)	0	1704	1524	0	1774	0	1787	1792	0	1805	1810	1583
Flt Permitted		0.746			0.936		0.238			0.435		
Satd. Flow (perm)	0	1300	1483	0	1672	0	441	1792	0	824	1810	1484
Right Turn on Red			Yes			Yes			Yes			Yes
Satd. Flow (RTOR)			313		28							113
Link Speed (k/h)		50			50			50				50
Link Distance (m)		357.7			280.8			341.7				184.3
Travel Time (s)		25.8			20.2			24.6				13.3
Confl. Peds. (#/hr)	27		4	4		27	26		5	5		26
Peak Hour Factor	0.55	0.55	0.55	0.64	0.64	0.64	0.85	0.85	0.85	0.86	0.86	0.86
Heavy Vehicles (%)	8%	0%	6%	0%	3%	0%	1%	6%	0%	0%	5%	2%
Adj. Flow (vph)	173	27	327	19	73	30	141	469	0	6	540	69
Shared Lane Traffic (%)												
Lane Group Flow (vph)	0	200	327	0	122	0	141	469	0	6	540	69
Enter Blocked Intersection	No	No	No	No	No	No	No	No	No	No	No	No
Lane Alignment	Left	Left	Right	Left	Left	Right	Left	Left	Right	Left	Left	Right
Median Width(m)		0.0			0.0			3.6				3.6
Link Offset(m)		0.0			0.0			0.0				0.0
Crosswalk Width(m)		4.8			4.8			4.8				4.8
Two way Left Turn Lane												
Headway Factor	1.00	1.00	1.00	1.00	1.00	1.00	1.00	1.00	1.00	1.00	1.00	1.00
Turning Speed (k/h)	25		15	25		15	25		15	25		15
Number of Detectors	1	2	1	1	2		1	2		1	2	1
Detector Template	Left	Thru	Right	Left	Thru		Left	Thru		Left	Thru	Right
Leading Detector (m)	2.0	10.0	2.0	2.0	10.0		2.0	10.0		2.0	10.0	2.0
Trailing Detector (m)	0.0	0.0	0.0	0.0	0.0		0.0	0.0		0.0	0.0	0.0
Detector 1 Position(m)	0.0	0.0	0.0	0.0	0.0		0.0	0.0		0.0	0.0	0.0
Detector 1 Size(m)	2.0	0.6	2.0	2.0	0.6		2.0	0.6		2.0	0.6	2.0
Detector 1 Type	Cl+Ex	Cl+Ex	Cl+Ex	Cl+Ex	Cl+Ex		Cl+Ex	Cl+Ex		Cl+Ex	Cl+Ex	Cl+Ex
Detector 1 Channel												
Detector 1 Extend (s)	0.0	0.0	0.0	0.0	0.0		0.0	0.0		0.0	0.0	0.0
Detector 1 Queue (s)	0.0	0.0	0.0	0.0	0.0		0.0	0.0		0.0	0.0	0.0
Detector 1 Delay (s)	0.0	0.0	0.0	0.0	0.0		0.0	0.0		0.0	0.0	0.0
Detector 2 Position(m)		9.4			9.4			9.4				9.4
Detector 2 Size(m)		0.6			0.6			0.6				0.6
Detector 2 Type		Cl+Ex			Cl+Ex			Cl+Ex				Cl+Ex
Detector 2 Channel												
Detector 2 Extend (s)		0.0			0.0			0.0				0.0

Perthmore Subdivision TIS  
26: Wilson Street & Sunset Boulevard

2030 Total Conditions  
AM Peak Hour



Lane Group	EBL	EBT	EBR	WBL	WBT	WBR	NBL	NBT	NBR	SBL	SBT	SBR
Turn Type	Perm	NA	Perm	Perm	NA		pm+pt	NA		pm+pt	NA	Perm
Protected Phases		4			8		5	2		1	6	
Permitted Phases	4		4	8			2			6		6
Detector Phase	4	4	4	8	8		5	2		1	6	6
Switch Phase							2			6		
Minimum Initial (s)	10.0	10.0	10.0	10.0	10.0		5.0	10.0		5.0	10.0	10.0
Minimum Split (s)	22.6	22.6	22.6	22.6	22.6		9.6	22.6		9.6	22.6	22.6
Total Split (s)	22.6	22.6	22.6	22.6	22.6		9.6	27.8		9.6	27.8	27.8
Total Split (%)	37.7%	37.7%	37.7%	37.7%	37.7%		16.0%	46.3%		16.0%	46.3%	46.3%
Maximum Green (s)	18.0	18.0	18.0	18.0	18.0		5.0	23.2		5.0	23.2	23.2
Yellow Time (s)	3.3	3.3	3.3	3.3	3.3		3.3	3.3		3.3	3.3	3.3
All-Red Time (s)	1.3	1.3	1.3	1.3	1.3		1.3	1.3		1.3	1.3	1.3
Lost Time Adjust (s)		0.0	0.0		0.0		0.0	0.0		0.0	0.0	0.0
Total Lost Time (s)		4.6	4.6		4.6		4.6	4.6		4.6	4.6	4.6
Lead/Lag							Lead	Lag		Lead	Lag	Lag
Lead-Lag Optimize?							Yes	Yes		Yes	Yes	Yes
Vehicle Extension (s)	3.0	3.0	3.0	3.0	3.0		3.0	3.0		3.0	3.0	3.0
Recall Mode	None	None	None	None	None		None	Min		None	Min	Min
Walk Time (s)	7.0	7.0	7.0	7.0	7.0			7.0			7.0	7.0
Flash Dont Walk (s)	11.0	11.0	11.0	11.0	11.0			11.0			11.0	11.0
Pedestrian Calls (#/hr)	5	5	5	20	20			20			4	4
Act Effct Green (s)		14.0	14.0		14.0		25.1	24.3		22.5	18.8	18.8
Actuated g/C Ratio		0.28	0.28		0.28		0.51	0.49		0.45	0.38	0.38
v/c Ratio		0.55	0.51		0.25		0.38	0.54		0.01	0.79	0.11
Control Delay		23.8	6.1		14.4		9.4	12.7		6.2	25.0	1.6
Queue Delay		0.0	0.0		0.0		0.0	0.0		0.0	0.0	0.0
Total Delay		23.8	6.1		14.4		9.4	12.7		6.2	25.0	1.6
LOS		C	A		B		A	B		A	C	A
Approach Delay		12.8			14.4			11.9			22.2	
Approach LOS		B			B			B			C	
Queue Length 50th (m)		17.8	1.1		7.5		5.8	24.0		0.3	45.5	0.0
Queue Length 95th (m)		20.0	0.0		12.3		13.6	67.0		1.5	#85.5	2.7
Internal Link Dist (m)		333.7			256.8			317.7			160.3	
Turn Bay Length (m)							15.0			25.0		
Base Capacity (vph)		502	765		664		367	1027		478	902	796
Starvation Cap Reductn		0	0		0		0	0		0	0	0
Spillback Cap Reductn		0	0		0		0	0		0	0	0
Storage Cap Reductn		0	0		0		0	0		0	0	0
Reduced v/c Ratio		0.40	0.43		0.18		0.38	0.46		0.01	0.60	0.09

Intersection Summary

Area Type:	Other
Cycle Length:	60
Actuated Cycle Length:	49.7
Natural Cycle:	60
Control Type:	Semi Act-Uncoord
Maximum v/c Ratio:	0.79
Intersection Signal Delay:	15.7
Intersection Capacity Utilization	60.2%
Intersection LOS:	B
ICU Level of Service	B

Analysis Period (min) 15

# 95th percentile volume exceeds capacity, queue may be longer.

Queue shown is maximum after two cycles.

Splits and Phases: 26: Wilson Street & Sunset Boulevard

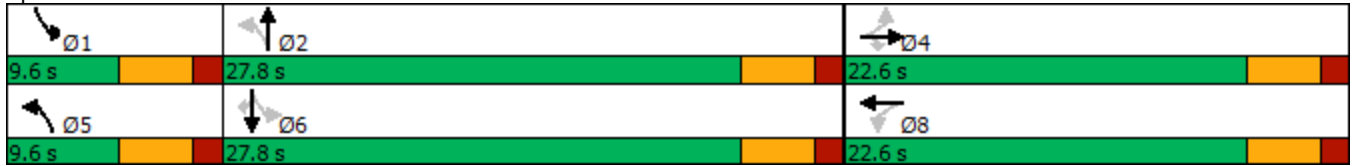

Perthmore Subdivision TIS  
30: Wilson Street & Leslie Street/Isabella Street

2030 Total Conditions  
AM Peak Hour



Lane Group	EBL	EBT	EBR	WBL	WBT	WBR	NBL	NBT	NBR	SBL	SBT	SBR
Lane Configurations		↕			↕		↗	↘		↗	↘	
Traffic Volume (vph)	27	10	3	18	9	61	0	420	3	44	516	28
Future Volume (vph)	27	10	3	18	9	61	0	420	3	44	516	28
Ideal Flow (vphpl)	1900	1900	1900	1900	1900	1900	1900	1900	1900	1900	1900	1900
Storage Length (m)	0.0		0.0	0.0		0.0	60.0		0.0	25.0		0.0
Storage Lanes	0		0	0		0	1		0	1		0
Taper Length (m)	7.5			7.5			25.0			15.0		
Lane Util. Factor	1.00	1.00	1.00	1.00	1.00	1.00	1.00	1.00	1.00	1.00	1.00	1.00
Ped Bike Factor		0.97			0.95			1.00		0.99	1.00	
Frt		0.990			0.907			0.999			0.992	
Flt Protected		0.967			0.990					0.950		
Satd. Flow (prot)	0	1512	0	0	1551	0	1900	1758	0	1752	1746	0
Flt Permitted		0.817			0.920					0.322		
Satd. Flow (perm)	0	1241	0	0	1438	0	1900	1758	0	589	1746	0
Right Turn on Red			Yes			Yes			Yes			Yes
Satd. Flow (RTOR)		4			85			1			7	
Link Speed (k/h)		50			50			50			50	
Link Distance (m)		227.0			415.9			340.1			341.7	
Travel Time (s)		16.3			29.9			24.5			24.6	
Confl. Peds. (#/hr)	20		4	4		20	5		14	14		5
Peak Hour Factor	0.78	0.78	0.78	0.72	0.72	0.72	0.82	0.82	0.82	0.82	0.82	0.82
Heavy Vehicles (%)	24%	0%	50%	0%	14%	4%	0%	8%	0%	3%	7%	23%
Adj. Flow (vph)	35	13	4	25	13	85	0	512	4	54	629	34
Shared Lane Traffic (%)												
Lane Group Flow (vph)	0	52	0	0	123	0	0	516	0	54	663	0
Enter Blocked Intersection	No	No	No	No	No	No	No	No	No	No	No	No
Lane Alignment	Left	Left	Right	Left	Left	Right	Left	Left	Right	Left	Left	Right
Median Width(m)		0.0			0.0			3.6			3.6	
Link Offset(m)		0.0			0.0			0.0			0.0	
Crosswalk Width(m)		4.8			4.8			4.8			4.8	
Two way Left Turn Lane												
Headway Factor	1.00	1.00	1.00	1.00	1.00	1.00	1.00	1.00	1.00	1.00	1.00	1.00
Turning Speed (k/h)	25		15	25		15	25		15	25		15
Number of Detectors	1	2		1	2		1	2		1	2	
Detector Template	Left	Thru		Left	Thru		Left	Thru		Left	Thru	
Leading Detector (m)	2.0	10.0		2.0	10.0		2.0	10.0		2.0	10.0	
Trailing Detector (m)	0.0	0.0		0.0	0.0		0.0	0.0		0.0	0.0	
Detector 1 Position(m)	0.0	0.0		0.0	0.0		0.0	0.0		0.0	0.0	
Detector 1 Size(m)	2.0	0.6		2.0	0.6		2.0	0.6		2.0	0.6	
Detector 1 Type	Cl+Ex	Cl+Ex		Cl+Ex	Cl+Ex		Cl+Ex	Cl+Ex		Cl+Ex	Cl+Ex	
Detector 1 Channel												
Detector 1 Extend (s)	0.0	0.0		0.0	0.0		0.0	0.0		0.0	0.0	
Detector 1 Queue (s)	0.0	0.0		0.0	0.0		0.0	0.0		0.0	0.0	
Detector 1 Delay (s)	0.0	0.0		0.0	0.0		0.0	0.0		0.0	0.0	
Detector 2 Position(m)		9.4			9.4			9.4			9.4	
Detector 2 Size(m)		0.6			0.6			0.6			0.6	
Detector 2 Type		Cl+Ex			Cl+Ex			Cl+Ex			Cl+Ex	
Detector 2 Channel												
Detector 2 Extend (s)		0.0			0.0			0.0			0.0	

Perthmore Subdivision TIS  
 30: Wilson Street & Leslie Street/Isabella Street

2030 Total Conditions  
 AM Peak Hour



Lane Group	EBL	EBT	EBR	WBL	WBT	WBR	NBL	NBT	NBR	SBL	SBT	SBR
Turn Type	Perm	NA		Perm	NA		pm+pt	NA		pm+pt	NA	
Protected Phases		4			8		5	2		1	6	
Permitted Phases	4			8			2			6		
Detector Phase	4	4		8	8		5	2		1	6	
Switch Phase							2			6		
Minimum Initial (s)	10.0	10.0		10.0	10.0		5.0	10.0		5.0	10.0	
Minimum Split (s)	15.1	15.1		15.1	15.1		9.6	35.0		9.6	35.0	
Total Split (s)	15.1	15.1		15.1	15.1		9.6	35.3		9.6	35.3	
Total Split (%)	25.2%	25.2%		25.2%	25.2%		16.0%	58.8%		16.0%	58.8%	
Maximum Green (s)	10.5	10.5		10.5	10.5		5.0	30.7		5.0	30.7	
Yellow Time (s)	3.3	3.3		3.3	3.3		3.3	3.3		3.3	3.3	
All-Red Time (s)	1.3	1.3		1.3	1.3		1.3	1.3		1.3	1.3	
Lost Time Adjust (s)		0.0			0.0		0.0	0.0		0.0	0.0	
Total Lost Time (s)		4.6			4.6		4.6	4.6		4.6	4.6	
Lead/Lag							Lead	Lag		Lead	Lag	
Lead-Lag Optimize?							Yes	Yes		Yes	Yes	
Vehicle Extension (s)	3.0	3.0		3.0	3.0		3.0	3.0		3.0	3.0	
Recall Mode	None	None		None	None		None	Min		None	Min	
Walk Time (s)	6.0	6.0		6.0	6.0			7.0			7.0	
Flash Dont Walk (s)	4.5	4.5		4.5	4.5			11.0			11.0	
Pedestrian Calls (#/hr)	14	14		5	5			18			4	
Act Effct Green (s)		10.7			10.7			25.8		27.5	28.9	
Actuated g/C Ratio		0.25			0.25			0.59		0.63	0.66	
v/c Ratio		0.17			0.30			0.50		0.11	0.57	
Control Delay		18.2			10.6			10.8		4.4	8.2	
Queue Delay		0.0			0.0			0.0		0.0	0.0	
Total Delay		18.2			10.6			10.8		4.4	8.2	
LOS		B			B			B		A	A	
Approach Delay		18.2			10.6			10.8			7.9	
Approach LOS		B			B			B			A	
Queue Length 50th (m)		2.5			1.9			21.4		1.6	31.0	
Queue Length 95th (m)		11.3			10.9			55.1		4.0	46.0	
Internal Link Dist (m)		203.0			391.9			316.1			317.7	
Turn Bay Length (m)										25.0		
Base Capacity (vph)		319			429			1297		512	1346	
Starvation Cap Reductn		0			0			0		0	0	
Spillback Cap Reductn		0			0			0		0	0	
Storage Cap Reductn		0			0			0		0	0	
Reduced v/c Ratio		0.16			0.29			0.40		0.11	0.49	

Intersection Summary

Area Type:	Other
Cycle Length:	60
Actuated Cycle Length:	43.6
Natural Cycle:	60
Control Type:	Semi Act-Uncoord
Maximum v/c Ratio:	0.57
Intersection Signal Delay:	9.6
Intersection Capacity Utilization	52.8%
Intersection LOS:	A
ICU Level of Service	A

Analysis Period (min) 15

Splits and Phases: 30: Wilson Street & Leslie Street/Isabella Street





Intersection	
Intersection Delay, s/veh	25.8
Intersection LOS	D

Movement	EBL	EBT	EBR	WBL	WBT	WBR	NBL	NBT	NBR	SBL	SBT	SBR
Lane Configurations		↕			↕			↕			↕	
Traffic Vol, veh/h	12	97	12	72	106	101	4	221	43	106	250	18
Future Vol, veh/h	12	97	12	72	106	101	4	221	43	106	250	18
Peak Hour Factor	0.67	0.67	0.67	0.88	0.88	0.88	0.90	0.90	0.90	0.78	0.78	0.78
Heavy Vehicles, %	0	16	0	0	14	0	0	2	3	1	3	7
Mvmt Flow	18	145	18	82	120	115	4	246	48	136	321	23
Number of Lanes	0	1	0	0	1	0	0	1	0	0	1	0

Approach	EB	WB	NB	SB
Opposing Approach	WB	EB	SB	NB
Opposing Lanes	1	1	1	1
Conflicting Approach Left	SB	NB	EB	WB
Conflicting Lanes Left	1	1	1	1
Conflicting Approach Right	NB	SB	WB	EB
Conflicting Lanes Right	1	1	1	1
HCM Control Delay	14.9	19.9	18.2	38.5
HCM LOS	B	C	C	E

Lane	NBLn1	EBLn1	WBLn1	SBLn1
Vol Left, %	1%	10%	26%	28%
Vol Thru, %	82%	80%	38%	67%
Vol Right, %	16%	10%	36%	5%
Sign Control	Stop	Stop	Stop	Stop
Traffic Vol by Lane	268	121	279	374
LT Vol	4	12	72	106
Through Vol	221	97	106	250
RT Vol	43	12	101	18
Lane Flow Rate	298	181	317	479
Geometry Grp	1	1	1	1
Degree of Util (X)	0.561	0.372	0.603	0.869
Departure Headway (Hd)	6.778	7.41	6.849	6.528
Convergence, Y/N	Yes	Yes	Yes	Yes
Cap	530	484	526	561
Service Time	4.84	5.485	4.911	4.528
HCM Lane V/C Ratio	0.562	0.374	0.603	0.854
HCM Control Delay	18.2	14.9	19.9	38.5
HCM Lane LOS	C	B	C	E
HCM 95th-tile Q	3.4	1.7	4	9.6

Perthmore Subdivision TIS  
 3: Drummond Concession 2 & Perthmore

2030 Total Conditions  
 AM Peak Hour

Intersection						
Int Delay, s/veh	2.4					
Movement	EBL	EBT	WBT	WBR	SBL	SBR
Lane Configurations		↕	↑	↗	↘	
Traffic Vol, veh/h	25	127	194	7	17	54
Future Vol, veh/h	25	127	194	7	17	54
Conflicting Peds, #/hr	0	0	0	0	0	0
Sign Control	Free	Free	Free	Free	Stop	Stop
RT Channelized	-	None	-	None	-	None
Storage Length	-	-	-	25	0	-
Veh in Median Storage, #	-	0	0	-	0	-
Grade, %	-	0	0	-	0	-
Peak Hour Factor	83	83	84	84	78	78
Heavy Vehicles, %	50	9	1	25	0	12
Mvmt Flow	30	153	231	8	22	69

Major/Minor	Major1	Major2	Minor2		
Conflicting Flow All	239	0	0	444	231
Stage 1	-	-	-	231	-
Stage 2	-	-	-	213	-
Critical Hdwy	4.6	-	-	6.4	6.32
Critical Hdwy Stg 1	-	-	-	5.4	-
Critical Hdwy Stg 2	-	-	-	5.4	-
Follow-up Hdwy	2.65	-	-	3.5	3.408
Pot Cap-1 Maneuver	1092	-	-	575	784
Stage 1	-	-	-	812	-
Stage 2	-	-	-	827	-
Platoon blocked, %	-	-	-	-	-
Mov Cap-1 Maneuver	1092	-	-	558	784
Mov Cap-2 Maneuver	-	-	-	558	-
Stage 1	-	-	-	788	-
Stage 2	-	-	-	827	-

Approach	EB	WB	SB
HCM Control Delay, s	1.4	0	10.8
HCM LOS			B

Minor Lane/Major Mvmt	EBL	EBT	WBT	WBR	SBLn1
Capacity (veh/h)	1092	-	-	-	715
HCM Lane V/C Ratio	0.028	-	-	-	0.127
HCM Control Delay (s)	8.4	0	-	-	10.8
HCM Lane LOS	A	A	-	-	B
HCM 95th %tile Q(veh)	0.1	-	-	-	0.4

Intersection						
Int Delay, s/veh	5.7					
Movement	EBT	EBR	WBL	WBT	NBL	NBR
Lane Configurations						
Traffic Vol, veh/h	62	91	21	51	78	19
Future Vol, veh/h	62	91	21	51	78	19
Conflicting Peds, #/hr	0	0	0	0	0	24
Sign Control	Free	Free	Free	Free	Stop	Stop
RT Channelized	-	None	-	None	-	None
Storage Length	-	-	-	-	0	-
Veh in Median Storage, #	0	-	-	0	0	-
Grade, %	0	-	-	0	0	-
Peak Hour Factor	63	63	68	68	41	41
Heavy Vehicles, %	2	25	17	8	3	15
Mvmt Flow	98	144	31	75	190	46

Major/Minor	Major1	Major2	Minor1		
Conflicting Flow All	0	0	242	0	307
Stage 1	-	-	-	-	170
Stage 2	-	-	-	-	137
Critical Hdwy	-	-	4.27	-	6.43
Critical Hdwy Stg 1	-	-	-	-	5.43
Critical Hdwy Stg 2	-	-	-	-	5.43
Follow-up Hdwy	-	-	2.353	-	3.527
Pot Cap-1 Maneuver	-	-	1241	-	683
Stage 1	-	-	-	-	857
Stage 2	-	-	-	-	887
Platoon blocked, %	-	-	-	-	-
Mov Cap-1 Maneuver	-	-	1241	-	665
Mov Cap-2 Maneuver	-	-	-	-	665
Stage 1	-	-	-	-	857
Stage 2	-	-	-	-	864

Approach	EB	WB	NB
HCM Control Delay, s	0	2.3	13
HCM LOS			B

Minor Lane/Major Mvmt	NBLn1	EBT	EBR	WBL	WBT
Capacity (veh/h)	687	-	-	1241	-
HCM Lane V/C Ratio	0.344	-	-	0.025	-
HCM Control Delay (s)	13	-	-	8	0
HCM Lane LOS	B	-	-	A	A
HCM 95th %tile Q(veh)	1.5	-	-	0.1	-

Perthmore Subdivision TIS  
34: Wilson Street & North Street

2030 Total Conditions  
AM Peak Hour

Intersection												
Int Delay, s/veh	3.4											
Movement	EBL	EBT	EBR	WBL	WBT	WBR	NBL	NBT	NBR	SBL	SBT	SBR
Lane Configurations		↕			↕			↕			↕	
Traffic Vol, veh/h	6	5	10	11	4	82	6	362	11	84	440	20
Future Vol, veh/h	6	5	10	11	4	82	6	362	11	84	440	20
Conflicting Peds, #/hr	3	0	3	3	0	3	12	0	9	9	0	12
Sign Control	Stop	Stop	Stop	Stop	Stop	Stop	Free	Free	Free	Free	Free	Free
RT Channelized	-	-	None	-	-	None	-	-	None	-	-	None
Storage Length	-	-	-	-	-	-	-	-	-	-	-	65
Veh in Median Storage, #	-	0	-	-	0	-	-	0	-	-	0	-
Grade, %	-	0	-	-	0	-	-	0	-	-	0	-
Peak Hour Factor	71	71	71	77	77	77	89	89	89	79	79	79
Heavy Vehicles, %	20	0	0	0	0	28	0	6	0	29	2	25
Mvmt Flow	8	7	14	14	5	106	7	407	12	106	557	25

Major/Minor	Minor2		Minor1		Major1			Major2				
Conflicting Flow All	1280	1236	306	933	1242	425	594	0	0	428	0	0
Stage 1	794	794	-	436	436	-	-	-	-	-	-	-
Stage 2	486	442	-	497	806	-	-	-	-	-	-	-
Critical Hdwy	7.6	6.5	6.9	7.3	6.5	6.62	4.1	-	-	4.535	-	-
Critical Hdwy Stg 1	6.8	5.5	-	6.1	5.5	-	-	-	-	-	-	-
Critical Hdwy Stg 2	6.4	5.5	-	6.5	5.5	-	-	-	-	-	-	-
Follow-up Hdwy	3.69	4	3.3	3.5	4	3.566	2.2	-	-	2.4755	-	-
Pot Cap-1 Maneuver	117	178	696	236	176	566	992	-	-	979	-	-
Stage 1	318	403	-	603	583	-	-	-	-	-	-	-
Stage 2	522	580	-	529	398	-	-	-	-	-	-	-
Platoon blocked, %								-	-	-	-	-
Mov Cap-1 Maneuver	79	145	687	192	144	560	982	-	-	972	-	-
Mov Cap-2 Maneuver	79	145	-	192	144	-	-	-	-	-	-	-
Stage 1	312	334	-	593	573	-	-	-	-	-	-	-
Stage 2	414	570	-	424	330	-	-	-	-	-	-	-

Approach	EB		WB		NB		SB	
HCM Control Delay, s	31		17.2		0.1		1.8	
HCM LOS	D		C					

Minor Lane/Major Mvmt	NBL	NBT	NBR	EBLn1WBLn1	SBL	SBT	SBR
Capacity (veh/h)	982	-	-	168	419	972	-
HCM Lane V/C Ratio	0.007	-	-	0.176	0.301	0.109	-
HCM Control Delay (s)	8.7	0	-	31	17.2	9.2	0.5
HCM Lane LOS	A	A	-	D	C	A	A
HCM 95th %tile Q(veh)	0	-	-	0.6	1.2	0.4	-

Perthmore Subdivision TIS  
 12: Wilson Street /Canadian tire Ent/Ext & HWY 7

2030 Total Traffic  
 PM Peak Hour



Lane Group	EBL	EBT	EBR	WBL	WBT	WBR	NBL	NBT	NBR	SBL	SBT	SBR
Lane Configurations	↘	↑↑	↗	↘	↑↑	↗		↗	↗		↗	↗
Traffic Volume (vph)	55	737	131	119	681	9	201	28	191	61	26	102
Future Volume (vph)	55	737	131	119	681	9	201	28	191	61	26	102
Ideal Flow (vphpl)	1900	1900	1900	1900	1900	1900	1900	1900	1900	1900	1900	1900
Storage Length (m)	50.0		75.0	40.0		30.0	0.0		0.0	0.0		7.5
Storage Lanes	1		1	1		1	0		1	0		1
Taper Length (m)	7.5			7.5			7.5			10.0		
Lane Util. Factor	1.00	0.95	1.00	1.00	0.95	1.00	1.00	1.00	1.00	1.00	1.00	1.00
Ped Bike Factor								1.00				0.99
Fr <sub>t</sub>			0.850			0.850			0.850			0.850
Fl <sub>t</sub> Protected	0.950			0.950				0.958			0.966	
Satd. Flow (prot)	1805	3471	1553	1752	3438	1615	0	1758	1509	0	1835	1615
Fl <sub>t</sub> Permitted	0.355			0.206				0.687			0.557	
Satd. Flow (perm)	674	3471	1553	380	3438	1615	0	1258	1509	0	1058	1591
Right Turn on Red			Yes			Yes			Yes			Yes
Satd. Flow (RTOR)			160			59			208			110
Link Speed (k/h)		60			60			50			50	
Link Distance (m)		455.2			323.0			478.2			562.7	
Travel Time (s)		27.3			19.4			34.4			40.5	
Confl. Peds. (#/hr)							3					3
Peak Hour Factor	0.82	0.82	0.82	0.87	0.87	0.87	0.70	0.70	0.70	0.93	0.93	0.93
Heavy Vehicles (%)	0%	4%	4%	3%	5%	0%	4%	0%	7%	0%	0%	0%
Adj. Flow (vph)	67	899	160	137	783	10	287	40	273	66	28	110
Shared Lane Traffic (%)												
Lane Group Flow (vph)	67	899	160	137	783	10	0	327	273	0	94	110
Enter Blocked Intersection	No	No	No	No	No	No	No	No	No	No	No	No
Lane Alignment	Left	Left	Right	Left	Left	Right	Left	Left	Right	Left	Left	Right
Median Width(m)		3.6			3.6			0.0			0.0	
Link Offset(m)		0.0			0.0			0.0			0.0	
Crosswalk Width(m)		4.8			4.8			4.8			4.8	
Two way Left Turn Lane												
Headway Factor	1.00	1.00	1.00	1.00	1.00	1.00	1.00	1.00	1.00	1.00	1.00	1.00
Turning Speed (k/h)	25		15	25		15	25		15	25		15
Number of Detectors	1	2	1	1	2	1	1	1	1	1	1	1
Detector Template	Left		Right	Left		Right	Left			Left		
Leading Detector (m)	2.0	98.8	2.0	2.0	91.8	2.0	2.0	9.0	9.0	2.0	9.0	9.0
Trailing Detector (m)	0.0	-3.0	0.0	0.0	-3.0	0.0	0.0	-3.0	-3.0	0.0	-0.2	-3.0
Detector 1 Position(m)	0.0	-3.0	0.0	0.0	-3.0	0.0	0.0	-3.0	-3.0	0.0	-0.2	-3.0
Detector 1 Size(m)	2.0	12.0	2.0	2.0	12.0	2.0	2.0	12.0	12.0	2.0	9.2	12.0
Detector 1 Type	Cl+Ex	Cl+Ex	Cl+Ex	Cl+Ex	Cl+Ex	Cl+Ex	Cl+Ex	Cl+Ex	Cl+Ex	Cl+Ex	Cl+Ex	Cl+Ex
Detector 1 Channel												
Detector 1 Extend (s)	0.0	0.0	0.0	0.0	0.0	0.0	0.0	0.0	0.0	0.0	0.0	0.0
Detector 1 Queue (s)	0.0	0.0	0.0	0.0	0.0	0.0	0.0	0.0	0.0	0.0	0.0	0.0
Detector 1 Delay (s)	0.0	0.0	0.0	0.0	0.0	0.0	0.0	0.0	0.0	0.0	0.0	0.0
Detector 2 Position(m)		97.0			90.0							
Detector 2 Size(m)		1.8			1.8							
Detector 2 Type		Cl+Ex			Cl+Ex							
Detector 2 Channel												
Detector 2 Extend (s)		0.0			0.0							

Perthmore Subdivision TIS  
 12: Wilson Street /Canadian tire Ent/Ext & HWY 7

2030 Total Traffic  
 PM Peak Hour



Lane Group	EBL	EBT	EBR	WBL	WBT	WBR	NBL	NBT	NBR	SBL	SBT	SBR
Turn Type	Perm	NA	Perm	pm+pt	NA	Perm	pm+pt	NA	Perm	Perm	NA	Perm
Protected Phases		2		1	6		3	8			4	
Permitted Phases	2		2	6		6	8		8	4		4
Detector Phase	2	2	2	1	6	6	3	8	8	4	4	4
Switch Phase												
Minimum Initial (s)	20.0	20.0	20.0	7.0	20.0	20.0	7.0	10.0	10.0	10.0	10.0	10.0
Minimum Split (s)	43.9	43.9	43.9	9.0	43.9	43.9	9.0	37.4	37.4	37.4	37.4	37.4
Total Split (s)	44.6	44.6	44.6	9.0	53.6	53.6	9.0	46.4	46.4	37.4	37.4	37.4
Total Split (%)	44.6%	44.6%	44.6%	9.0%	53.6%	53.6%	9.0%	46.4%	46.4%	37.4%	37.4%	37.4%
Maximum Green (s)	37.7	37.7	37.7	7.0	46.7	46.7	7.0	40.0	40.0	31.0	31.0	31.0
Yellow Time (s)	5.0	5.0	5.0	2.0	5.0	5.0	2.0	4.1	4.1	4.1	4.1	4.1
All-Red Time (s)	1.9	1.9	1.9	0.0	1.9	1.9	0.0	2.3	2.3	2.3	2.3	2.3
Lost Time Adjust (s)	0.0	0.0	0.0	0.0	0.0	0.0		0.0	0.0		0.0	0.0
Total Lost Time (s)	6.9	6.9	6.9	2.0	6.9	6.9		6.4	6.4		6.4	6.4
Lead/Lag	Lag	Lag	Lag	Lead			Lead			Lag	Lag	Lag
Lead-Lag Optimize?	Yes	Yes	Yes	Yes			Yes			Yes	Yes	Yes
Vehicle Extension (s)	4.5	4.5	4.5	2.0	4.5	4.5	2.0	3.0	3.0	3.0	3.0	3.0
Recall Mode	Min	Min	Min	None	Min	Min	None	None	None	None	None	None
Walk Time (s)	7.0	7.0	7.0		7.0	7.0		7.0	7.0	7.0	7.0	7.0
Flash Dont Walk (s)	30.0	30.0	30.0		30.0	30.0		24.0	24.0	24.0	24.0	24.0
Pedestrian Calls (#/hr)	0	0	0		0	0		3	3	0	0	0
Act Effct Green (s)	36.4	36.4	36.4	50.6	45.6	45.6		29.0	29.0		29.0	29.0
Actuated g/C Ratio	0.41	0.41	0.41	0.57	0.52	0.52		0.33	0.33		0.33	0.33
v/c Ratio	0.24	0.63	0.22	0.42	0.44	0.01		0.79	0.43		0.27	0.18
Control Delay	22.5	24.1	4.2	14.5	15.5	0.0		41.2	8.1		23.5	4.8
Queue Delay	0.0	0.0	0.0	0.0	0.0	0.0		0.0	0.0		0.0	0.0
Total Delay	22.5	24.1	4.2	14.5	15.5	0.0		41.2	8.1		23.5	4.8
LOS	C	C	A	B	B	A		D	A		C	A
Approach Delay		21.2			15.2			26.2			13.4	
Approach LOS		C			B			C			B	
Queue Length 50th (m)	7.6	65.2	0.0	10.6	43.9	0.0		53.0	8.2		12.4	0.0
Queue Length 95th (m)	18.5	90.0	9.7	23.7	69.6	0.0		59.1	12.5		24.5	10.5
Internal Link Dist (m)		431.2			299.0			454.2			538.7	
Turn Bay Length (m)	50.0		75.0	40.0		30.0						7.5
Base Capacity (vph)	293	1508	765	328	1851	896		580	808		410	683
Starvation Cap Reductn	0	0	0	0	0	0		0	0		0	0
Spillback Cap Reductn	0	0	0	0	0	0		0	0		0	0
Storage Cap Reductn	0	0	0	0	0	0		0	0		0	0
Reduced v/c Ratio	0.23	0.60	0.21	0.42	0.42	0.01		0.56	0.34		0.23	0.16

**Intersection Summary**

Area Type:	Other
Cycle Length:	100
Actuated Cycle Length:	88.1
Natural Cycle:	100
Control Type:	Semi Act-Uncoord
Maximum v/c Ratio:	0.79
Intersection Signal Delay:	19.7
Intersection Capacity Utilization	71.6%
Intersection LOS:	B
ICU Level of Service	C

Analysis Period (min) 15

Splits and Phases: 12: Wilson Street /Canadian tire Ent/Ext & HWY 7

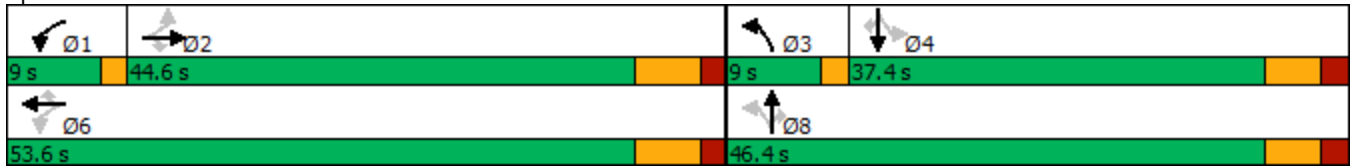

Perthmore Subdivision TIS  
 15: Drummond Street/Dufferin Street & HWY 7

2030 Total Traffic  
 PM Peak Hour



Lane Group	EBL	EBT	EBR	WBL	WBT	WBR	NBL	NBT	NBR	SBL	SBT	SBR
Lane Configurations												
Traffic Volume (vph)	69	539	348	142	495	5	259	20	126	14	24	69
Future Volume (vph)	69	539	348	142	495	5	259	20	126	14	24	69
Ideal Flow (vphpl)	1900	1900	1900	1900	1900	1900	1900	1900	1900	1900	1900	1900
Storage Length (m)	30.0		45.0	30.0		15.0	65.0		0.0	40.0		0.0
Storage Lanes	1		1	1		0	1		0	1		0
Taper Length (m)	7.5			7.5			0.0			20.0		
Lane Util. Factor	1.00	0.95	1.00	0.91	0.91	0.95	1.00	1.00	1.00	1.00	1.00	1.00
Ped Bike Factor							1.00	0.99		1.00	0.99	
Frt			0.850		0.999			0.871			0.888	
Flt Protected	0.950			0.950	0.999		0.950			0.950		
Satd. Flow (prot)	1770	3374	1615	1643	3292	0	1787	1606	0	1805	1647	0
Flt Permitted	0.437			0.286	0.938		0.456			0.652		
Satd. Flow (perm)	814	3374	1615	494	3091	0	857	1606	0	1236	1647	0
Right Turn on Red			Yes			Yes			Yes			Yes
Satd. Flow (RTOR)			430		1			143			90	
Link Speed (k/h)		60			60			50			50	
Link Distance (m)		323.0			147.4			376.3			222.4	
Travel Time (s)		19.4			8.8			27.1			16.0	
Confl. Peds. (#/hr)							1		3	3		1
Peak Hour Factor	0.81	0.81	0.81	0.94	0.94	0.94	0.88	0.88	0.88	0.77	0.77	0.77
Heavy Vehicles (%)	2%	7%	0%	0%	5%	0%	1%	0%	2%	0%	0%	2%
Adj. Flow (vph)	85	665	430	151	527	5	294	23	143	18	31	90
Shared Lane Traffic (%)				10%								
Lane Group Flow (vph)	85	665	430	136	547	0	294	166	0	18	121	0
Enter Blocked Intersection	No	No	No	No	No	No	No	No	No	No	No	No
Lane Alignment	Left	Left	Right	Left	Left	Right	Left	Left	Right	Left	Left	Right
Median Width(m)		3.6			3.6			3.6			3.6	
Link Offset(m)		0.0			0.0			0.0			0.0	
Crosswalk Width(m)		4.8			4.8			4.8			4.8	
Two way Left Turn Lane												
Headway Factor	1.00	1.00	1.00	1.00	1.00	1.00	1.00	1.00	1.00	1.00	1.00	1.00
Turning Speed (k/h)	25		15	25		15	25		15	25		15
Number of Detectors	1	1	1	1	2		1	1		1	1	
Detector Template	Left		Right	Left								
Leading Detector (m)	2.0	94.8	2.0	2.0	86.8		9.0	9.0		9.0	9.0	
Trailing Detector (m)	0.0	93.0	0.0	0.0	-1.0		-3.0	-3.0		-3.0	-3.0	
Detector 1 Position(m)	0.0	93.0	0.0	0.0	-1.0		-3.0	-3.0		-3.0	-3.0	
Detector 1 Size(m)	2.0	1.8	2.0	2.0	12.0		12.0	12.0		12.0	12.0	
Detector 1 Type	Cl+Ex	Cl+Ex	Cl+Ex	Cl+Ex	Cl+Ex		Cl+Ex	Cl+Ex		Cl+Ex	Cl+Ex	
Detector 1 Channel												
Detector 1 Extend (s)	0.0	0.0	0.0	0.0	0.0		0.0	0.0		0.0	0.0	
Detector 1 Queue (s)	0.0	0.0	0.0	0.0	0.0		0.0	0.0		0.0	0.0	
Detector 1 Delay (s)	0.0	0.0	0.0	0.0	0.0		0.0	0.0		0.0	0.0	
Detector 2 Position(m)					85.0							
Detector 2 Size(m)					1.8							
Detector 2 Type					Cl+Ex							
Detector 2 Channel												
Detector 2 Extend (s)					0.0							



Perthmore Subdivision TIS  
 15: Drummond Street/Dufferin Street & HWY 7

2030 Total Traffic  
 PM Peak Hour



Lane Group	EBL	EBT	EBR	WBL	WBT	WBR	NBL	NBT	NBR	SBL	SBT	SBR
Turn Type	Perm	NA	Perm	pm+pt	NA		pm+pt	NA		Perm	NA	
Protected Phases		2		1	6		3	8				4
Permitted Phases	2		2	6			8			4		
Detector Phase	2	2	2	1	6		3	8		4		4
Switch Phase												
Minimum Initial (s)	20.0	20.0	20.0	7.0	20.0		5.0	10.0		10.0		10.0
Minimum Split (s)	33.3	33.3	33.3	10.0	36.3		9.5	38.3		38.3		38.3
Total Split (s)	33.7	33.7	33.7	12.0	45.7		11.0	49.3		38.3		38.3
Total Split (%)	35.5%	35.5%	35.5%	12.6%	48.1%		11.6%	51.9%		40.3%		40.3%
Maximum Green (s)	27.4	27.4	27.4	9.0	39.4		6.5	43.0		32.0		32.0
Yellow Time (s)	5.0	5.0	5.0	3.0	5.0		3.5	4.1		4.1		4.1
All-Red Time (s)	1.3	1.3	1.3	0.0	1.3		1.0	2.2		2.2		2.2
Lost Time Adjust (s)	0.0	0.0	0.0	0.0	0.0		0.0	0.0		0.0		0.0
Total Lost Time (s)	6.3	6.3	6.3	3.0	6.3		4.5	6.3		6.3		6.3
Lead/Lag	Lag	Lag	Lag	Lead			Lead			Lag		Lag
Lead-Lag Optimize?	Yes	Yes	Yes	Yes			Yes			Yes		Yes
Vehicle Extension (s)	4.6	4.6	4.6	3.0	4.6		3.0	3.0		3.0		3.0
Recall Mode	Min	Min	Min	None	Min		None	None		None		None
Walk Time (s)	7.0	7.0	7.0		7.0			7.0		7.0		7.0
Flash Dont Walk (s)	20.0	20.0	20.0		20.0			25.0		25.0		25.0
Pedestrian Calls (#/hr)	0	0	0		0			1		0		0
Act Effct Green (s)	22.7	22.7	22.7	34.6	31.2		22.3	20.4		12.2		12.2
Actuated g/C Ratio	0.35	0.35	0.35	0.53	0.48		0.34	0.31		0.19		0.19
v/c Ratio	0.30	0.56	0.51	0.33	0.36		0.71	0.28		0.08		0.32
Control Delay	22.5	21.5	4.7	11.3	12.0		29.3	6.1		25.4		12.3
Queue Delay	0.0	0.0	0.0	0.0	0.0		0.0	0.0		0.0		0.0
Total Delay	22.5	21.5	4.7	11.3	12.0		29.3	6.1		25.4		12.3
LOS	C	C	A	B	B		C	A		C		B
Approach Delay		15.4			11.9			20.9				14.0
Approach LOS		B			B			C				B
Queue Length 50th (m)	8.2	37.6	0.0	8.7	22.0		28.2	2.0		2.0		3.4
Queue Length 95th (m)	20.5	58.4	11.9	23.7	43.3		#55.4	13.9		6.5		12.6
Internal Link Dist (m)		299.0			123.4			352.3				198.4
Turn Bay Length (m)	30.0		45.0	30.0			65.0			40.0		
Base Capacity (vph)	361	1497	956	431	1984		415	1159		640		897
Starvation Cap Reductn	0	0	0	0	0		0	0		0		0
Spillback Cap Reductn	0	0	0	0	0		0	0		0		0
Storage Cap Reductn	0	0	0	0	0		0	0		0		0
Reduced v/c Ratio	0.24	0.44	0.45	0.32	0.28		0.71	0.14		0.03		0.13

Intersection Summary

Area Type:	Other
Cycle Length:	95
Actuated Cycle Length:	64.8
Natural Cycle:	95
Control Type:	Semi Act-Uncoord
Maximum v/c Ratio:	0.71
Intersection Signal Delay:	15.4
Intersection Capacity Utilization	70.6%
Intersection LOS:	B
ICU Level of Service	C

Analysis Period (min) 15

# 95th percentile volume exceeds capacity, queue may be longer.

Queue shown is maximum after two cycles.

Splits and Phases: 15: Drummond Street/Dufferin Street & HWY 7

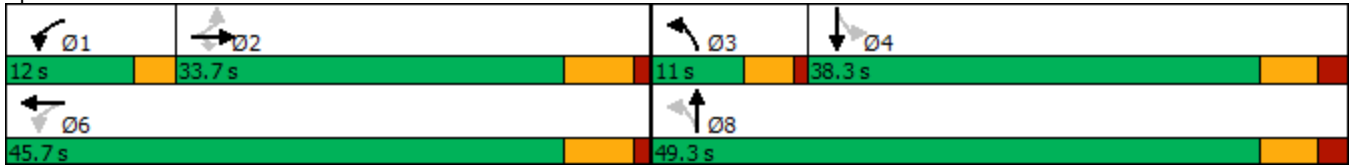

Perthmore Subdivision TIS  
26: Wilson Street & Sunset Boulevard

2030 Total Traffic  
PM Peak Hour



Lane Group	EBL	EBT	EBR	WBL	WBT	WBR	NBL	NBT	NBR	SBL	SBT	SBR
Lane Configurations		↕	↗		↕		↗	↖		↖	↕	↗
Traffic Volume (vph)	145	32	246	10	52	32	112	686	5	15	713	69
Future Volume (vph)	145	32	246	10	52	32	112	686	5	15	713	69
Ideal Flow (vphpl)	1900	1900	1900	1900	1900	1900	1900	1900	1900	1900	1900	1900
Storage Length (m)	0.0		0.0	0.0		0.0	15.0		0.0	25.0		0.0
Storage Lanes	0		1	0		0	1		0	1		1
Taper Length (m)	7.5			7.5			7.5			7.5		
Lane Util. Factor	1.00	1.00	1.00	1.00	1.00	1.00	1.00	1.00	1.00	1.00	1.00	1.00
Ped Bike Factor		0.98	0.95		0.99			1.00				0.91
Frt			0.850		0.954			0.999				0.850
Flt Protected		0.961			0.995		0.950			0.950		
Satd. Flow (prot)	0	1728	1583	0	1763	0	1770	1843	0	1805	1863	1615
Flt Permitted		0.741			0.959		0.137			0.157		
Satd. Flow (perm)	0	1312	1500	0	1694	0	255	1843	0	298	1863	1477
Right Turn on Red			Yes			Yes			Yes			Yes
Satd. Flow (RTOR)			228		42			1				113
Link Speed (k/h)		50			50			50				50
Link Distance (m)		238.8			244.8			341.7				184.4
Travel Time (s)		17.2			17.6			24.6				13.3
Confl. Peds. (#/hr)	23		20	20		23	40		18	18		40
Peak Hour Factor	0.93	0.93	0.93	0.77	0.77	0.77	0.87	0.87	0.87	0.83	0.83	0.83
Heavy Vehicles (%)	6%	4%	2%	0%	2%	0%	2%	3%	0%	0%	2%	0%
Adj. Flow (vph)	156	34	265	13	68	42	129	789	6	18	859	83
Shared Lane Traffic (%)												
Lane Group Flow (vph)	0	190	265	0	123	0	129	795	0	18	859	83
Enter Blocked Intersection	No	No	No	No	No	No	No	No	No	No	No	No
Lane Alignment	Left	Left	Right	Left	Left	Right	Left	Left	Right	Left	Left	Right
Median Width(m)		0.0			0.0			3.6			3.6	
Link Offset(m)		0.0			0.0			0.0			0.0	
Crosswalk Width(m)		4.8			4.8			4.8			4.8	
Two way Left Turn Lane												
Headway Factor	1.00	1.00	1.00	1.00	1.00	1.00	1.00	1.00	1.00	1.00	1.00	1.00
Turning Speed (k/h)	25		15	25		15	25		15	25		15
Number of Detectors	1	1	1	1	2		1	2		1	2	1
Detector Template	Left		Right	Left	Thru			Thru			Thru	Right
Leading Detector (m)	2.0	10.0	2.0	2.0	10.0		3.0	10.0		3.0	10.0	2.0
Trailing Detector (m)	0.0	5.0	0.0	0.0	0.0		-1.0	0.0		-1.0	0.0	0.0
Detector 1 Position(m)	0.0	5.0	0.0	0.0	0.0		-1.0	0.0		-1.0	0.0	0.0
Detector 1 Size(m)	2.0	5.0	2.0	2.0	0.6		4.0	0.6		4.0	0.6	2.0
Detector 1 Type	Cl+Ex	Cl+Ex	Cl+Ex	Cl+Ex	Cl+Ex		Cl+Ex	Cl+Ex		Cl+Ex	Cl+Ex	Cl+Ex
Detector 1 Channel												
Detector 1 Extend (s)	0.0	0.0	0.0	0.0	0.0		0.0	0.0		0.0	0.0	0.0
Detector 1 Queue (s)	0.0	0.0	0.0	0.0	0.0		0.0	0.0		0.0	0.0	0.0
Detector 1 Delay (s)	0.0	0.0	0.0	0.0	0.0		0.0	0.0		0.0	0.0	0.0
Detector 2 Position(m)					9.4			9.4			9.4	
Detector 2 Size(m)					0.6			0.6			0.6	
Detector 2 Type					Cl+Ex			Cl+Ex			Cl+Ex	
Detector 2 Channel												
Detector 2 Extend (s)					0.0			0.0			0.0	

Perthmore Subdivision TIS  
 26: Wilson Street & Sunset Boulevard

2030 Total Traffic  
 PM Peak Hour



Lane Group	EBL	EBT	EBR	WBL	WBT	WBR	NBL	NBT	NBR	SBL	SBT	SBR
Turn Type	Perm	NA	Perm	Perm	NA		pm+pt	NA		pm+pt	NA	Perm
Protected Phases		4			8		5	2		1	6	
Permitted Phases	4		4	8			2			6		6
Detector Phase	4	4	4	8	8		5	2		1	6	6
Switch Phase							2			6		
Minimum Initial (s)	10.0	10.0	10.0	10.0	10.0		5.0	10.0		5.0	10.0	10.0
Minimum Split (s)	22.6	22.6	22.6	22.6	22.6		9.6	22.6		9.6	22.6	22.6
Total Split (s)	22.6	22.6	22.6	22.6	22.6		9.6	27.8		9.6	27.8	27.8
Total Split (%)	37.7%	37.7%	37.7%	37.7%	37.7%		16.0%	46.3%		16.0%	46.3%	46.3%
Maximum Green (s)	18.0	18.0	18.0	18.0	18.0		5.0	23.2		5.0	23.2	23.2
Yellow Time (s)	3.3	3.3	3.3	3.3	3.3		3.3	3.3		3.3	3.3	3.3
All-Red Time (s)	1.3	1.3	1.3	1.3	1.3		1.3	1.3		1.3	1.3	1.3
Lost Time Adjust (s)		0.0	0.0		0.0		0.0	0.0		0.0	0.0	0.0
Total Lost Time (s)		4.6	4.6		4.6		4.6	4.6		4.6	4.6	4.6
Lead/Lag							Lead	Lag		Lead	Lag	Lag
Lead-Lag Optimize?							Yes	Yes		Yes	Yes	Yes
Vehicle Extension (s)	3.0	3.0	3.0	3.0	3.0		3.0	3.0		3.0	3.0	3.0
Recall Mode	None	None	None	None	None		None	Min		None	Min	Min
Walk Time (s)	7.0	7.0	7.0	7.0	7.0			7.0			7.0	7.0
Flash Dont Walk (s)	11.0	11.0	11.0	11.0	11.0			11.0			11.0	11.0
Pedestrian Calls (#/hr)	15	15	15	33	33			18			18	18
Act Effct Green (s)		13.7	13.7		13.7		30.1	29.2		27.4	23.6	23.6
Actuated g/C Ratio		0.25	0.25		0.25		0.56	0.54		0.51	0.44	0.44
v/c Ratio		0.57	0.48		0.27		0.45	0.80		0.06	1.05	0.12
Control Delay		25.7	7.4		13.3		12.6	21.6		6.7	68.7	2.2
Queue Delay		0.0	0.0		0.0		0.0	0.0		0.0	0.0	0.0
Total Delay		25.7	7.4		13.3		12.6	21.6		6.7	68.7	2.2
LOS		C	A		B		B	C		A	E	A
Approach Delay		15.1			13.3			20.3			61.8	
Approach LOS		B			B			C			E	
Queue Length 50th (m)		17.8	3.0		6.8		4.9	49.7		0.7	~105.0	0.0
Queue Length 95th (m)		35.1	18.2		14.3		14.4	#163.8		2.9	#165.1	3.7
Internal Link Dist (m)		214.8			220.8			317.7			160.4	
Turn Bay Length (m)							15.0			25.0		
Base Capacity (vph)		445	659		602		285	997		293	815	709
Starvation Cap Reductn		0	0		0		0	0		0	0	0
Spillback Cap Reductn		0	0		0		0	0		0	0	0
Storage Cap Reductn		0	0		0		0	0		0	0	0
Reduced v/c Ratio		0.43	0.40		0.20		0.45	0.80		0.06	1.05	0.12

Intersection Summary

Area Type:	Other
Cycle Length:	60
Actuated Cycle Length:	53.9
Natural Cycle:	75
Control Type:	Semi Act-Uncoord
Maximum v/c Ratio:	1.05
Intersection Signal Delay:	35.2
Intersection Capacity Utilization	78.1%
Intersection LOS:	D
ICU Level of Service	D

Analysis Period (min) 15

~ Volume exceeds capacity, queue is theoretically infinite.

Queue shown is maximum after two cycles.

# 95th percentile volume exceeds capacity, queue may be longer.

Queue shown is maximum after two cycles.

Splits and Phases: 26: Wilson Street & Sunset Boulevard

↙ Ø1	↑ Ø2	↘ Ø4
9.6 s	27.8 s	22.6 s
↙ Ø5	↓ Ø6	← Ø8
9.6 s	27.8 s	22.6 s

Perthmore Subdivision TIS  
 30: Wilson Street & Leslie Street/Isabella Street

2030 Total Traffic  
 PM Peak Hour



Lane Group	EBL	EBT	EBR	WBL	WBT	WBR	NBL	NBT	NBR	SBL	SBT	SBR
Lane Configurations		↕			↕		↕	↕		↕	↕	
Traffic Volume (vph)	129	27	6	33	31	81	3	641	4	44	742	51
Future Volume (vph)	129	27	6	33	31	81	3	641	4	44	742	51
Ideal Flow (vphpl)	1900	1900	1900	1900	1900	1900	1900	1900	1900	1900	1900	1900
Storage Length (m)	0.0		0.0	0.0		0.0	60.0		0.0	25.0		0.0
Storage Lanes	0		0	0		0	1		0	1		0
Taper Length (m)	7.5			7.5			25.0			15.0		
Lane Util. Factor	1.00	1.00	1.00	1.00	1.00	1.00	1.00	1.00	1.00	1.00	1.00	1.00
Ped Bike Factor		0.99			0.98			1.00		1.00	0.99	
Frt		0.995			0.925			0.999			0.990	
Flt Protected		0.962			0.989		0.950			0.950		
Satd. Flow (prot)	0	1772	0	0	1707	0	1805	1843	0	1703	1820	0
Flt Permitted		0.650			0.915		0.122			0.251		
Satd. Flow (perm)	0	1190	0	0	1572	0	232	1843	0	448	1820	0
Right Turn on Red			Yes			Yes			Yes			Yes
Satd. Flow (RTOR)		3			90			1			8	
Link Speed (k/h)		50			50			50			50	
Link Distance (m)		224.9			415.9			340.1			341.7	
Travel Time (s)		16.2			29.9			24.5			24.6	
Confl. Peds. (#/hr)	4		13	13		4	36		9	9		36
Peak Hour Factor	0.76	0.76	0.76	0.90	0.90	0.90	0.96	0.96	0.96	0.85	0.85	0.85
Heavy Vehicles (%)	3%	0%	0%	0%	0%	0%	0%	3%	0%	6%	3%	0%
Adj. Flow (vph)	170	36	8	37	34	90	3	668	4	52	873	60
Shared Lane Traffic (%)												
Lane Group Flow (vph)	0	214	0	0	161	0	3	672	0	52	933	0
Enter Blocked Intersection	No	No	No	No	No	No	No	No	No	No	No	No
Lane Alignment	Left	Left	Right	Left	Left	Right	Left	Left	Right	Left	Left	Right
Median Width(m)		0.0			0.0			3.6			3.6	
Link Offset(m)		0.0			0.0			0.0			0.0	
Crosswalk Width(m)		4.8			4.8			4.8			4.8	
Two way Left Turn Lane												
Headway Factor	1.00	1.00	1.00	1.00	1.00	1.00	1.00	1.00	1.00	1.00	1.00	1.00
Turning Speed (k/h)	25		15	25		15	25		15	25		15
Number of Detectors	1	2		1	2		1	2		1	2	
Detector Template	Left	Thru		Left	Thru		Left	Thru		Left	Thru	
Leading Detector (m)	2.0	10.0		2.0	10.0		2.0	10.0		2.0	10.0	
Trailing Detector (m)	0.0	0.0		0.0	0.0		0.0	0.0		0.0	0.0	
Detector 1 Position(m)	0.0	0.0		0.0	0.0		0.0	0.0		0.0	0.0	
Detector 1 Size(m)	2.0	0.6		2.0	0.6		2.0	0.6		2.0	0.6	
Detector 1 Type	Cl+Ex	Cl+Ex		Cl+Ex	Cl+Ex		Cl+Ex	Cl+Ex		Cl+Ex	Cl+Ex	
Detector 1 Channel												
Detector 1 Extend (s)	0.0	0.0		0.0	0.0		0.0	0.0		0.0	0.0	
Detector 1 Queue (s)	0.0	0.0		0.0	0.0		0.0	0.0		0.0	0.0	
Detector 1 Delay (s)	0.0	0.0		0.0	0.0		0.0	0.0		0.0	0.0	
Detector 2 Position(m)		9.4			9.4			9.4			9.4	
Detector 2 Size(m)		0.6			0.6			0.6			0.6	
Detector 2 Type		Cl+Ex			Cl+Ex			Cl+Ex			Cl+Ex	
Detector 2 Channel												
Detector 2 Extend (s)		0.0			0.0			0.0			0.0	

Perthmore Subdivision TIS  
 30: Wilson Street & Leslie Street/Isabella Street

2030 Total Traffic  
 PM Peak Hour



Lane Group	EBL	EBT	EBR	WBL	WBT	WBR	NBL	NBT	NBR	SBL	SBT	SBR
Turn Type	Perm	NA		Perm	NA		pm+pt	NA		pm+pt	NA	
Protected Phases		4			8		5	2		1	6	
Permitted Phases	4			8			2			6		
Detector Phase	4	4		8	8		5	2		1	6	
Switch Phase							2			6		
Minimum Initial (s)	10.0	10.0		10.0	10.0		5.0	10.0		5.0	10.0	
Minimum Split (s)	15.0	15.0		15.0	15.0		9.6	35.0		9.6	35.0	
Total Split (s)	15.0	15.0		15.0	15.0		9.6	35.4		9.6	35.4	
Total Split (%)	25.0%	25.0%		25.0%	25.0%		16.0%	59.0%		16.0%	59.0%	
Maximum Green (s)	10.4	10.4		10.4	10.4		5.0	30.8		5.0	30.8	
Yellow Time (s)	3.3	3.3		3.3	3.3		3.3	3.3		3.3	3.3	
All-Red Time (s)	1.3	1.3		1.3	1.3		1.3	1.3		1.3	1.3	
Lost Time Adjust (s)		0.0			0.0		0.0	0.0		0.0	0.0	
Total Lost Time (s)		4.6			4.6		4.6	4.6		4.6	4.6	
Lead/Lag							Lead	Lag		Lead	Lag	
Lead-Lag Optimize?							Yes	Yes		Yes	Yes	
Vehicle Extension (s)	3.0	3.0		3.0	3.0		3.0	3.0		3.0	3.0	
Recall Mode	None	None		None	None		None	Min		None	Min	
Walk Time (s)	5.0	5.0		5.0	5.0			7.0			7.0	
Flash Dont Walk (s)	5.0	5.0		5.0	5.0			11.0			11.0	
Pedestrian Calls (#/hr)	9	9		4	4			13			28	
Act Effct Green (s)		10.5			10.5		34.0	31.0		35.8	34.9	
Actuated g/C Ratio		0.19			0.19		0.60	0.55		0.63	0.62	
v/c Ratio		0.96			0.44		0.01	0.66		0.13	0.83	
Control Delay		80.8			14.9		3.7	14.2		4.3	18.7	
Queue Delay		0.0			0.0		0.0	0.0		0.0	0.0	
Total Delay		80.8			14.9		3.7	14.2		4.3	18.7	
LOS		F			B		A	B		A	B	
Approach Delay		80.8			14.9			14.2			18.0	
Approach LOS		F			B			B			B	
Queue Length 50th (m)		21.3			6.2		0.1	54.5		1.6	57.2	
Queue Length 95th (m)		#50.2			22.5		0.7	91.1		4.0	#164.3	
Internal Link Dist (m)		200.9			391.9			316.1			317.7	
Turn Bay Length (m)							60.0			25.0		
Base Capacity (vph)		222			364		279	1065		396	1129	
Starvation Cap Reductn		0			0		0	0		0	0	
Spillback Cap Reductn		0			0		0	0		0	0	
Storage Cap Reductn		0			0		0	0		0	0	
Reduced v/c Ratio		0.96			0.44		0.01	0.63		0.13	0.83	

Intersection Summary

Area Type:	Other
Cycle Length:	60
Actuated Cycle Length:	56.4
Natural Cycle:	90
Control Type:	Semi Act-Uncoord
Maximum v/c Ratio:	0.96
Intersection Signal Delay:	23.1
Intersection Capacity Utilization	65.7%
Intersection LOS:	C
ICU Level of Service	C

Analysis Period (min) 15

# 95th percentile volume exceeds capacity, queue may be longer.

Queue shown is maximum after two cycles.

Splits and Phases: 30: Wilson Street & Leslie Street/Isabella Street





Perthmore Subdivision TIS  
3: Drummond Concession 2 & Perthmore

2030 Total Traffic  
PM Peak Hour

Intersection						
Int Delay, s/veh	2.2					
Movement	EBL	EBT	WBT	WBR	SBL	SBR
Lane Configurations		↕	↑	↗	↘	
Traffic Vol, veh/h	59	232	170	28	10	49
Future Vol, veh/h	59	232	170	28	10	49
Conflicting Peds, #/hr	0	0	0	0	0	0
Sign Control	Free	Free	Free	Free	Stop	Stop
RT Channelized	-	None	-	None	-	None
Storage Length	-	-	-	25	0	-
Veh in Median Storage, #	-	0	0	-	0	-
Grade, %	-	0	0	-	0	-
Peak Hour Factor	85	85	83	83	68	68
Heavy Vehicles, %	20	2	0	0	25	0
Mvmt Flow	69	273	205	34	15	72

Major/Minor	Major1	Major2	Minor2		
Conflicting Flow All	239	0	0	616	205
Stage 1	-	-	-	205	-
Stage 2	-	-	-	411	-
Critical Hdwy	4.3	-	-	6.65	6.2
Critical Hdwy Stg 1	-	-	-	5.65	-
Critical Hdwy Stg 2	-	-	-	5.65	-
Follow-up Hdwy	2.38	-	-	3.725	3.3
Pot Cap-1 Maneuver	1229	-	-	419	841
Stage 1	-	-	-	777	-
Stage 2	-	-	-	622	-
Platoon blocked, %	-	-	-	-	-
Mov Cap-1 Maneuver	1229	-	-	391	841
Mov Cap-2 Maneuver	-	-	-	391	-
Stage 1	-	-	-	726	-
Stage 2	-	-	-	622	-

Approach	EB	WB	SB
HCM Control Delay, s	1.6	0	10.8
HCM LOS			B

Minor Lane/Major Mvmt	EBL	EBT	WBT	WBR	SBLn1
Capacity (veh/h)	1229	-	-	-	704
HCM Lane V/C Ratio	0.056	-	-	-	0.123
HCM Control Delay (s)	8.1	0	-	-	10.8
HCM Lane LOS	A	A	-	-	B
HCM 95th %tile Q(veh)	0.2	-	-	-	0.4

Intersection						
Int Delay, s/veh	1.9					
Movement	EBT	EBR	WBL	WBT	NBL	NBR
Lane Configurations						
Traffic Vol, veh/h	80	13	22	92	10	19
Future Vol, veh/h	80	13	22	92	10	19
Conflicting Peds, #/hr	0	0	0	0	1	9
Sign Control	Free	Free	Free	Free	Stop	Stop
RT Channelized	-	None	-	None	-	None
Storage Length	-	-	-	-	0	-
Veh in Median Storage, #	0	-	-	0	0	-
Grade, %	0	-	-	0	0	-
Peak Hour Factor	78	78	72	72	75	75
Heavy Vehicles, %	2	0	0	1	0	10
Mvmt Flow	103	17	31	128	13	25

Major/Minor	Major1	Major2	Minor1		
Conflicting Flow All	0	0	120	0	303
Stage 1	-	-	-	-	112
Stage 2	-	-	-	-	191
Critical Hdwy	-	-	4.1	-	6.4
Critical Hdwy Stg 1	-	-	-	-	5.4
Critical Hdwy Stg 2	-	-	-	-	5.4
Follow-up Hdwy	-	-	2.2	-	3.5
Pot Cap-1 Maneuver	-	-	1480	-	693
Stage 1	-	-	-	-	918
Stage 2	-	-	-	-	846
Platoon blocked, %	-	-	-	-	-
Mov Cap-1 Maneuver	-	-	1480	-	676
Mov Cap-2 Maneuver	-	-	-	-	676
Stage 1	-	-	-	-	918
Stage 2	-	-	-	-	826

Approach	EB	WB	NB
HCM Control Delay, s	0	1.4	9.7
HCM LOS			A

Minor Lane/Major Mvmt	NBLn1	EBT	EBR	WBL	WBT
Capacity (veh/h)	809	-	-	1480	-
HCM Lane V/C Ratio	0.048	-	-	0.021	-
HCM Control Delay (s)	9.7	-	-	7.5	0
HCM Lane LOS	A	-	-	A	A
HCM 95th %tile Q(veh)	0.1	-	-	0.1	-

Perthmore Subdivision TIS  
34: Wilson Street & North Street

2030 Total Traffic  
PM Peak Hour

Intersection												
Int Delay, s/veh	6.9											
Movement	EBL	EBT	EBR	WBL	WBT	WBR	NBL	NBT	NBR	SBL	SBT	SBR
Lane Configurations		↕			↕			↕			↕	
Traffic Vol, veh/h	6	5	13	15	10	134	12	494	32	153	581	29
Future Vol, veh/h	6	5	13	15	10	134	12	494	32	153	581	29
Conflicting Peds, #/hr	5	0	9	9	0	5	20	0	19	19	0	20
Sign Control	Stop	Stop	Stop	Stop	Stop	Stop	Free	Free	Free	Free	Free	Free
RT Channelized	-	-	None	-	-	None	-	-	None	-	-	None
Storage Length	-	-	-	-	-	-	-	-	-	-	-	65
Veh in Median Storage, #	-	0	-	-	0	-	-	0	-	-	0	-
Grade, %	-	0	-	-	0	-	-	0	-	-	0	-
Peak Hour Factor	68	68	68	94	94	94	89	89	89	96	96	96
Heavy Vehicles, %	20	0	0	0	0	7	0	1	0	12	1	0
Mvmt Flow	9	7	19	16	11	143	13	555	36	159	605	30

Major/Minor	Minor2		Minor1		Major1			Major2				
Conflicting Flow All	1639	1594	347	1251	1591	597	655	0	0	610	0	0
Stage 1	958	958	-	618	618	-	-	-	-	-	-	-
Stage 2	681	636	-	633	973	-	-	-	-	-	-	-
Critical Hdwy	7.6	6.5	6.9	7.3	6.5	6.305	4.1	-	-	4.28	-	-
Critical Hdwy Stg 1	6.8	5.5	-	6.1	5.5	-	-	-	-	-	-	-
Critical Hdwy Stg 2	6.4	5.5	-	6.5	5.5	-	-	-	-	-	-	-
Follow-up Hdwy	3.69	4	3.3	3.5	4.3	3.665	2.2	-	-	2.314	-	-
Pot Cap-1 Maneuver	63	108	655	141	108	490	942	-	-	911	-	-
Stage 1	251	338	-	480	484	-	-	-	-	-	-	-
Stage 2	404	475	-	439	333	-	-	-	-	-	-	-
Platoon blocked, %								-	-	-	-	-
Mov Cap-1 Maneuver	30	74	639	96	74	480	926	-	-	896	-	-
Mov Cap-2 Maneuver	30	74	-	96	74	-	-	-	-	-	-	-
Stage 1	241	241	-	462	466	-	-	-	-	-	-	-
Stage 2	271	457	-	297	237	-	-	-	-	-	-	-

Approach	EB		WB		NB		SB	
HCM Control Delay, s	77.2		35.9		0.2		2.7	
HCM LOS	F		E					

Minor Lane/Major Mvmt	NBL	NBT	NBR	EBLn1	WBLn1	SBL	SBT	SBR
Capacity (veh/h)	926	-	-	83	279	896	-	-
HCM Lane V/C Ratio	0.015	-	-	0.425	0.606	0.178	-	-
HCM Control Delay (s)	8.9	0	-	77.2	35.9	9.9	0.9	-
HCM Lane LOS	A	A	-	F	E	A	A	-
HCM 95th %tile Q(veh)	0	-	-	1.7	3.6	0.6	-	-

Perthmore Subdivision TIS  
7: Drummond Street & North Street

2030 Total Traffic  
PM Peak Hour

Intersection	
Intersection Delay, s/veh	63.8
Intersection LOS	F

Movement	EBL	EBT	EBR	WBL	WBT	WBR	NBL	NBT	NBR	SBL	SBT	SBR
Lane Configurations		↕			↕			↕			↕	
Traffic Vol, veh/h	14	110	15	65	106	140	19	321	62	152	292	14
Future Vol, veh/h	14	110	15	65	106	140	19	321	62	152	292	14
Peak Hour Factor	0.85	0.85	0.85	0.85	0.85	0.85	0.89	0.89	0.89	0.85	0.85	0.85
Heavy Vehicles, %	0	6	0	0	5	1	0	0	0	0	0	0
Mvmt Flow	16	129	18	76	125	165	21	361	70	179	344	16
Number of Lanes	0	1	0	0	1	0	0	1	0	0	1	0

Approach	EB	WB	NB	SB
Opposing Approach	WB	EB	SB	NB
Opposing Lanes	1	1	1	1
Conflicting Approach Left	SB	NB	EB	WB
Conflicting Lanes Left	1	1	1	1
Conflicting Approach Right	NB	SB	WB	EB
Conflicting Lanes Right	1	1	1	1
HCM Control Delay	18.3	34.1	53.7	106.3
HCM LOS	C	D	F	F

Lane	NBLn1	EBLn1	WBLn1	SBLn1
Vol Left, %	5%	10%	21%	33%
Vol Thru, %	80%	79%	34%	64%
Vol Right, %	15%	11%	45%	3%
Sign Control	Stop	Stop	Stop	Stop
Traffic Vol by Lane	402	139	311	458
LT Vol	19	14	65	152
Through Vol	321	110	106	292
RT Vol	62	15	140	14
Lane Flow Rate	452	164	366	539
Geometry Grp	1	1	1	1
Degree of Util (X)	0.928	0.398	0.779	1.124
Departure Headway (Hd)	7.754	9.279	8.05	7.508
Convergence, Y/N	Yes	Yes	Yes	Yes
Cap	470	391	454	485
Service Time	5.754	7.279	6.05	5.568
HCM Lane V/C Ratio	0.962	0.419	0.806	1.111
HCM Control Delay	53.7	18.3	34.1	106.3
HCM Lane LOS	F	C	D	F
HCM 95th-tile Q	10.8	1.9	6.8	18.3

Perthmore Subdivision TIS  
 12: Wilson Street /Canadian tire Ent/Ext & HWY 7

2035 Total Traffic  
 AM Peak Hour



Lane Group	EBL	EBT	EBR	WBL	WBT	WBR	NBL	NBT	NBR	SBL	SBT	SBR
Lane Configurations												
Traffic Volume (vph)	80	550	315	251	689	14	391	80	256	55	78	122
Future Volume (vph)	80	550	315	251	689	14	391	80	256	55	78	122
Ideal Flow (vphpl)	1900	1900	1900	1900	1900	1900	1900	1900	1900	1900	1900	1900
Storage Length (m)	50.0		75.0	40.0		30.0	0.0		0.0	0.0		7.5
Storage Lanes	1		1	1		1	0		1	0		1
Taper Length (m)	7.5			7.5			7.5			10.0		
Lane Util. Factor	1.00	0.95	1.00	1.00	0.95	1.00	1.00	1.00	1.00	1.00	1.00	1.00
Ped Bike Factor									0.99		1.00	
Fr <sub>t</sub>			0.850			0.850			0.850			0.850
Fl <sub>t</sub> Protected	0.950			0.950				0.960			0.980	
Satd. Flow (prot)	1805	3505	1553	1805	3406	1538	0	1765	1509	0	1782	1583
Fl <sub>t</sub> Permitted	0.379			0.325				0.666			0.551	
Satd. Flow (perm)	720	3505	1553	618	3406	1538	0	1225	1488	0	1002	1583
Right Turn on Red			Yes			Yes			Yes			Yes
Satd. Flow (RTOR)			346			59			272			93
Link Speed (k/h)		60			60			50			50	
Link Distance (m)		455.2			323.0			474.1			562.7	
Travel Time (s)		27.3			19.4			34.1			40.5	
Confl. Peds. (#/hr)									2	2		
Peak Hour Factor	0.91	0.91	0.91	0.96	0.96	0.96	0.94	0.94	0.94	0.92	0.92	0.92
Heavy Vehicles (%)	0%	3%	4%	0%	6%	5%	4%	0%	7%	8%	2%	2%
Adj. Flow (vph)	88	604	346	261	718	15	416	85	272	60	85	133
Shared Lane Traffic (%)												
Lane Group Flow (vph)	88	604	346	261	718	15	0	501	272	0	145	133
Enter Blocked Intersection	No	No	No	No	No	No	No	No	No	No	No	No
Lane Alignment	Left	Left	Right	Left	Left	Right	Left	Left	Right	Left	Left	Right
Median Width(m)		3.6			3.6			0.0			0.0	
Link Offset(m)		0.0			0.0			0.0			0.0	
Crosswalk Width(m)		4.8			4.8			4.8			4.8	
Two way Left Turn Lane												
Headway Factor	1.00	1.00	1.00	1.00	1.00	1.00	1.00	1.00	1.00	1.00	1.00	1.00
Turning Speed (k/h)	25		15	25		15	25		15	25		15
Number of Detectors	1	2	1	1	2	1	1	1	1	1	1	1
Detector Template	Left		Right	Left		Right	Left			Left		
Leading Detector (m)	2.0	98.8	2.0	2.0	91.8	2.0	2.0	9.0	9.0	2.0	9.0	9.0
Trailing Detector (m)	0.0	-3.0	0.0	0.0	-3.0	0.0	0.0	-3.0	-3.0	0.0	-0.2	-3.0
Detector 1 Position(m)	0.0	-3.0	0.0	0.0	-3.0	0.0	0.0	-3.0	-3.0	0.0	-0.2	-3.0
Detector 1 Size(m)	2.0	12.0	2.0	2.0	12.0	2.0	2.0	12.0	12.0	2.0	9.2	12.0
Detector 1 Type	Cl+Ex	Cl+Ex	Cl+Ex	Cl+Ex	Cl+Ex	Cl+Ex	Cl+Ex	Cl+Ex	Cl+Ex	Cl+Ex	Cl+Ex	Cl+Ex
Detector 1 Channel												
Detector 1 Extend (s)	0.0	0.0	0.0	0.0	0.0	0.0	0.0	0.0	0.0	0.0	0.0	0.0
Detector 1 Queue (s)	0.0	0.0	0.0	0.0	0.0	0.0	0.0	0.0	0.0	0.0	0.0	0.0
Detector 1 Delay (s)	0.0	0.0	0.0	0.0	0.0	0.0	0.0	0.0	0.0	0.0	0.0	0.0
Detector 2 Position(m)		97.0			90.0							
Detector 2 Size(m)		1.8			1.8							
Detector 2 Type		Cl+Ex			Cl+Ex							
Detector 2 Channel												
Detector 2 Extend (s)		0.0			0.0							

Perthmore Subdivision TIS  
 12: Wilson Street /Canadian tire Ent/Ext & HWY 7

2035 Total Traffic  
 AM Peak Hour



Lane Group	EBL	EBT	EBR	WBL	WBT	WBR	NBL	NBT	NBR	SBL	SBT	SBR
Turn Type	Perm	NA	Perm	pm+pt	NA	Perm	pm+pt	NA	Perm	Perm	NA	Perm
Protected Phases		2		1	6		3	8			4	
Permitted Phases	2		2	6		6	8		8	4		4
Detector Phase	2	2	2	1	6	6	3	8	8	4	4	4
Switch Phase												
Minimum Initial (s)	20.0	20.0	20.0	7.0	2.0	2.0	7.0	10.0	10.0	10.0	10.0	10.0
Minimum Split (s)	43.9	43.9	43.9	9.0	43.9	43.9	9.0	37.4	37.4	37.4	37.4	37.4
Total Split (s)	44.4	44.4	44.4	9.0	53.4	53.4	9.0	46.6	46.6	37.6	37.6	37.6
Total Split (%)	44.4%	44.4%	44.4%	9.0%	53.4%	53.4%	9.0%	46.6%	46.6%	37.6%	37.6%	37.6%
Maximum Green (s)	37.5	37.5	37.5	7.0	46.5	46.5	7.0	40.2	40.2	31.2	31.2	31.2
Yellow Time (s)	5.0	5.0	5.0	2.0	5.0	5.0	2.0	4.1	4.1	4.1	4.1	4.1
All-Red Time (s)	1.9	1.9	1.9	0.0	1.9	1.9	0.0	2.3	2.3	2.3	2.3	2.3
Lost Time Adjust (s)	0.0	0.0	0.0	0.0	0.0	0.0		0.0	0.0		0.0	0.0
Total Lost Time (s)	6.9	6.9	6.9	2.0	6.9	6.9		6.4	6.4		6.4	6.4
Lead/Lag	Lag	Lag	Lag	Lead			Lead			Lag	Lag	Lag
Lead-Lag Optimize?	Yes	Yes	Yes	Yes			Yes			Yes	Yes	Yes
Vehicle Extension (s)	4.5	4.5	4.5	2.0	4.5	4.5	2.0	3.0	3.0	3.0	3.0	3.0
Recall Mode	Min	Min	Min	None	Min	Min	None	None	None	None	None	None
Walk Time (s)	7.0	7.0	7.0		7.0	7.0		7.0	7.0	7.0	7.0	7.0
Flash Dont Walk (s)	30.0	30.0	30.0		30.0	30.0		24.0	24.0	24.0	24.0	24.0
Pedestrian Calls (#/hr)	0	0	0		0	0		1	1	0	0	0
Act Effct Green (s)	34.8	34.8	34.8	48.7	43.8	43.8		40.3	40.3		40.3	40.3
Actuated g/C Ratio	0.36	0.36	0.36	0.50	0.45	0.45		0.41	0.41		0.41	0.41
v/c Ratio	0.34	0.48	0.45	0.66	0.47	0.02		0.99	0.35		0.35	0.19
Control Delay	27.1	25.6	4.4	24.1	19.7	0.1		68.7	3.8		23.7	7.8
Queue Delay	0.0	0.0	0.0	0.0	0.0	0.0		0.0	0.0		0.0	0.0
Total Delay	27.1	25.6	4.4	24.1	19.7	0.1		68.7	3.8		23.7	7.8
LOS	C	C	A	C	B	A		E	A		C	A
Approach Delay		18.7			20.6			45.9			16.1	
Approach LOS		B			C			D			B	
Queue Length 50th (m)	12.6	48.3	0.0	28.9	50.5	0.0		~104.5	0.0		20.3	4.9
Queue Length 95th (m)	26.5	64.3	18.0	45.2	66.3	0.0		#172.4	15.6		37.4	16.8
Internal Link Dist (m)		431.2			299.0			450.1			538.7	
Turn Bay Length (m)	50.0		75.0	40.0		30.0						7.5
Base Capacity (vph)	278	1352	811	394	1629	766		506	774		414	708
Starvation Cap Reductn	0	0	0	0	0	0		0	0		0	0
Spillback Cap Reductn	0	0	0	0	0	0		0	0		0	0
Storage Cap Reductn	0	0	0	0	0	0		0	0		0	0
Reduced v/c Ratio	0.32	0.45	0.43	0.66	0.44	0.02		0.99	0.35		0.35	0.19

**Intersection Summary**

Area Type:	Other
Cycle Length:	100
Actuated Cycle Length:	97.5
Natural Cycle:	100
Control Type:	Semi Act-Uncoord
Maximum v/c Ratio:	0.99
Intersection Signal Delay:	25.9
Intersection Capacity Utilization	85.1%
Intersection LOS:	C
ICU Level of Service	E

Analysis Period (min) 15

~ Volume exceeds capacity, queue is theoretically infinite.

Queue shown is maximum after two cycles.

# 95th percentile volume exceeds capacity, queue may be longer.

Queue shown is maximum after two cycles.

Splits and Phases: 12: Wilson Street /Canadian tire Ent/Ext & HWY 7

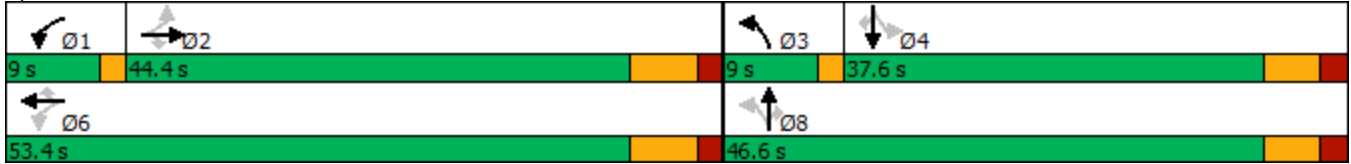

Perthmore Subdivision TIS  
 15: Drummond Street/Dufferin Street & HWY 7

2035 Total Traffic  
 AM Peak Hour



Lane Group	EBL	EBT	EBR	WBL	WBT	WBR	NBL	NBT	NBR	SBL	SBT	SBR
Lane Configurations												
Traffic Volume (vph)	98	423	245	139	592	23	297	68	147	19	65	113
Future Volume (vph)	98	423	245	139	592	23	297	68	147	19	65	113
Ideal Flow (vphpl)	1900	1900	1900	1900	1900	1900	1900	1900	1900	1900	1900	1900
Storage Length (m)	30.0		45.0	30.0		15.0	65.0		0.0	40.0		0.0
Storage Lanes	1		1	1		0	1		0	1		0
Taper Length (m)	7.5			7.5			0.0			20.0		
Lane Util. Factor	1.00	0.95	1.00	1.00	0.95	0.95	1.00	1.00	1.00	1.00	1.00	1.00
Ped Bike Factor								0.99		1.00		
Frt			0.850		0.994			0.897				0.905
Flt Protected	0.950			0.950			0.950			0.950		
Satd. Flow (prot)	1736	3374	1583	1752	3287	0	1770	1655	0	1671	1678	0
Flt Permitted	0.392			0.416			0.350			0.606		
Satd. Flow (perm)	716	3374	1583	767	3287	0	652	1655	0	1065	1678	0
Right Turn on Red			Yes			Yes			Yes			Yes
Satd. Flow (RTOR)			269		5			156				100
Link Speed (k/h)		60			60			50				50
Link Distance (m)		323.0			147.8			376.3				173.7
Travel Time (s)		19.4			8.9			27.1				12.5
Confl. Peds. (#/hr)									2	2		
Peak Hour Factor	0.91	0.91	0.91	0.90	0.90	0.90	0.87	0.87	0.87	0.77	0.77	0.77
Heavy Vehicles (%)	4%	7%	2%	3%	9%	13%	2%	2%	2%	8%	5%	1%
Adj. Flow (vph)	108	465	269	154	658	26	341	78	169	25	84	147
Shared Lane Traffic (%)												
Lane Group Flow (vph)	108	465	269	154	684	0	341	247	0	25	231	0
Enter Blocked Intersection	No	No	No	No	No	No	No	No	No	No	No	No
Lane Alignment	Left	Left	Right	Left	Left	Right	Left	Left	Right	Left	Left	Right
Median Width(m)		3.6			3.6			3.6				3.6
Link Offset(m)		0.0			0.0			0.0				0.0
Crosswalk Width(m)		4.8			4.8			4.8				4.8
Two way Left Turn Lane												
Headway Factor	1.00	1.00	1.00	1.00	1.00	1.00	1.00	1.00	1.00	1.00	1.00	1.00
Turning Speed (k/h)	25		15	25		15	25		15	25		15
Number of Detectors	1	1	1	1	2		1	1		1	1	
Detector Template	Left		Right	Left								
Leading Detector (m)	2.0	94.8	2.0	2.0	86.8		9.0	9.0		9.0	9.0	
Trailing Detector (m)	0.0	93.0	0.0	0.0	-1.0		-3.0	-3.0		-3.0	-3.0	
Detector 1 Position(m)	0.0	93.0	0.0	0.0	-1.0		-3.0	-3.0		-3.0	-3.0	
Detector 1 Size(m)	2.0	1.8	2.0	2.0	12.0		12.0	12.0		12.0	12.0	
Detector 1 Type	Cl+Ex	Cl+Ex	Cl+Ex	Cl+Ex	Cl+Ex		Cl+Ex	Cl+Ex		Cl+Ex	Cl+Ex	
Detector 1 Channel												
Detector 1 Extend (s)	0.0	0.0	0.0	0.0	0.0		0.0	0.0		0.0	0.0	
Detector 1 Queue (s)	0.0	0.0	0.0	0.0	0.0		0.0	0.0		0.0	0.0	
Detector 1 Delay (s)	0.0	0.0	0.0	0.0	0.0		0.0	0.0		0.0	0.0	
Detector 2 Position(m)					85.0							
Detector 2 Size(m)					1.8							
Detector 2 Type					Cl+Ex							
Detector 2 Channel												
Detector 2 Extend (s)					0.0							



Perthmore Subdivision TIS  
 15: Drummond Street/Dufferin Street & HWY 7

2035 Total Traffic  
 AM Peak Hour



Lane Group	EBL	EBT	EBR	WBL	WBT	WBR	NBL	NBT	NBR	SBL	SBT	SBR
Turn Type	Perm	NA	Perm	pm+pt	NA		pm+pt	NA		Perm	NA	
Protected Phases		2		1	6		3	8				4
Permitted Phases	2		2	6			8			4		
Detector Phase	2	2	2	1	6		3	8		4		4
Switch Phase												
Minimum Initial (s)	20.0	20.0	20.0	7.0	20.0		5.0	10.0		10.0		10.0
Minimum Split (s)	33.3	33.3	33.3	10.0	36.3		9.5	38.3		38.3		38.3
Total Split (s)	33.7	33.7	33.7	10.0	43.7		13.0	51.3		38.3		38.3
Total Split (%)	35.5%	35.5%	35.5%	10.5%	46.0%		13.7%	54.0%		40.3%		40.3%
Maximum Green (s)	27.4	27.4	27.4	7.0	37.4		8.5	45.0		32.0		32.0
Yellow Time (s)	5.0	5.0	5.0	3.0	5.0		3.5	4.1		4.1		4.1
All-Red Time (s)	1.3	1.3	1.3	0.0	1.3		1.0	2.2		2.2		2.2
Lost Time Adjust (s)	0.0	0.0	0.0	0.0	0.0		0.0	0.0		0.0		0.0
Total Lost Time (s)	6.3	6.3	6.3	3.0	6.3		4.5	6.3		6.3		6.3
Lead/Lag	Lag	Lag	Lag	Lead			Lead			Lag		Lag
Lead-Lag Optimize?	Yes	Yes	Yes	Yes			Yes			Yes		Yes
Vehicle Extension (s)	4.6	4.6	4.6	3.0	4.6		3.0	3.0		3.0		3.0
Recall Mode	Max	Max	Max	None	Max		None	None		None		None
Walk Time (s)	7.0	7.0	7.0		7.0			7.0		7.0		7.0
Flash Dont Walk (s)	20.0	20.0	20.0		20.0			25.0		25.0		25.0
Pedestrian Calls (#/hr)	0	0	0		0			1		0		0
Act Effct Green (s)	27.5	27.5	27.5	40.8	37.5		27.7	25.9		12.9		12.9
Actuated g/C Ratio	0.36	0.36	0.36	0.54	0.49		0.36	0.34		0.17		0.17
v/c Ratio	0.42	0.38	0.36	0.31	0.42		0.94	0.37		0.14		0.63
Control Delay	25.6	19.7	4.2	11.5	13.7		57.9	8.8		28.1		24.4
Queue Delay	0.0	0.0	0.0	0.0	0.0		0.0	0.0		0.0		0.0
Total Delay	25.6	19.7	4.2	11.5	13.7		57.9	8.8		28.1		24.4
LOS	C	B	A	B	B		E	A		C		C
Approach Delay		15.5			13.3			37.3				24.8
Approach LOS		B			B			D				C
Queue Length 50th (m)	11.7	26.1	0.0	10.5	31.4		39.7	9.4		3.2		18.0
Queue Length 95th (m)	29.8	44.0	15.8	24.0	53.3		#79.5	23.4		8.2		30.3
Internal Link Dist (m)		299.0			123.8			352.3				149.7
Turn Bay Length (m)	30.0		45.0	30.0			65.0			40.0		
Base Capacity (vph)	258	1219	743	502	1623		362	1045		449		765
Starvation Cap Reductn	0	0	0	0	0		0	0		0		0
Spillback Cap Reductn	0	0	0	0	0		0	0		0		0
Storage Cap Reductn	0	0	0	0	0		0	0		0		0
Reduced v/c Ratio	0.42	0.38	0.36	0.31	0.42		0.94	0.24		0.06		0.30

Intersection Summary

Area Type:	Other
Cycle Length:	95
Actuated Cycle Length:	76
Natural Cycle:	95
Control Type:	Semi Act-Uncoord
Maximum v/c Ratio:	0.94
Intersection Signal Delay:	20.8
Intersection Capacity Utilization	80.1%
Intersection LOS:	C
ICU Level of Service	D

Analysis Period (min) 15

# 95th percentile volume exceeds capacity, queue may be longer.

Queue shown is maximum after two cycles.

Splits and Phases: 15: Drummond Street/Dufferin Street & HWY 7

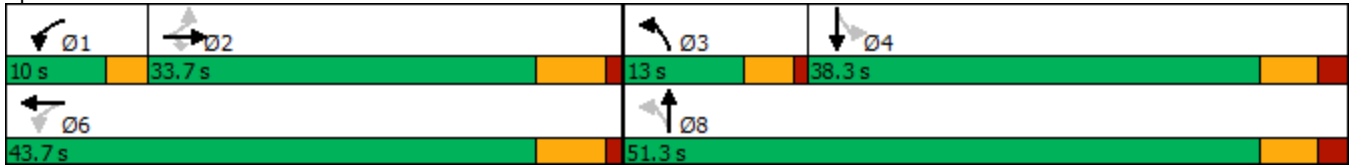

Perthmore Subdivision TIS  
 26: Wilson Street & Sunset Boulevard

2035 Total Traffic  
 AM Peak Hour



Lane Group	EBL	EBT	EBR	WBL	WBT	WBR	NBL	NBT	NBR	SBL	SBT	SBR
Lane Configurations		↖	↗		↔		↖	↗		↖	↗	↖
Traffic Volume (vph)	107	17	204	13	54	22	135	450	0	6	525	67
Future Volume (vph)	107	17	204	13	54	22	135	450	0	6	525	67
Ideal Flow (vphpl)	1900	1900	1900	1900	1900	1900	1900	1900	1900	1900	1900	1900
Storage Length (m)	0.0		0.0	0.0		0.0	15.0		0.0	25.0		0.0
Storage Lanes	0		1	0		0	1		0	1		1
Taper Length (m)	7.5			7.5			7.5			7.5		
Lane Util. Factor	1.00	1.00	1.00	1.00	1.00	1.00	1.00	1.00	1.00	1.00	1.00	1.00
Ped Bike Factor		0.98	0.97		0.99		0.99			1.00		0.93
Frt			0.850		0.967							0.850
Flt Protected		0.959			0.993		0.950			0.950		
Satd. Flow (prot)	0	1704	1524	0	1773	0	1787	1792	0	1805	1810	1583
Flt Permitted		0.715			0.937		0.189			0.370		
Satd. Flow (perm)	0	1245	1483	0	1672	0	351	1792	0	701	1810	1477
Right Turn on Red			Yes			Yes			Yes			Yes
Satd. Flow (RTOR)			284		28							113
Link Speed (k/h)		50			50			50				50
Link Distance (m)		147.8			117.2			341.7				188.6
Travel Time (s)		10.6			8.4			24.6				13.6
Confl. Peds. (#/hr)	30		4	4		30	29		6	6		29
Peak Hour Factor	0.55	0.55	0.55	0.64	0.64	0.64	0.85	0.85	0.85	0.86	0.86	0.86
Heavy Vehicles (%)	8%	0%	6%	0%	3%	0%	1%	6%	0%	0%	5%	2%
Adj. Flow (vph)	195	31	371	20	84	34	159	529	0	7	610	78
Shared Lane Traffic (%)												
Lane Group Flow (vph)	0	226	371	0	138	0	159	529	0	7	610	78
Enter Blocked Intersection	No	No	No	No	No	No	No	No	No	No	No	No
Lane Alignment	Left	Left	Right	Left	Left	Right	Left	Left	Right	Left	Left	Right
Median Width(m)		0.0			0.0			3.6				3.6
Link Offset(m)		0.0			0.0			0.0				0.0
Crosswalk Width(m)		4.8			4.8			4.8				4.8
Two way Left Turn Lane												
Headway Factor	1.00	1.00	1.00	1.00	1.00	1.00	1.00	1.00	1.00	1.00	1.00	1.00
Turning Speed (k/h)	25		15	25		15	25		15	25		15
Number of Detectors	1	1	1	1	2		1	2		1	2	1
Detector Template	Left		Right	Left	Thru			Thru			Thru	Right
Leading Detector (m)	2.0	10.0	2.0	2.0	10.0		5.0	10.0		5.0	10.0	2.0
Trailing Detector (m)	0.0	5.0	0.0	0.0	0.0		-1.0	0.0		-1.0	0.0	0.0
Detector 1 Position(m)	0.0	5.0	0.0	0.0	0.0		-1.0	0.0		-1.0	0.0	0.0
Detector 1 Size(m)	2.0	5.0	2.0	2.0	0.6		6.0	0.6		6.0	0.6	2.0
Detector 1 Type	Cl+Ex	Cl+Ex	Cl+Ex	Cl+Ex	Cl+Ex		Cl+Ex	Cl+Ex		Cl+Ex	Cl+Ex	Cl+Ex
Detector 1 Channel												
Detector 1 Extend (s)	0.0	0.0	0.0	0.0	0.0		0.0	0.0		0.0	0.0	0.0
Detector 1 Queue (s)	0.0	0.0	0.0	0.0	0.0		0.0	0.0		0.0	0.0	0.0
Detector 1 Delay (s)	0.0	0.0	0.0	0.0	0.0		0.0	0.0		0.0	0.0	0.0
Detector 2 Position(m)					9.4			9.4				9.4
Detector 2 Size(m)					0.6			0.6				0.6
Detector 2 Type					Cl+Ex			Cl+Ex				Cl+Ex
Detector 2 Channel												
Detector 2 Extend (s)					0.0			0.0				0.0

Perthmore Subdivision TIS  
 26: Wilson Street & Sunset Boulevard

2035 Total Traffic  
 AM Peak Hour



Lane Group	EBL	EBT	EBR	WBL	WBT	WBR	NBL	NBT	NBR	SBL	SBT	SBR
Turn Type	Perm	NA	Perm	Perm	NA		pm+pt	NA		pm+pt	NA	Perm
Protected Phases		4			8		5	2		1	6	
Permitted Phases	4		4	8			2			6		6
Detector Phase	4	4	4	8	8		5	2		1	6	6
Switch Phase							2			6		
Minimum Initial (s)	10.0	10.0	10.0	10.0	10.0		5.0	10.0		5.0	10.0	10.0
Minimum Split (s)	22.6	22.6	22.6	22.6	22.6		9.6	22.6		9.6	22.6	22.6
Total Split (s)	22.6	22.6	22.6	22.6	22.6		9.6	27.8		9.6	27.8	27.8
Total Split (%)	37.7%	37.7%	37.7%	37.7%	37.7%		16.0%	46.3%		16.0%	46.3%	46.3%
Maximum Green (s)	18.0	18.0	18.0	18.0	18.0		5.0	23.2		5.0	23.2	23.2
Yellow Time (s)	3.3	3.3	3.3	3.3	3.3		3.3	3.3		3.3	3.3	3.3
All-Red Time (s)	1.3	1.3	1.3	1.3	1.3		1.3	1.3		1.3	1.3	1.3
Lost Time Adjust (s)		0.0	0.0		0.0		0.0	0.0		0.0	0.0	0.0
Total Lost Time (s)		4.6	4.6		4.6		4.6	4.6		4.6	4.6	4.6
Lead/Lag							Lead	Lag		Lead	Lag	Lag
Lead-Lag Optimize?							Yes	Yes		Yes	Yes	Yes
Vehicle Extension (s)	3.0	3.0	3.0	3.0	3.0		3.0	3.0		3.0	3.0	3.0
Recall Mode	None	None	None	None	None		None	Min		None	Min	Min
Walk Time (s)	7.0	7.0	7.0	7.0	7.0			7.0			7.0	7.0
Flash Dont Walk (s)	11.0	11.0	11.0	11.0	11.0			11.0			11.0	11.0
Pedestrian Calls (#/hr)	6	6	6	22	22			22			4	4
Act Effct Green (s)		14.8	14.8		14.8		27.1	26.2		24.5	20.9	20.9
Actuated g/C Ratio		0.28	0.28		0.28		0.52	0.50		0.47	0.40	0.40
v/c Ratio		0.65	0.60		0.28		0.49	0.59		0.02	0.85	0.12
Control Delay		27.9	9.5		15.2		12.1	14.6		6.3	29.7	2.0
Queue Delay		0.0	0.0		0.0		0.0	0.0		0.0	0.0	0.0
Total Delay		27.9	9.5		15.2		12.1	14.6		6.3	29.7	2.0
LOS		C	A		B		B	B		A	C	A
Approach Delay		16.5			15.2			14.1			26.4	
Approach LOS		B			B			B			C	
Queue Length 50th (m)		22.1	7.4		9.4		7.2	30.9		0.4	57.6	0.0
Queue Length 95th (m)		22.6	4.6		13.8		15.1	#79.7		1.7	#111.1	3.6
Internal Link Dist (m)		123.8			93.2			317.7			164.6	
Turn Bay Length (m)							15.0			25.0		
Base Capacity (vph)		451	719		624		326	1007		439	846	751
Starvation Cap Reductn		0	0		0		0	0		0	0	0
Spillback Cap Reductn		0	0		0		0	0		0	0	0
Storage Cap Reductn		0	0		0		0	0		0	0	0
Reduced v/c Ratio		0.50	0.52		0.22		0.49	0.53		0.02	0.72	0.10

Intersection Summary	
Area Type:	Other
Cycle Length:	60
Actuated Cycle Length:	52.4
Natural Cycle:	60
Control Type:	Semi Act-Uncoord
Maximum v/c Ratio:	0.85
Intersection Signal Delay:	18.9
Intersection Capacity Utilization	65.0%
Intersection LOS:	B
ICU Level of Service	C

Analysis Period (min) 15

# 95th percentile volume exceeds capacity, queue may be longer.

Queue shown is maximum after two cycles.

Splits and Phases: 26: Wilson Street & Sunset Boulevard

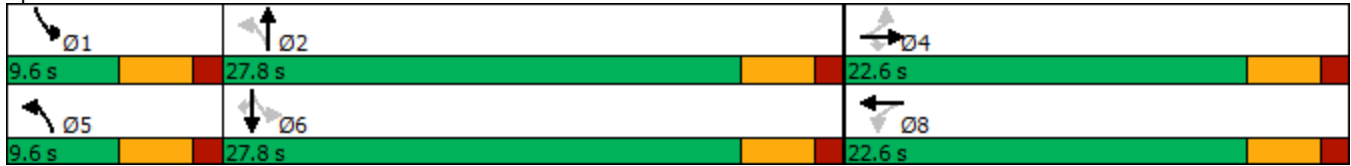

Perthmore Subdivision TIS  
 30: Wilson Street & Leslie Street/Isabella Street

2035 Total Traffic  
 AM Peak Hour



Lane Group	EBL	EBT	EBR	WBL	WBT	WBR	NBL	NBT	NBR	SBL	SBT	SBR
Lane Configurations		↕			↕		↗	↘		↗	↘	
Traffic Volume (vph)	30	12	3	20	10	68	0	474	3	49	584	32
Future Volume (vph)	30	12	3	20	10	68	0	474	3	49	584	32
Ideal Flow (vphpl)	1900	1900	1900	1900	1900	1900	1900	1900	1900	1900	1900	1900
Storage Length (m)	0.0		0.0	0.0		0.0	60.0		0.0	25.0		0.0
Storage Lanes	0		0	0		0	1		0	1		0
Taper Length (m)	7.5			7.5			25.0			15.0		
Lane Util. Factor	1.00	1.00	1.00	1.00	1.00	1.00	1.00	1.00	1.00	1.00	1.00	1.00
Ped Bike Factor		0.97			0.94			1.00		0.99	1.00	
Frt		0.991			0.907			0.999			0.992	
Flt Protected		0.968			0.990					0.950		
Satd. Flow (prot)	0	1522	0	0	1542	0	1900	1758	0	1752	1745	0
Flt Permitted		0.785			0.914					0.281		
Satd. Flow (perm)	0	1196	0	0	1420	0	1900	1758	0	514	1745	0
Right Turn on Red			Yes			Yes			Yes			Yes
Satd. Flow (RTOR)		4			94			1			7	
Link Speed (k/h)		50			50			50			50	
Link Distance (m)		91.6			415.9			340.1			341.7	
Travel Time (s)		6.6			29.9			24.5			24.6	
Confl. Peds. (#/hr)	23		4	4		23	6		16	16		6
Peak Hour Factor	0.78	0.78	0.78	0.72	0.72	0.72	0.82	0.82	0.82	0.82	0.82	0.82
Heavy Vehicles (%)	24%	0%	50%	0%	14%	4%	0%	8%	0%	3%	7%	23%
Adj. Flow (vph)	38	15	4	28	14	94	0	578	4	60	712	39
Shared Lane Traffic (%)												
Lane Group Flow (vph)	0	57	0	0	136	0	0	582	0	60	751	0
Enter Blocked Intersection	No	No	No	No	No	No	No	No	No	No	No	No
Lane Alignment	Left	Left	Right	Left	Left	Right	Left	Left	Right	Left	Left	Right
Median Width(m)		0.0			0.0			3.6			3.6	
Link Offset(m)		0.0			0.0			0.0			0.0	
Crosswalk Width(m)		4.8			4.8			4.8			4.8	
Two way Left Turn Lane												
Headway Factor	1.00	1.00	1.00	1.00	1.00	1.00	1.00	1.00	1.00	1.00	1.00	1.00
Turning Speed (k/h)	25		15	25		15	25		15	25		15
Number of Detectors	1	2		1	2		1	2		1	2	
Detector Template	Left	Thru		Left	Thru		Left	Thru		Left	Thru	
Leading Detector (m)	2.0	10.0		2.0	10.0		2.0	10.0		2.0	10.0	
Trailing Detector (m)	0.0	0.0		0.0	0.0		0.0	0.0		0.0	0.0	
Detector 1 Position(m)	0.0	0.0		0.0	0.0		0.0	0.0		0.0	0.0	
Detector 1 Size(m)	2.0	0.6		2.0	0.6		2.0	0.6		2.0	0.6	
Detector 1 Type	Cl+Ex	Cl+Ex		Cl+Ex	Cl+Ex		Cl+Ex	Cl+Ex		Cl+Ex	Cl+Ex	
Detector 1 Channel												
Detector 1 Extend (s)	0.0	0.0		0.0	0.0		0.0	0.0		0.0	0.0	
Detector 1 Queue (s)	0.0	0.0		0.0	0.0		0.0	0.0		0.0	0.0	
Detector 1 Delay (s)	0.0	0.0		0.0	0.0		0.0	0.0		0.0	0.0	
Detector 2 Position(m)		9.4			9.4			9.4			9.4	
Detector 2 Size(m)		0.6			0.6			0.6			0.6	
Detector 2 Type		Cl+Ex			Cl+Ex			Cl+Ex			Cl+Ex	
Detector 2 Channel												
Detector 2 Extend (s)		0.0			0.0			0.0			0.0	

Perthmore Subdivision TIS  
30: Wilson Street & Leslie Street/Isabella Street

2035 Total Traffic  
AM Peak Hour



Lane Group	EBL	EBT	EBR	WBL	WBT	WBR	NBL	NBT	NBR	SBL	SBT	SBR
Turn Type	Perm	NA		Perm	NA		pm+pt	NA		pm+pt	NA	
Protected Phases		4			8		5	2		1	6	
Permitted Phases	4			8			2			6		
Detector Phase	4	4		8	8		5	2		1	6	
Switch Phase							2			6		
Minimum Initial (s)	10.0	10.0		10.0	10.0		5.0	10.0		5.0	10.0	
Minimum Split (s)	15.1	15.1		15.1	15.1		9.6	35.0		9.6	35.0	
Total Split (s)	15.1	15.1		15.1	15.1		9.6	35.3		9.6	35.3	
Total Split (%)	25.2%	25.2%		25.2%	25.2%		16.0%	58.8%		16.0%	58.8%	
Maximum Green (s)	10.5	10.5		10.5	10.5		5.0	30.7		5.0	30.7	
Yellow Time (s)	3.3	3.3		3.3	3.3		3.3	3.3		3.3	3.3	
All-Red Time (s)	1.3	1.3		1.3	1.3		1.3	1.3		1.3	1.3	
Lost Time Adjust (s)		0.0			0.0		0.0	0.0		0.0	0.0	
Total Lost Time (s)		4.6			4.6		4.6	4.6		4.6	4.6	
Lead/Lag							Lead	Lag		Lead	Lag	
Lead-Lag Optimize?							Yes	Yes		Yes	Yes	
Vehicle Extension (s)	3.0	3.0		3.0	3.0		3.0	3.0		3.0	3.0	
Recall Mode	None	None		None	None		None	Min		None	Min	
Walk Time (s)	6.0	6.0		6.0	6.0			7.0			7.0	
Flash Dont Walk (s)	4.5	4.5		4.5	4.5			11.0			11.0	
Pedestrian Calls (#/hr)	16	16		6	6			20			4	
Act Effct Green (s)		10.7			10.7			27.8		31.3	32.8	
Actuated g/C Ratio		0.23			0.23			0.59		0.66	0.69	
v/c Ratio		0.21			0.34			0.56		0.12	0.62	
Control Delay		20.8			11.8			12.6		4.2	8.5	
Queue Delay		0.0			0.0			0.0		0.0	0.0	
Total Delay		20.8			11.8			12.6		4.2	8.5	
LOS		C			B			B		A	A	
Approach Delay		20.8			11.8			12.6			8.2	
Approach LOS		C			B			B			A	
Queue Length 50th (m)		4.2			3.2			44.0		1.8	38.2	
Queue Length 95th (m)		12.3			11.7			64.5		4.3	56.5	
Internal Link Dist (m)		67.6			391.9			316.1			317.7	
Turn Bay Length (m)										25.0		
Base Capacity (vph)		286			408			1204		480	1285	
Starvation Cap Reductn		0			0			0		0	0	
Spillback Cap Reductn		0			0			0		0	0	
Storage Cap Reductn		0			0			0		0	0	
Reduced v/c Ratio		0.20			0.33			0.48		0.13	0.58	

Intersection Summary

Area Type:	Other
Cycle Length:	60
Actuated Cycle Length:	47.2
Natural Cycle:	60
Control Type:	Semi Act-Uncoord
Maximum v/c Ratio:	0.62
Intersection Signal Delay:	10.6
Intersection Capacity Utilization	56.9%
Intersection LOS:	B
ICU Level of Service	B

Analysis Period (min) 15

Splits and Phases: 30: Wilson Street & Leslie Street/Isabella Street





Intersection	
Intersection Delay, s/veh	49
Intersection LOS	E

Movement	EBL	EBT	EBR	WBL	WBT	WBR	NBL	NBT	NBR	SBL	SBT	SBR
Lane Configurations		↕			↕			↕			↕	
Traffic Vol, veh/h	13	110	13	79	118	114	4	251	48	120	282	20
Future Vol, veh/h	13	110	13	79	118	114	4	251	48	120	282	20
Peak Hour Factor	0.67	0.67	0.67	0.88	0.88	0.88	0.90	0.90	0.90	0.78	0.78	0.78
Heavy Vehicles, %	0	16	0	0	14	0	0	2	3	1	3	7
Mvmt Flow	19	164	19	90	134	130	4	279	53	154	362	26
Number of Lanes	0	1	0	0	1	0	0	1	0	0	1	0

Approach	EB	WB	NB	SB
Opposing Approach	WB	EB	SB	NB
Opposing Lanes	1	1	1	1
Conflicting Approach Left	SB	NB	EB	WB
Conflicting Lanes Left	1	1	1	1
Conflicting Approach Right	NB	SB	WB	EB
Conflicting Lanes Right	1	1	1	1
HCM Control Delay	18.3	28.3	25.7	88.6
HCM LOS	C	D	D	F

Lane	NBLn1	EBLn1	WBLn1	SBLn1
Vol Left, %	1%	10%	25%	28%
Vol Thru, %	83%	81%	38%	67%
Vol Right, %	16%	10%	37%	5%
Sign Control	Stop	Stop	Stop	Stop
Traffic Vol by Lane	303	136	311	422
LT Vol	4	13	79	120
Through Vol	251	110	118	282
RT Vol	48	13	114	20
Lane Flow Rate	337	203	353	541
Geometry Grp	1	1	1	1
Degree of Util (X)	0.685	0.454	0.722	1.076
Departure Headway (Hd)	7.669	8.468	7.715	7.162
Convergence, Y/N	Yes	Yes	Yes	Yes
Cap	475	428	474	509
Service Time	5.669	6.468	5.715	5.162
HCM Lane V/C Ratio	0.709	0.474	0.745	1.063
HCM Control Delay	25.7	18.3	28.3	88.6
HCM Lane LOS	D	C	D	F
HCM 95th-tile Q	5.1	2.3	5.8	16.8

Perthmore Subdivision TIS  
 3: Drummond Concession 2 & Perthmore

2035 Total Traffic  
 AM Peak Hour

Intersection						
Int Delay, s/veh	2.4					
Movement	EBL	EBT	WBT	WBR	SBL	SBR
Lane Configurations		↕	↑	↗	↘	
Traffic Vol, veh/h	27	144	220	8	19	57
Future Vol, veh/h	27	144	220	8	19	57
Conflicting Peds, #/hr	0	0	0	0	0	0
Sign Control	Free	Free	Free	Free	Stop	Stop
RT Channelized	-	None	-	None	-	None
Storage Length	-	-	-	25	0	-
Veh in Median Storage, #	-	0	0	-	0	-
Grade, %	-	0	0	-	0	-
Peak Hour Factor	83	83	84	84	78	78
Heavy Vehicles, %	50	9	1	25	0	12
Mvmt Flow	33	173	262	10	24	73

Major/Minor	Major1	Major2	Minor2		
Conflicting Flow All	272	0	-	0	501 262
Stage 1	-	-	-	-	262 -
Stage 2	-	-	-	-	239 -
Critical Hdwy	4.6	-	-	-	6.4 6.32
Critical Hdwy Stg 1	-	-	-	-	5.4 -
Critical Hdwy Stg 2	-	-	-	-	5.4 -
Follow-up Hdwy	2.65	-	-	-	3.5 3.408
Pot Cap-1 Maneuver	1059	-	-	-	533 753
Stage 1	-	-	-	-	786 -
Stage 2	-	-	-	-	805 -
Platoon blocked, %		-	-	-	
Mov Cap-1 Maneuver	1059	-	-	-	515 753
Mov Cap-2 Maneuver	-	-	-	-	515 -
Stage 1	-	-	-	-	759 -
Stage 2	-	-	-	-	805 -

Approach	EB	WB	SB
HCM Control Delay, s	1.3	0	11.2
HCM LOS			B

Minor Lane/Major Mvmt	EBL	EBT	WBT	WBR	SBLn1
Capacity (veh/h)	1059	-	-	-	675
HCM Lane V/C Ratio	0.031	-	-	-	0.144
HCM Control Delay (s)	8.5	0	-	-	11.2
HCM Lane LOS	A	A	-	-	B
HCM 95th %tile Q(veh)	0.1	-	-	-	0.5

Intersection						
Int Delay, s/veh	6.2					
Movement	EBT	EBR	WBL	WBT	NBL	NBR
Lane Configurations						
Traffic Vol, veh/h	71	103	23	58	88	21
Future Vol, veh/h	71	103	23	58	88	21
Conflicting Peds, #/hr	0	0	0	0	0	28
Sign Control	Free	Free	Free	Free	Stop	Stop
RT Channelized	-	None	-	None	-	None
Storage Length	-	-	-	-	0	-
Veh in Median Storage, #	0	-	-	0	0	-
Grade, %	0	-	-	0	0	-
Peak Hour Factor	63	63	68	68	41	41
Heavy Vehicles, %	2	25	17	8	3	15
Mvmt Flow	113	163	34	85	215	51

Major/Minor	Major1	Major2	Minor1		
Conflicting Flow All	0	0	276	0	348 223
Stage 1	-	-	-	-	195 -
Stage 2	-	-	-	-	153 -
Critical Hdwy	-	-	4.27	-	6.43 6.35
Critical Hdwy Stg 1	-	-	-	-	5.43 -
Critical Hdwy Stg 2	-	-	-	-	5.43 -
Follow-up Hdwy	-	-	2.353	-	3.527 3.435
Pot Cap-1 Maneuver	-	-	1205	-	647 785
Stage 1	-	-	-	-	836 -
Stage 2	-	-	-	-	873 -
Platoon blocked, %	-	-	-	-	-
Mov Cap-1 Maneuver	-	-	1205	-	628 766
Mov Cap-2 Maneuver	-	-	-	-	628 -
Stage 1	-	-	-	-	836 -
Stage 2	-	-	-	-	847 -

Approach	EB	WB	NB
HCM Control Delay, s	0	2.3	14.3
HCM LOS			B

Minor Lane/Major Mvmt	NBLn1	EBT	EBR	WBL	WBT
Capacity (veh/h)	651	-	-	1205	-
HCM Lane V/C Ratio	0.408	-	-	0.028	-
HCM Control Delay (s)	14.3	-	-	8.1	0
HCM Lane LOS	B	-	-	A	A
HCM 95th %tile Q(veh)	2	-	-	0.1	-

Perthmore Subdivision TIS  
 34: Wilson Street & North Street

2035 Total Traffic  
 AM Peak Hour

Intersection												
Int Delay, s/veh	4.3											
Movement	EBL	EBT	EBR	WBL	WBT	WBR	NBL	NBT	NBR	SBL	SBT	SBR
Lane Configurations		↕			↕			↕			↕	
Traffic Vol, veh/h	7	6	12	12	4	92	7	410	13	94	498	23
Future Vol, veh/h	7	6	12	12	4	92	7	410	13	94	498	23
Conflicting Peds, #/hr	3	0	3	3	0	3	13	0	10	10	0	13
Sign Control	Stop	Stop	Stop	Stop	Stop	Stop	Free	Free	Free	Free	Free	Free
RT Channelized	-	-	None	-	-	None	-	-	None	-	-	None
Storage Length	-	-	-	-	-	-	-	-	-	-	-	65
Veh in Median Storage, #	-	0	-	-	0	-	-	0	-	-	0	-
Grade, %	-	0	-	-	0	-	-	0	-	-	0	-
Peak Hour Factor	71	71	71	77	77	77	89	89	89	79	79	79
Heavy Vehicles, %	20	0	0	0	0	28	0	6	0	29	2	25
Mvmt Flow	10	8	17	16	5	119	8	461	15	119	630	29

Major/Minor	Minor2		Minor1		Major1			Major2				
Conflicting Flow All	1446	1398	346	1055	1405	482	672	0	0	486	0	0
Stage 1	896	896	-	495	495	-	-	-	-	-	-	-
Stage 2	550	502	-	560	910	-	-	-	-	-	-	-
Critical Hdwy	7.6	6.5	6.9	7.3	6.5	6.62	4.1	-	-	4.535	-	-
Critical Hdwy Stg 1	6.8	5.5	-	6.1	5.5	-	-	-	-	-	-	-
Critical Hdwy Stg 2	6.4	5.5	-	6.5	5.5	-	-	-	-	-	-	-
Follow-up Hdwy	3.69	4	3.3	3.5	4	3.566	2.2	-	-	2.4755	-	-
Pot Cap-1 Maneuver	88	142	656	194	141	523	928	-	-	927	-	-
Stage 1	274	362	-	560	549	-	-	-	-	-	-	-
Stage 2	480	545	-	485	356	-	-	-	-	-	-	-
Platoon blocked, %								-	-	-	-	-
Mov Cap-1 Maneuver	54	109	647	147	109	517	918	-	-	919	-	-
Mov Cap-2 Maneuver	54	109	-	147	109	-	-	-	-	-	-	-
Stage 1	268	285	-	549	538	-	-	-	-	-	-	-
Stage 2	360	534	-	363	280	-	-	-	-	-	-	-

Approach	EB		WB		NB		SB	
HCM Control Delay, s	45.6		20.9		0.1		2	
HCM LOS	E		C					

Minor Lane/Major Mvmt	NBL	NBT	NBR	EBLn1WBLn1	SBL	SBT	SBR
Capacity (veh/h)	918	-	-	123	365	919	-
HCM Lane V/C Ratio	0.009	-	-	0.286	0.384	0.129	-
HCM Control Delay (s)	9	0	-	45.6	20.9	9.5	0.7
HCM Lane LOS	A	A	-	E	C	A	A
HCM 95th %tile Q(veh)	0	-	-	1.1	1.8	0.4	-

Perthmore Subdivision TIS  
 12: Wilson Street /Canadian tire Ent/Ext & HWY 7

2035 Total Conditions  
 PM Peak Hour



Lane Group	EBL	EBT	EBR	WBL	WBT	WBR	NBL	NBT	NBR	SBL	SBT	SBR
Lane Configurations												
Traffic Volume (vph)	62	834	147	135	770	10	227	32	216	70	29	116
Future Volume (vph)	62	834	147	135	770	10	227	32	216	70	29	116
Ideal Flow (vphpl)	1900	1900	1900	1900	1900	1900	1900	1900	1900	1900	1900	1900
Storage Length (m)	50.0		75.0	45.0		30.0	0.0		0.0	0.0		7.5
Storage Lanes	1		1	1		1	0		1	0		1
Taper Length (m)	7.5			7.5			7.5			10.0		
Lane Util. Factor	1.00	0.95	1.00	1.00	0.95	1.00	1.00	1.00	1.00	1.00	1.00	1.00
Ped Bike Factor								1.00				0.98
Fr <sub>t</sub>			0.850			0.850			0.850			0.850
Fl <sub>t</sub> Protected	0.950			0.950				0.958			0.966	
Satd. Flow (prot)	1805	3471	1553	1752	3438	1615	0	1759	1509	0	1835	1615
Fl <sub>t</sub> Permitted	0.321			0.114				0.621			0.581	
Satd. Flow (perm)	610	3471	1553	210	3438	1615	0	1137	1509	0	1104	1590
Right Turn on Red			Yes			Yes			Yes			Yes
Satd. Flow (RTOR)			164			52			309			100
Link Speed (k/h)		60			60			50			50	
Link Distance (m)		455.2			323.0			477.1			562.7	
Travel Time (s)		27.3			19.4			34.4			40.5	
Confl. Peds. (#/hr)							3					3
Peak Hour Factor	0.82	0.82	0.82	0.87	0.87	0.87	0.70	0.70	0.70	0.93	0.93	0.93
Heavy Vehicles (%)	0%	4%	4%	3%	5%	0%	4%	0%	7%	0%	0%	0%
Adj. Flow (vph)	76	1017	179	155	885	11	324	46	309	75	31	125
Shared Lane Traffic (%)												
Lane Group Flow (vph)	76	1017	179	155	885	11	0	370	309	0	106	125
Enter Blocked Intersection	No	No	No	No	No	No	No	No	No	No	No	No
Lane Alignment	Left	Left	Right	Left	Left	Right	Left	Left	Right	Left	Left	Right
Median Width(m)		3.6			3.6			0.0			0.0	
Link Offset(m)		0.0			0.0			0.0			0.0	
Crosswalk Width(m)		4.8			4.8			4.8			4.8	
Two way Left Turn Lane												
Headway Factor	1.00	1.00	1.00	1.00	1.00	1.00	1.00	1.00	1.00	1.00	1.00	1.00
Turning Speed (k/h)	25		15	25		15	25		15	25		15
Number of Detectors	1	2	1	1	2	1	1	1	1	1	1	1
Detector Template	Left		Right	Left		Right	Left			Left		
Leading Detector (m)	2.0	98.8	2.0	2.0	91.8	2.0	2.0	9.0	9.0	2.0	9.0	9.0
Trailing Detector (m)	0.0	-3.0	0.0	0.0	-3.0	0.0	0.0	-3.0	-3.0	0.0	-0.2	-3.0
Detector 1 Position(m)	0.0	-3.0	0.0	0.0	-3.0	0.0	0.0	-3.0	-3.0	0.0	-0.2	-3.0
Detector 1 Size(m)	2.0	12.0	2.0	2.0	12.0	2.0	2.0	12.0	12.0	2.0	9.2	12.0
Detector 1 Type	Cl+Ex	Cl+Ex	Cl+Ex	Cl+Ex	Cl+Ex	Cl+Ex	Cl+Ex	Cl+Ex	Cl+Ex	Cl+Ex	Cl+Ex	Cl+Ex
Detector 1 Channel												
Detector 1 Extend (s)	0.0	0.0	0.0	0.0	0.0	0.0	0.0	0.0	0.0	0.0	0.0	0.0
Detector 1 Queue (s)	0.0	0.0	0.0	0.0	0.0	0.0	0.0	0.0	0.0	0.0	0.0	0.0
Detector 1 Delay (s)	0.0	0.0	0.0	0.0	0.0	0.0	0.0	0.0	0.0	0.0	0.0	0.0
Detector 2 Position(m)		97.0			90.0							
Detector 2 Size(m)		1.8			1.8							
Detector 2 Type		Cl+Ex			Cl+Ex							
Detector 2 Channel												
Detector 2 Extend (s)		0.0			0.0							

Perthmore Subdivision TIS  
 12: Wilson Street /Canadian tire Ent/Ext & HWY 7

2035 Total Conditions  
 PM Peak Hour



Lane Group	EBL	EBT	EBR	WBL	WBT	WBR	NBL	NBT	NBR	SBL	SBT	SBR
Turn Type	Perm	NA	Perm	pm+pt	NA	Perm	pm+pt	NA	Perm	Perm	NA	Perm
Protected Phases		2		1	6		3	8			4	
Permitted Phases	2		2	6		6	8		8	4		4
Detector Phase	2	2	2	1	1 6	6	3	3 8	8	4	4	4
Switch Phase												
Minimum Initial (s)	20.0	20.0	20.0	7.0	20.0	20.0	7.0	10.0	10.0	10.0	10.0	10.0
Minimum Split (s)	43.9	43.9	43.9	9.0	43.9	43.9	9.0	37.4	37.4	37.4	37.4	37.4
Total Split (s)	43.9	43.9	43.9	16.0	59.9	59.9	16.0	53.4	53.4	37.4	37.4	37.4
Total Split (%)	38.7%	38.7%	38.7%	14.1%	52.9%	52.9%	14.1%	47.1%	47.1%	33.0%	33.0%	33.0%
Maximum Green (s)	37.0	37.0	37.0	14.0	53.0	53.0	14.0	47.0	47.0	31.0	31.0	31.0
Yellow Time (s)	5.0	5.0	5.0	2.0	5.0	5.0	2.0	4.1	4.1	4.1	4.1	4.1
All-Red Time (s)	1.9	1.9	1.9	0.0	1.9	1.9	0.0	2.3	2.3	2.3	2.3	2.3
Lost Time Adjust (s)	0.0	0.0	0.0	0.0	0.0	0.0		0.0	0.0		0.0	0.0
Total Lost Time (s)	6.9	6.9	6.9	2.0	6.9	6.9		6.4	6.4		6.4	6.4
Lead/Lag	Lag	Lag	Lag	Lead			Lead			Lag	Lag	Lag
Lead-Lag Optimize?	Yes	Yes	Yes	Yes			Yes			Yes	Yes	Yes
Vehicle Extension (s)	4.5	4.5	4.5	2.0	4.5	4.5	2.0	3.0	3.0	3.0	3.0	3.0
Recall Mode	Min	Min	Min	None	Min	Min	None	None	None	None	None	None
Walk Time (s)	7.0	7.0	7.0		7.0	7.0		7.0	7.0	7.0	7.0	7.0
Flash Dont Walk (s)	30.0	30.0	30.0		30.0	30.0		24.0	24.0	24.0	24.0	24.0
Pedestrian Calls (#/hr)	0	0	0		0	0		3	3	0	0	0
Act Effct Green (s)	37.2	37.2	37.2	58.3	53.4	53.4		37.4	37.4		21.2	21.2
Actuated g/C Ratio	0.36	0.36	0.36	0.56	0.51	0.51		0.36	0.36		0.20	0.20
v/c Ratio	0.35	0.82	0.27	0.48	0.50	0.01		0.80	0.42		0.47	0.31
Control Delay	33.2	38.3	6.6	19.4	19.1	0.0		41.5	4.2		42.6	11.9
Queue Delay	0.0	0.0	0.0	0.0	0.0	0.0		0.0	0.0		0.0	0.0
Total Delay	33.2	38.3	6.6	19.4	19.1	0.0		41.5	4.2		42.6	11.9
LOS	C	D	A	B	B	A		D	A		D	B
Approach Delay		33.5			19.0			24.5			26.0	
Approach LOS		C			B			C			C	
Queue Length 50th (m)	12.0	104.2	2.1	15.5	64.0	0.0		62.8	0.0		19.9	4.3
Queue Length 95th (m)	25.6	128.4	13.9	32.7	90.7	0.0		65.9	2.9		36.7	19.3
Internal Link Dist (m)		431.2			299.0			453.1			538.7	
Turn Bay Length (m)	50.0		75.0	45.0		30.0						7.5
Base Capacity (vph)	218	1242	660	326	1762	853		574	854		331	546
Starvation Cap Reductn	0	0	0	0	0	0		0	0		0	0
Spillback Cap Reductn	0	0	0	0	0	0		0	0		0	0
Storage Cap Reductn	0	0	0	0	0	0		0	0		0	0
Reduced v/c Ratio	0.35	0.82	0.27	0.48	0.50	0.01		0.64	0.36		0.32	0.23

**Intersection Summary**

Area Type: Other

Cycle Length: 113.3

Actuated Cycle Length: 104.1

Natural Cycle: 100

Control Type: Semi Act-Uncoord

Maximum v/c Ratio: 0.82

Intersection Signal Delay: 26.4

Intersection Capacity Utilization 75.7%

Intersection LOS: C

ICU Level of Service D

Analysis Period (min) 15

Splits and Phases: 12: Wilson Street /Canadian tire Ent/Ext & HWY 7

↙ Ø1	→ Ø2	↖ Ø3	↓ Ø4
16 s	43.9 s	16 s	37.4 s
↙ Ø6		↖ Ø8	
59.9 s		53.4 s	

Perthmore Subdivision TIS  
 15: Drummond Street/Dufferin Street & HWY 7

2035 Total Conditions  
 PM Peak Hour



Lane Group	EBL	EBT	EBR	WBL	WBT	WBR	NBL	NBT	NBR	SBL	SBT	SBR
Lane Configurations												
Traffic Volume (vph)	78	610	394	160	560	6	293	23	141	16	28	78
Future Volume (vph)	78	610	394	160	560	6	293	23	141	16	28	78
Ideal Flow (vphpl)	1900	1900	1900	1900	1900	1900	1900	1900	1900	1900	1900	1900
Storage Length (m)	30.0		45.0	30.0		15.0	65.0		0.0	40.0		0.0
Storage Lanes	1		1	1		0	1		0	1		0
Taper Length (m)	7.5			7.5			0.0			20.0		
Lane Util. Factor	1.00	0.95	1.00	0.91	0.91	0.95	1.00	1.00	1.00	1.00	1.00	1.00
Ped Bike Factor							1.00	0.99		1.00	0.99	
Frt			0.850		0.999			0.871				0.889
Flt Protected	0.950			0.950	0.999		0.950			0.950		
Satd. Flow (prot)	1770	3374	1615	1643	3293	0	1787	1606	0	1805	1648	0
Flt Permitted	0.406			0.239	0.935		0.453			0.640		
Satd. Flow (perm)	756	3374	1615	413	3082	0	851	1606	0	1213	1648	0
Right Turn on Red			Yes			Yes			Yes			Yes
Satd. Flow (RTOR)			446		1			160			101	
Link Speed (k/h)		60			60			50			50	
Link Distance (m)		323.0			143.7			376.3			222.4	
Travel Time (s)		19.4			8.6			27.1			16.0	
Confl. Peds. (#/hr)							2		3	3		2
Peak Hour Factor	0.81	0.81	0.81	0.94	0.94	0.94	0.88	0.88	0.88	0.77	0.77	0.77
Heavy Vehicles (%)	2%	7%	0%	0%	5%	0%	1%	0%	2%	0%	0%	2%
Adj. Flow (vph)	96	753	486	170	596	6	333	26	160	21	36	101
Shared Lane Traffic (%)				10%								
Lane Group Flow (vph)	96	753	486	153	619	0	333	186	0	21	137	0
Enter Blocked Intersection	No	No	No	No	No	No	No	No	No	No	No	No
Lane Alignment	Left	Left	Right	Left	Left	Right	Left	Left	Right	Left	Left	Right
Median Width(m)		3.6			3.6			3.6			3.6	
Link Offset(m)		0.0			0.0			0.0			0.0	
Crosswalk Width(m)		4.8			4.8			4.8			4.8	
Two way Left Turn Lane												
Headway Factor	1.00	1.00	1.00	1.00	1.00	1.00	1.00	1.00	1.00	1.00	1.00	1.00
Turning Speed (k/h)	25		15	25		15	25		15	25		15
Number of Detectors	1	1	1	1	2		1	1		1	1	
Detector Template	Left		Right	Left								
Leading Detector (m)	2.0	94.8	2.0	2.0	86.8		9.0	9.0		9.0	9.0	
Trailing Detector (m)	0.0	93.0	0.0	0.0	-1.0		-3.0	-3.0		-3.0	-3.0	
Detector 1 Position(m)	0.0	93.0	0.0	0.0	-1.0		-3.0	-3.0		-3.0	-3.0	
Detector 1 Size(m)	2.0	1.8	2.0	2.0	12.0		12.0	12.0		12.0	12.0	
Detector 1 Type	Cl+Ex	Cl+Ex	Cl+Ex	Cl+Ex	Cl+Ex		Cl+Ex	Cl+Ex		Cl+Ex	Cl+Ex	
Detector 1 Channel												
Detector 1 Extend (s)	0.0	0.0	0.0	0.0	0.0		0.0	0.0		0.0	0.0	
Detector 1 Queue (s)	0.0	0.0	0.0	0.0	0.0		0.0	0.0		0.0	0.0	
Detector 1 Delay (s)	0.0	0.0	0.0	0.0	0.0		0.0	0.0		0.0	0.0	
Detector 2 Position(m)					85.0							
Detector 2 Size(m)					1.8							
Detector 2 Type					Cl+Ex							
Detector 2 Channel												
Detector 2 Extend (s)					0.0							



Perthmore Subdivision TIS  
 15: Drummond Street/Dufferin Street & HWY 7

2035 Total Conditions  
 PM Peak Hour



Lane Group	EBL	EBT	EBR	WBL	WBT	WBR	NBL	NBT	NBR	SBL	SBT	SBR
Turn Type	Perm	NA	Perm	pm+pt	NA		pm+pt	NA		Perm	NA	
Protected Phases		2		1	6		3	8				4
Permitted Phases	2		2	6			8			4		
Detector Phase	2	2	2	1	6		3	8		4		4
Switch Phase												
Minimum Initial (s)	20.0	20.0	20.0	7.0	20.0		5.0	10.0		10.0		10.0
Minimum Split (s)	33.3	33.3	33.3	10.0	36.3		9.5	38.3		38.3		38.3
Total Split (s)	35.7	35.7	35.7	10.0	45.7		11.0	49.3		38.3		38.3
Total Split (%)	37.6%	37.6%	37.6%	10.5%	48.1%		11.6%	51.9%		40.3%		40.3%
Maximum Green (s)	29.4	29.4	29.4	7.0	39.4		6.5	43.0		32.0		32.0
Yellow Time (s)	5.0	5.0	5.0	3.0	5.0		3.5	4.1		4.1		4.1
All-Red Time (s)	1.3	1.3	1.3	0.0	1.3		1.0	2.2		2.2		2.2
Lost Time Adjust (s)	0.0	0.0	0.0	0.0	0.0		0.0	0.0		0.0		0.0
Total Lost Time (s)	6.3	6.3	6.3	3.0	6.3		4.5	6.3		6.3		6.3
Lead/Lag	Lag	Lag	Lag	Lead			Lead			Lag		Lag
Lead-Lag Optimize?	Yes	Yes	Yes	Yes			Yes			Yes		Yes
Vehicle Extension (s)	4.6	4.6	4.6	3.0	4.6		3.0	3.0		3.0		3.0
Recall Mode	Min	Min	Min	None	Min		None	None		None		None
Walk Time (s)	7.0	7.0	7.0		7.0			7.0		7.0		7.0
Flash Dont Walk (s)	20.0	20.0	20.0		20.0			25.0		25.0		25.0
Pedestrian Calls (#/hr)	0	0	0		0			2		0		0
Act Effct Green (s)	23.8	23.8	23.8	37.4	34.0		22.3	20.4		12.0		12.0
Actuated g/C Ratio	0.35	0.35	0.35	0.56	0.51		0.33	0.30		0.18		0.18
v/c Ratio	0.36	0.63	0.57	0.42	0.39		0.85	0.31		0.10		0.36
Control Delay	22.7	21.8	5.8	12.7	12.1		42.5	6.2		26.1		12.6
Queue Delay	0.0	0.0	0.0	0.0	0.0		0.0	0.0		0.0		0.0
Total Delay	22.7	21.8	5.8	12.7	12.1		42.5	6.2		26.1		12.6
LOS	C	C	A	B	B		D	A		C		B
Approach Delay		16.1			12.2			29.5				14.4
Approach LOS		B			B			C				B
Queue Length 50th (m)	9.2	42.6	3.4	10.0	25.7		34.1	2.3		2.4		4.1
Queue Length 95th (m)	22.6	64.5	16.6	26.3	49.6		#73.3	14.8		7.2		13.8
Internal Link Dist (m)		299.0			119.7			352.3				198.4
Turn Bay Length (m)	30.0		45.0	30.0			65.0			40.0		
Base Capacity (vph)	337	1507	968	360	1857		392	1104		589		853
Starvation Cap Reductn	0	0	0	0	0		0	0		0		0
Spillback Cap Reductn	0	0	0	0	0		0	0		0		0
Storage Cap Reductn	0	0	0	0	0		0	0		0		0
Reduced v/c Ratio	0.28	0.50	0.50	0.42	0.33		0.85	0.17		0.04		0.16

Intersection Summary

Area Type:	Other
Cycle Length:	95
Actuated Cycle Length:	67.3
Natural Cycle:	95
Control Type:	Semi Act-Uncoord
Maximum v/c Ratio:	0.85
Intersection Signal Delay:	17.4
Intersection Capacity Utilization	72.5%
Intersection LOS:	B
ICU Level of Service	C

Analysis Period (min) 15

# 95th percentile volume exceeds capacity, queue may be longer.

Queue shown is maximum after two cycles.

Splits and Phases: 15: Drummond Street/Dufferin Street & HWY 7

↙ Ø1	→ Ø2	↖ Ø3	↓ Ø4
10 s	35.7 s	11 s	38.3 s
← Ø6		↗ Ø8	
45.7 s		49.3 s	

Perthmore Subdivision TIS  
26: Wilson Street & Sunset Boulevard

2035 Total Conditions  
PM Peak Hour



Lane Group	EBL	EBT	EBR	WBL	WBT	WBR	NBL	NBT	NBR	SBL	SBT	SBR
Lane Configurations		↕	↗		↕		↖	↕		↖	↕	↗
Traffic Volume (vph)	164	36	277	12	59	36	126	775	6	17	806	78
Future Volume (vph)	164	36	277	12	59	36	126	775	6	17	806	78
Ideal Flow (vphpl)	1900	1900	1900	1900	1900	1900	1900	1900	1900	1900	1900	1900
Storage Length (m)	0.0		0.0	0.0		0.0	15.0		0.0	25.0		0.0
Storage Lanes	0		1	0		0	1		0	1		1
Taper Length (m)	7.5			7.5			7.5			7.5		
Lane Util. Factor	1.00	1.00	1.00	1.00	1.00	1.00	1.00	1.00	1.00	1.00	1.00	1.00
Ped Bike Factor		0.98	0.94		0.98			1.00				0.91
Frt			0.850		0.955			0.999				0.850
Flt Protected		0.961			0.994		0.950			0.950		
Satd. Flow (prot)	0	1728	1583	0	1762	0	1770	1842	0	1805	1863	1615
Flt Permitted		0.711			0.952		0.137			0.153		
Satd. Flow (perm)	0	1258	1492	0	1682	0	255	1842	0	291	1863	1464
Right Turn on Red			Yes			Yes			Yes			Yes
Satd. Flow (RTOR)			215		43			1				113
Link Speed (k/h)		50			50			50				50
Link Distance (m)		238.8			244.8			341.7				185.6
Travel Time (s)		17.2			17.6			24.6				13.4
Confl. Peds. (#/hr)	26		23	23		26	45		20	20		45
Peak Hour Factor	0.93	0.93	0.93	0.77	0.77	0.77	0.87	0.87	0.87	0.83	0.83	0.83
Heavy Vehicles (%)	6%	4%	2%	0%	2%	0%	2%	3%	0%	0%	2%	0%
Adj. Flow (vph)	176	39	298	16	77	47	145	891	7	20	971	94
Shared Lane Traffic (%)												
Lane Group Flow (vph)	0	215	298	0	140	0	145	898	0	20	971	94
Enter Blocked Intersection	No	No	No	No	No	No	No	No	No	No	No	No
Lane Alignment	Left	Left	Right	Left	Left	Right	Left	Left	Right	Left	Left	Right
Median Width(m)		0.0			0.0			3.6			3.6	
Link Offset(m)		0.0			0.0			0.0			0.0	
Crosswalk Width(m)		4.8			4.8			4.8			4.8	
Two way Left Turn Lane												
Headway Factor	1.00	1.00	1.00	1.00	1.00	1.00	1.00	1.00	1.00	1.00	1.00	1.00
Turning Speed (k/h)	25		15	25		15	25		15	25		15
Number of Detectors	1	2	1	1	2		1	2		1	2	1
Detector Template	Left		Right	Left	Thru			Thru			Thru	Right
Leading Detector (m)	2.0	10.0	2.0	2.0	10.0		3.0	10.0		3.0	10.0	2.0
Trailing Detector (m)	0.0	5.0	0.0	0.0	0.0		-1.0	0.0		-1.0	0.0	0.0
Detector 1 Position(m)	0.0	5.0	0.0	0.0	0.0		-1.0	0.0		-1.0	0.0	0.0
Detector 1 Size(m)	2.0	5.0	2.0	2.0	0.6		4.0	0.6		4.0	0.6	2.0
Detector 1 Type	Cl+Ex	Cl+Ex	Cl+Ex	Cl+Ex	Cl+Ex		Cl+Ex	Cl+Ex		Cl+Ex	Cl+Ex	Cl+Ex
Detector 1 Channel												
Detector 1 Extend (s)	0.0	0.0	0.0	0.0	0.0		0.0	0.0		0.0	0.0	0.0
Detector 1 Queue (s)	0.0	0.0	0.0	0.0	0.0		0.0	0.0		0.0	0.0	0.0
Detector 1 Delay (s)	0.0	0.0	0.0	0.0	0.0		0.0	0.0		0.0	0.0	0.0
Detector 2 Position(m)		9.4			9.4			9.4			9.4	
Detector 2 Size(m)		0.6			0.6			0.6			0.6	
Detector 2 Type		Cl+Ex			Cl+Ex			Cl+Ex			Cl+Ex	
Detector 2 Channel												
Detector 2 Extend (s)		0.0			0.0			0.0			0.0	

Perthmore Subdivision TIS  
26: Wilson Street & Sunset Boulevard

2035 Total Conditions  
PM Peak Hour



Lane Group	EBL	EBT	EBR	WBL	WBT	WBR	NBL	NBT	NBR	SBL	SBT	SBR
Turn Type	Perm	NA	Perm	Perm	NA		pm+pt	NA		pm+pt	NA	Perm
Protected Phases		4			8		5	2		1	6	
Permitted Phases	4		4	8			2			6		6
Detector Phase	4	4	4	8	8		5	2		1	6	6
Switch Phase							2			6		
Minimum Initial (s)	10.0	10.0	10.0	10.0	10.0		5.0	10.0		5.0	10.0	10.0
Minimum Split (s)	22.6	22.6	22.6	22.6	22.6		9.6	22.6		9.6	22.6	22.6
Total Split (s)	22.6	22.6	22.6	22.6	22.6		9.6	27.8		9.6	27.8	27.8
Total Split (%)	37.7%	37.7%	37.7%	37.7%	37.7%		16.0%	46.3%		16.0%	46.3%	46.3%
Maximum Green (s)	18.0	18.0	18.0	18.0	18.0		5.0	23.2		5.0	23.2	23.2
Yellow Time (s)	3.3	3.3	3.3	3.3	3.3		3.3	3.3		3.3	3.3	3.3
All-Red Time (s)	1.3	1.3	1.3	1.3	1.3		1.3	1.3		1.3	1.3	1.3
Lost Time Adjust (s)		0.0	0.0		0.0		0.0	0.0		0.0	0.0	0.0
Total Lost Time (s)		4.6	4.6		4.6		4.6	4.6		4.6	4.6	4.6
Lead/Lag							Lead	Lag		Lead	Lag	Lag
Lead-Lag Optimize?							Yes	Yes		Yes	Yes	Yes
Vehicle Extension (s)	3.0	3.0	3.0	3.0	3.0		3.0	3.0		3.0	3.0	3.0
Recall Mode	None	None	None	None	None		None	Min		None	Min	Min
Walk Time (s)	7.0	7.0	7.0	7.0	7.0			7.0			7.0	7.0
Flash Dont Walk (s)	11.0	11.0	11.0	11.0	11.0			11.0			11.0	11.0
Pedestrian Calls (#/hr)	16	16	16	35	35			20			20	20
Act Effct Green (s)		14.2	14.2		14.2		30.0	29.1		27.4	23.6	23.6
Actuated g/C Ratio		0.26	0.26		0.26		0.55	0.53		0.50	0.43	0.43
v/c Ratio		0.66	0.54		0.30		0.51	0.91		0.07	1.20	0.13
Control Delay		29.1	9.9		14.0		15.6	30.5		6.8	124.9	2.9
Queue Delay		0.0	0.0		0.0		0.0	0.0		0.0	0.0	0.0
Total Delay		29.1	9.9		14.0		15.6	30.5		6.8	124.9	2.9
LOS		C	A		B		B	C		A	F	A
Approach Delay		17.9			14.0			28.4			112.2	
Approach LOS		B			B			C			F	
Queue Length 50th (m)		20.8	7.0		8.3		6.1	68.3		0.8	~136.6	0.0
Queue Length 95th (m)		40.7	25.0		16.2		#20.8	#192.2		3.1	#193.0	4.9
Internal Link Dist (m)		214.8			220.8			317.7			161.6	
Turn Bay Length (m)							15.0			25.0		
Base Capacity (vph)		423	644		594		282	986		287	807	698
Starvation Cap Reductn		0	0		0		0	0		0	0	0
Spillback Cap Reductn		0	0		0		0	0		0	0	0
Storage Cap Reductn		0	0		0		0	0		0	0	0
Reduced v/c Ratio		0.51	0.46		0.24		0.51	0.91		0.07	1.20	0.13

Intersection Summary

Area Type:	Other
Cycle Length:	60
Actuated Cycle Length:	54.4
Natural Cycle:	90
Control Type:	Semi Act-Uncoord
Maximum v/c Ratio:	1.20
Intersection Signal Delay:	58.4
Intersection Capacity Utilization	85.4%
Intersection LOS:	E
ICU Level of Service	E

Analysis Period (min) 15

~ Volume exceeds capacity, queue is theoretically infinite.

Queue shown is maximum after two cycles.

# 95th percentile volume exceeds capacity, queue may be longer.

Queue shown is maximum after two cycles.

Splits and Phases: 26: Wilson Street & Sunset Boulevard

↙ Ø1	↑ Ø2	↘ Ø4
9.6 s	27.8 s	22.6 s
↙ Ø5	↓ Ø6	← Ø8
9.6 s	27.8 s	22.6 s

Perthmore Subdivision TIS  
 30: Wilson Street & Leslie Street/Isabella Street

2035 Total Conditions  
 PM Peak Hour



Lane Group	EBL	EBT	EBR	WBL	WBT	WBR	NBL	NBT	NBR	SBL	SBT	SBR
Lane Configurations		↕			↕		↗	↘		↗	↘	
Traffic Volume (vph)	146	30	7	38	35	92	3	724	4	49	838	58
Future Volume (vph)	146	30	7	38	35	92	3	724	4	49	838	58
Ideal Flow (vphpl)	1900	1900	1900	1900	1900	1900	1900	1900	1900	1900	1900	1900
Storage Length (m)	0.0		0.0	0.0		0.0	60.0		0.0	25.0		0.0
Storage Lanes	0		0	0		0	1		0	1		0
Taper Length (m)	7.5			7.5			25.0			15.0		
Lane Util. Factor	1.00	1.00	1.00	1.00	1.00	1.00	1.00	1.00	1.00	1.00	1.00	1.00
Ped Bike Factor		0.99			0.98			1.00		1.00	0.99	
Frt		0.995			0.925			0.999			0.990	
Flt Protected		0.962			0.989		0.950			0.950		
Satd. Flow (prot)	0	1772	0	0	1707	0	1805	1843	0	1703	1819	0
Flt Permitted		0.595			0.920		0.118			0.199		
Satd. Flow (perm)	0	1090	0	0	1581	0	224	1843	0	356	1819	0
Right Turn on Red			Yes			Yes			Yes			Yes
Satd. Flow (RTOR)		3			91			1			9	
Link Speed (k/h)		50			50			50			50	
Link Distance (m)		224.9			415.9			340.1			341.7	
Travel Time (s)		16.2			29.9			24.5			24.6	
Confl. Peds. (#/hr)	4		14	14		4	41		10	10		41
Peak Hour Factor	0.76	0.76	0.76	0.90	0.90	0.90	0.96	0.96	0.96	0.85	0.85	0.85
Heavy Vehicles (%)	3%	0%	0%	0%	0%	0%	0%	3%	0%	6%	3%	0%
Adj. Flow (vph)	192	39	9	42	39	102	3	754	4	58	986	68
Shared Lane Traffic (%)												
Lane Group Flow (vph)	0	240	0	0	183	0	3	758	0	58	1054	0
Enter Blocked Intersection	No	No	No	No	No	No	No	No	No	No	No	No
Lane Alignment	Left	Left	Right	Left	Left	Right	Left	Left	Right	Left	Left	Right
Median Width(m)		0.0			0.0			3.6			3.6	
Link Offset(m)		0.0			0.0			0.0			0.0	
Crosswalk Width(m)		4.8			4.8			4.8			4.8	
Two way Left Turn Lane												
Headway Factor	1.00	1.00	1.00	1.00	1.00	1.00	1.00	1.00	1.00	1.00	1.00	1.00
Turning Speed (k/h)	25		15	25		15	25		15	25		15
Number of Detectors	1	2		1	2		1	2		1	2	
Detector Template	Left	Thru		Left	Thru		Left	Thru		Left	Thru	
Leading Detector (m)	2.0	10.0		2.0	10.0		2.0	10.0		2.0	10.0	
Trailing Detector (m)	0.0	0.0		0.0	0.0		0.0	0.0		0.0	0.0	
Detector 1 Position(m)	0.0	0.0		0.0	0.0		0.0	0.0		0.0	0.0	
Detector 1 Size(m)	2.0	0.6		2.0	0.6		2.0	0.6		2.0	0.6	
Detector 1 Type	Cl+Ex	Cl+Ex		Cl+Ex	Cl+Ex		Cl+Ex	Cl+Ex		Cl+Ex	Cl+Ex	
Detector 1 Channel												
Detector 1 Extend (s)	0.0	0.0		0.0	0.0		0.0	0.0		0.0	0.0	
Detector 1 Queue (s)	0.0	0.0		0.0	0.0		0.0	0.0		0.0	0.0	
Detector 1 Delay (s)	0.0	0.0		0.0	0.0		0.0	0.0		0.0	0.0	
Detector 2 Position(m)		9.4			9.4			9.4			9.4	
Detector 2 Size(m)		0.6			0.6			0.6			0.6	
Detector 2 Type		Cl+Ex			Cl+Ex			Cl+Ex			Cl+Ex	
Detector 2 Channel												
Detector 2 Extend (s)		0.0			0.0			0.0			0.0	

Perthmore Subdivision TIS  
 30: Wilson Street & Leslie Street/Isabella Street

2035 Total Conditions  
 PM Peak Hour



Lane Group	EBL	EBT	EBR	WBL	WBT	WBR	NBL	NBT	NBR	SBL	SBT	SBR
Turn Type	Perm	NA		Perm	NA		pm+pt	NA		pm+pt	NA	
Protected Phases		4			8		5	2		1	6	
Permitted Phases	4			8			2			6		
Detector Phase	4	4		8	8		5	2		1	6	
Switch Phase							2			6		
Minimum Initial (s)	10.0	10.0		10.0	10.0		5.0	10.0		5.0	10.0	
Minimum Split (s)	15.0	15.0		15.0	15.0		9.6	35.0		9.6	35.0	
Total Split (s)	15.0	15.0		15.0	15.0		9.6	35.4		9.6	35.4	
Total Split (%)	25.0%	25.0%		25.0%	25.0%		16.0%	59.0%		16.0%	59.0%	
Maximum Green (s)	10.4	10.4		10.4	10.4		5.0	30.8		5.0	30.8	
Yellow Time (s)	3.3	3.3		3.3	3.3		3.3	3.3		3.3	3.3	
All-Red Time (s)	1.3	1.3		1.3	1.3		1.3	1.3		1.3	1.3	
Lost Time Adjust (s)		0.0			0.0		0.0	0.0		0.0	0.0	
Total Lost Time (s)		4.6			4.6		4.6	4.6		4.6	4.6	
Lead/Lag							Lead	Lag		Lead	Lag	
Lead-Lag Optimize?							Yes	Yes		Yes	Yes	
Vehicle Extension (s)	3.0	3.0		3.0	3.0		3.0	3.0		3.0	3.0	
Recall Mode	None	None		None	None		None	Max		None	Max	
Walk Time (s)	5.0	5.0		5.0	5.0			7.0			7.0	
Flash Dont Walk (s)	5.0	5.0		5.0	5.0			11.0			11.0	
Pedestrian Calls (#/hr)	10	10		4	4			14			33	
Act Effect Green (s)		10.5			10.5		35.1	32.2		36.8	35.9	
Actuated g/C Ratio		0.18			0.18		0.61	0.56		0.64	0.63	
v/c Ratio		1.19			0.51		0.01	0.73		0.17	0.92	
Control Delay		155.1			17.5		3.3	16.7		4.6	27.0	
Queue Delay		0.0			0.0		0.0	0.0		0.0	0.0	
Total Delay		155.1			17.5		3.3	16.7		4.6	27.0	
LOS		F			B		A	B		A	C	
Approach Delay		155.1			17.5			16.6			25.8	
Approach LOS		F			B			B			C	
Queue Length 50th (m)		~36.1			9.5		0.1	66.4		1.8	74.9	
Queue Length 95th (m)		#59.8			26.4		0.7	#131.1		4.3	#196.2	
Internal Link Dist (m)		200.9			391.9			316.1			317.7	
Turn Bay Length (m)							60.0			25.0		
Base Capacity (vph)		201			362		275	1034		346	1140	
Starvation Cap Reductn		0			0		0	0		0	0	
Spillback Cap Reductn		0			0		0	0		0	0	
Storage Cap Reductn		0			0		0	0		0	0	
Reduced v/c Ratio		1.19			0.51		0.01	0.73		0.17	0.92	

Intersection Summary

Area Type:	Other
Cycle Length:	60
Actuated Cycle Length:	57.4
Natural Cycle:	100
Control Type:	Semi Act-Uncoord
Maximum v/c Ratio:	1.19
Intersection Signal Delay:	35.6
Intersection Capacity Utilization	79.3%
Intersection LOS:	D
ICU Level of Service	D

Analysis Period (min) 15

~ Volume exceeds capacity, queue is theoretically infinite.

Queue shown is maximum after two cycles.

# 95th percentile volume exceeds capacity, queue may be longer.

Queue shown is maximum after two cycles.

Splits and Phases: 30: Wilson Street & Leslie Street/Isabella Street





Perthmore Subdivision TIS  
 3: Drummond Concession 2 & Perthmore

2035 Total Conditions  
 PM Peak Hour

Intersection						
Int Delay, s/veh	2.2					
Movement	EBL	EBT	WBT	WBR	SBL	SBR
Lane Configurations		↕	↑	↗	↘	
Traffic Vol, veh/h	63	269	197	32	11	54
Future Vol, veh/h	63	269	197	32	11	54
Conflicting Peds, #/hr	0	0	0	0	0	0
Sign Control	Free	Free	Free	Free	Stop	Stop
RT Channelized	-	None	-	None	-	None
Storage Length	-	-	-	25	0	-
Veh in Median Storage, #	-	0	0	-	0	-
Grade, %	-	0	0	-	0	-
Peak Hour Factor	85	85	83	83	68	68
Heavy Vehicles, %	20	2	0	0	25	0
Mvmt Flow	74	316	237	39	16	79

Major/Minor	Major1	Major2	Minor2		
Conflicting Flow All	276	0	0	701	237
Stage 1	-	-	-	237	-
Stage 2	-	-	-	464	-
Critical Hdwy	4.3	-	-	6.65	6.2
Critical Hdwy Stg 1	-	-	-	5.65	-
Critical Hdwy Stg 2	-	-	-	5.65	-
Follow-up Hdwy	2.38	-	-	3.725	3.3
Pot Cap-1 Maneuver	1190	-	-	372	807
Stage 1	-	-	-	751	-
Stage 2	-	-	-	587	-
Platoon blocked, %	-	-	-	-	-
Mov Cap-1 Maneuver	1190	-	-	344	807
Mov Cap-2 Maneuver	-	-	-	344	-
Stage 1	-	-	-	695	-
Stage 2	-	-	-	587	-

Approach	EB	WB	SB
HCM Control Delay, s	1.6	0	11.4
HCM LOS			B

Minor Lane/Major Mvmt	EBL	EBT	WBT	WBR	SBLn1
Capacity (veh/h)	1190	-	-	-	657
HCM Lane V/C Ratio	0.062	-	-	-	0.145
HCM Control Delay (s)	8.2	0	-	-	11.4
HCM Lane LOS	A	A	-	-	B
HCM 95th %tile Q(veh)	0.2	-	-	-	0.5

Intersection						
Int Delay, s/veh	1.9					
Movement	EBT	EBR	WBL	WBT	NBL	NBR
Lane Configurations						
Traffic Vol, veh/h	89	14	24	103	12	20
Future Vol, veh/h	89	14	24	103	12	20
Conflicting Peds, #/hr	0	0	0	0	1	10
Sign Control	Free	Free	Free	Free	Stop	Stop
RT Channelized	-	None	-	None	-	None
Storage Length	-	-	-	-	0	-
Veh in Median Storage, #	0	-	-	0	0	-
Grade, %	0	-	-	0	0	-
Peak Hour Factor	78	78	72	72	75	75
Heavy Vehicles, %	2	0	0	1	0	10
Mvmt Flow	114	18	33	143	16	27

Major/Minor	Major1	Major2	Minor1		
Conflicting Flow All	0	0	132	0	333
Stage 1	-	-	-	-	123
Stage 2	-	-	-	-	210
Critical Hdwy	-	-	4.1	-	6.4
Critical Hdwy Stg 1	-	-	-	-	5.4
Critical Hdwy Stg 2	-	-	-	-	5.4
Follow-up Hdwy	-	-	2.2	-	3.5
Pot Cap-1 Maneuver	-	-	1466	-	666
Stage 1	-	-	-	-	907
Stage 2	-	-	-	-	830
Platoon blocked, %	-	-	-	-	-
Mov Cap-1 Maneuver	-	-	1466	-	649
Mov Cap-2 Maneuver	-	-	-	-	649
Stage 1	-	-	-	-	907
Stage 2	-	-	-	-	809

Approach	EB	WB	NB
HCM Control Delay, s	0	1.4	9.9
HCM LOS			A

Minor Lane/Major Mvmt	NBLn1	EBT	EBR	WBL	WBT
Capacity (veh/h)	780	-	-	1466	-
HCM Lane V/C Ratio	0.055	-	-	0.023	-
HCM Control Delay (s)	9.9	-	-	7.5	0
HCM Lane LOS	A	-	-	A	A
HCM 95th %tile Q(veh)	0.2	-	-	0.1	-

Perthmore Subdivision TIS  
34: Wilson Street & North Street

2035 Total Conditions  
PM Peak Hour

Intersection												
Int Delay, s/veh	16.2											
Movement	EBL	EBT	EBR	WBL	WBT	WBR	NBL	NBT	NBR	SBL	SBT	SBR
Lane Configurations		↕			↕			↕			↕	
Traffic Vol, veh/h	7	6	14	16	12	151	13	559	35	172	658	33
Future Vol, veh/h	7	6	14	16	12	151	13	559	35	172	658	33
Conflicting Peds, #/hr	6	0	10	10	0	6	23	0	22	22	0	23
Sign Control	Stop	Stop	Stop	Stop	Stop	Stop	Free	Free	Free	Free	Free	Free
RT Channelized	-	-	None	-	-	None	-	-	None	-	-	None
Storage Length	-	-	-	-	-	-	-	-	-	-	-	65
Veh in Median Storage, #	-	0	-	-	0	-	-	0	-	-	0	-
Grade, %	-	0	-	-	0	-	-	0	-	-	0	-
Peak Hour Factor	68	68	68	94	94	94	89	89	89	96	96	96
Heavy Vehicles, %	20	0	0	0	0	7	0	1	0	12	1	0
Mvmt Flow	10	9	21	17	13	161	15	628	39	179	685	34

Major/Minor	Minor2		Minor1		Major1			Major2				
Conflicting Flow All	1854	1802	393	1415	1800	676	742	0	0	689	0	0
Stage 1	1083	1083	-	700	700	-	-	-	-	-	-	-
Stage 2	771	719	-	715	1100	-	-	-	-	-	-	-
Critical Hdwy	7.6	6.5	6.9	7.3	6.5	6.305	4.1	-	-	4.28	-	-
Critical Hdwy Stg 1	6.8	5.5	-	6.1	5.5	-	-	-	-	-	-	-
Critical Hdwy Stg 2	6.4	5.5	-	6.5	5.5	-	-	-	-	-	-	-
Follow-up Hdwy	3.69	4	3.3	3.5	4.3	3.665	2.2	-	-	2.314	-	-
Pot Cap-1 Maneuver	44	80	612	107	81	442	874	-	-	849	-	-
Stage 1	209	296	-	433	444	-	-	-	-	-	-	-
Stage 2	358	436	-	392	290	-	-	-	-	-	-	-
Platoon blocked, %								-	-	-	-	-
Mov Cap-1 Maneuver	15	48	595	62	49	432	857	-	-	833	-	-
Mov Cap-2 Maneuver	15	48	-	62	49	-	-	-	-	-	-	-
Stage 1	199	186	-	413	424	-	-	-	-	-	-	-
Stage 2	211	416	-	229	182	-	-	-	-	-	-	-

Approach	EB		WB		NB		SB	
HCM Control Delay, s	248.5		87.4		0.2		3	
HCM LOS	F		F					

Minor Lane/Major Mvmt	NBL	NBT	NBR	EBLn1	WBLn1	SBL	SBT	SBR
Capacity (veh/h)	857	-	-	44	210	833	-	-
HCM Lane V/C Ratio	0.017	-	-	0.902	0.907	0.215	-	-
HCM Control Delay (s)	9.3	0	-	248.5	87.4	10.5	1.2	-
HCM Lane LOS	A	A	-	F	F	B	A	-
HCM 95th %tile Q(veh)	0.1	-	-	3.6	7.3	0.8	-	-

Intersection	
Intersection Delay, s/veh	118.4
Intersection LOS	F

Movement	EBL	EBT	EBR	WBL	WBT	WBR	NBL	NBT	NBR	SBL	SBT	SBR
Lane Configurations		↕			↕			↕			↕	
Traffic Vol, veh/h	16	122	18	72	119	158	22	364	68	172	330	16
Future Vol, veh/h	16	122	18	72	119	158	22	364	68	172	330	16
Peak Hour Factor	0.85	0.85	0.85	0.85	0.85	0.85	0.89	0.89	0.89	0.85	0.85	0.85
Heavy Vehicles, %	0	6	0	0	5	1	0	0	0	0	0	0
Mvmt Flow	19	144	21	85	140	186	25	409	76	202	388	19
Number of Lanes	0	1	0	0	1	0	0	1	0	0	1	0

Approach	EB	WB	NB	SB
Opposing Approach	WB	EB	SB	NB
Opposing Lanes	1	1	1	1
Conflicting Approach Left	SB	NB	EB	WB
Conflicting Lanes Left	1	1	1	1
Conflicting Approach Right	NB	SB	WB	EB
Conflicting Lanes Right	1	1	1	1
HCM Control Delay	22.9	55.7	108.3	197.8
HCM LOS	C	F	F	F

Lane	NBLn1	EBLn1	WBLn1	SBLn1
Vol Left, %	5%	10%	21%	33%
Vol Thru, %	80%	78%	34%	64%
Vol Right, %	15%	12%	45%	3%
Sign Control	Stop	Stop	Stop	Stop
Traffic Vol by Lane	454	156	349	518
LT Vol	22	16	72	172
Through Vol	364	122	119	330
RT Vol	68	18	158	16
Lane Flow Rate	510	184	411	609
Geometry Grp	1	1	1	1
Degree of Util (X)	1.114	0.472	0.909	1.353
Departure Headway (Hd)	8.725	10.689	9.035	8.417
Convergence, Y/N	Yes	Yes	Yes	Yes
Cap	418	340	406	439
Service Time	6.725	8.689	7.035	6.417
HCM Lane V/C Ratio	1.22	0.541	1.012	1.387
HCM Control Delay	108.3	22.9	55.7	197.8
HCM Lane LOS	F	C	F	F
HCM 95th-tile Q	16.4	2.4	9.6	26.9

## APPENDIX F – LOS SUMMARY TABLES

Background 2030						
Intersection	Am Peak Hour			PM Peak Hour		
	LOS	v/c Ratio	Delay (Sec)	LOS	v/c Ratio	Delay (Sec)
Drummond Concession 2 at Perthmore Street						
Eastbound Left-Through	A	0.02	8.30	A	0.03	8.00
Westbound Through	-	-	-	-	-	-
Westbound Right	-	-	-	-	-	-
Southbound Left-Right	B	0.06	10.40	B	0.07	10.20
Isabella Street at Victoria Street						
Eastbound Through-Right	-	-	-	-	-	-
Westbound Left-through	A	0.02	8.00	A	0.02	7.50
Northbound Left-Right	B	0.33	12.50	A	0.04	9.70
North Street at Wilson Street						
Eastbound Left-Through-Right	D	0.17	29.70	F	0.39	68.70
Westbound Left-Through-Right	C	0.25	15.80	D	0.54	30.90
Northbound Left-Through-Right	A	0.01	8.70	A	0.02	8.90
Southbound Left-Through	A	0.11	9.10	A	0.17	9.80
Southbound Through-Right	A	-	0.50	A	-	0.80
North Street at Drummond Street						
Eastbound Left-Through-Right	B	0.34	13.70	C	0.35	16.00
Westbound Left-Through-Right	C	0.50	16.00	D	0.70	25.60
Northbound Left-Through-Right	C	0.52	16.10	E	0.86	38.10
Southbound Left-Through-Right	D	0.81	30.40	F	1.03	78.70
Wilson Street at HWY. 7						
Eastbound Left-Through-Right	E	1.01	65.40	F	1.10	89.40
Westbound Left-Through-Right	C	0.87	33.80	C	0.86	28.90
Northbound Left-Through	D	0.87	48.30	D	0.74	38.50
Northbound Right	A	0.33	4.00	A	0.40	4.50
Southbound Left-Through	D	0.43	39.10	D	0.47	44.10
Southbound Right	A	0.25	7.30	A	0.30	8.50
Drummond Street at HWY. 7						
Eastbound Left-Through-Right	C	0.80	28.30	C	0.92	33.30
Westbound Left-Through	B	0.63	16.30	B	0.63	15.60
Westbound Right	A	0.03	1.90	A	0.01	0.00
Northbound Left	D	0.82	47.40	D	0.81	46.70
Northbound Through-Right	B	0.35	12.80	A	0.29	7.60
Southbound Left	C	0.07	22.50	C	0.05	23.10
Southbound Through-Right	B	0.34	14.20	A	0.23	9.60
Sunset Blvd at Wilson Street						
Eastbound Left-Through	C	0.56	24.20	C	0.58	25.90
Eastbound Right	A	0.51	5.90	A	0.47	7.10
Westbound Left-Through-Right	B	0.25	14.40	B	0.27	13.30
Northbound Left	A	0.36	9.10	B	0.44	12.20
Northbound Through-Right	B	0.53	12.50	C	0.79	21.30
Southbound Left	A	0.01	6.20	A	0.06	6.70
Southbound through	C	0.78	24.70	E	1.04	65.00
Southbound Right	A	0.11	1.60	A	0.12	2.20
Leslie Street/Isabella Street at Wilson Street						
Eastbound Left-Through-Right	B	0.17	17.80	E	0.92	70.90
Westbound Left-Through-Right	B	0.29	10.50	B	0.43	14.70
Northbound-Left	*	*	*	A	0.01	3.70
Northbound Through-Right	B	0.49	10.80	B	0.62	12.20
Southbound Left	A	0.10	4.40	A	0.12	4.20
Southbound Through-Right	A	0.57	8.20	B	0.83	18.80

**Background Traffic Only Horizon Year 2035**

Intersection	Am Peak Hour			PM Peak Hour		
	LOS	v/c Ratio	Delay (Sec)	LOS	v/c Ratio	Delay (Sec)
<b>Drummond Concession 2 at Perthmore Street</b>						
Eastbound Left-Through	A	0.02	8.50	A	0.03	8.10
Westbound Through	-	-	-	-	-	-
Westbound Right	-	-	-	-	-	-
Southbound Left-Right	B	0.07	10.80	B	0.08	10.60
<b>Isabella Street at Victoria Street</b>						
Eastbound Through-Right	-	-	-	-	-	-
Westbound Left-through	A	0.02	8.00	A	0.02	7.50
Northbound Left-Right	B	0.39	13.70	A	0.05	9.90
<b>North Street at Wilson Street</b>						
Eastbound Left-Through-Right	E	0.27	42.70	F	0.81	204.90
Westbound Left-Through-Right	C	0.32	18.60	F	0.82	68.20
Northbound Left-Through-Right	A	0.01	9.00	A	0.02	9.30
Southbound Left-Through	A	0.13	9.50	B	0.20	10.40
Southbound Through-Right	A	-	0.70	A	-	1.20
<b>North Street at Drummond Street</b>						
Eastbound Left-Through-Right	C	0.44	16.90	C	0.46	19.90
Westbound Left-Through-Right	C	0.64	22.10	E	0.89	40.40
Northbound Left-Through-Right	C	0.66	22.70	F	1.10	16.20
Southbound Left-Through-Right	F	1.01	71.60	F	1.30	171.60
<b>Wilson Street at HWY. 7</b>						
Eastbound Left-Through-Right	F	1.26	160.30	F	1.35	192.30
Westbound Left-Through-Right	E	1.18	60.70	D	1.00	51.40
Northbound Left-Through	E	0.96	61.30	D	0.79	40.90
Northbound Right	A	0.36	4.80	A	0.42	4.30
Southbound Left-Through	D	0.44	39.20	D	0.48	43.10
Southbound Right	A	0.25	6.70	A	0.30	7.70
<b>Drummond Street at HWY. 7</b>						
Eastbound Left-Through-Right	C	0.84	31.80	E	1.05	65.40
Westbound Left-Through	B	0.72	19.50	B	1.03	19.00
Westbound Right	A	0.03	2.50	A	0.01	0.00
Northbound Left	F	1.01	87.60	E	0.88	56.10
Northbound Through-Right	B	0.39	14.90	A	0.31	7.30
Southbound Left	C	0.08	23.70	C	0.06	23.20
Southbound Through-Right	B	0.38	16.30	A	0.24	9.20
<b>Sunset Blvd at Wilson Street</b>						
Eastbound Left-Through	C	0.65	28.50	C	0.66	29.50
Eastbound Left	A	0.59	9.30	A	0.53	9.40
Westbound Left-Through-Right	B	0.28	15.30	B	0.30	14.00
Northbound Left	B	0.43	10.90	B	0.50	14.90
Northbound Through-Right	B	0.58	14.40	C	0.91	29.80
Southbound Left	A	0.02	6.30	A	0.07	6.80
Southbound through	C	0.85	29.50	F	1.19	120.20
Southbound Right	A	0.12	2.00	A	0.13	2.90
<b>Leslie Street/Isabella Street at Wilson Street</b>						
Eastbound Left-Through-Right	C	0.28	24.60	F	1.15	139.80
Westbound Left-Through-Right	B	0.41	13.70	B	0.50	17.30
Northbound-Left	*	*	*	A	0.01	3.30
Northbound Through-Right	B	0.51	10.90	B	0.74	16.80
Southbound Left	A	0.11	3.80	A	0.16	4.50
Southbound Through-Right	A	0.58	7.40	C	0.92	26.70

**Total Traffic Horizon Year 2030**

Intersection	Am Peak Hour			PM Peak Hour		
	LOS	v/c Ratio	Delay (Sec)	LOS	v/c Ratio	Delay (Sec)
<b>Drummond Concession 2 at Perthmore Street</b>						
Eastbound Left-Through	A	0.03	8.40	A	0.06	8.10
Westbound Through	-	-	-	-	-	-
Westbound Right	-	-	-	-	-	-
Southbound Left-Right	B	0.13	10.80	B	0.12	10.80
<b>Isabella Street at Victoria Street</b>						
Eastbound Through-Right	-	-	-	-	-	-
Westbound Left-through	A	0.03	8.00	A	0.02	7.50
Northbound Left-Right	B	0.34	13.00	A	0.05	9.70
<b>North Street at Wilson Street</b>						
Eastbound Left-Through-Right	D	0.18	31.00	F	0.43	77.20
Westbound Left-Through-Right	C	0.30	17.20	E	0.61	35.90
Northbound Left-Through-Right	A	0.01	8.70	A	0.02	8.90
Southbound Left-Through	A	0.11	9.20	A	0.18	9.90
Southbound Through-Right	A	-	0.50	A	-	0.90
<b>North Street at Drummond Street</b>						
Eastbound Left-Through-Right	B	0.37	14.90	C	0.42	18.30
Westbound Left-Through-Right	C	0.60	19.90	D	0.81	34.10
Northbound Left-Through-Right	C	0.56	18.20	F	0.96	53.70
Southbound Left-Through-Right	E	0.85	38.50	F	1.11	106.30
<b>Wilson Street at HWY. 7</b>						
Eastbound Left	C	0.28	25.50	C	0.24	22.50
Eastbound Through	C	0.44	24.30	C	0.63	24.10
Eastbound Right	A	0.41	4.40	A	0.22	4.20
Westbound Left	B	0.52	18.50	B	0.42	14.50
Westbound Through	B	0.41	18.30	B	0.44	15.50
Westbound Right	A	0.02	0.10	A	0.01	0.00
Northbound Left-Through	D	0.89	48.30	D	0.79	41.20
Northbound Right	A	0.33	3.90	A	0.43	8.10
Southbound Left-Through	C	0.27	21.40	C	0.27	23.50
Southbound Right	A	0.17	6.80	A	0.18	4.80
<b>Drummond Street at HWY. 7</b>						
Eastbound Left	C	0.41	26.20	C	0.30	22.50
Eastbound Through	C	0.40	20.70	C	0.56	21.50
Eastbound Right	A	0.37	4.80	A	0.51	4.70
Westbound Left	B	0.27	11.50	B	0.33	11.30
Westbound Through-Right	B	0.41	14.00	B	0.36	12.00
Northbound Left	C	0.70	26.20	C	0.71	29.30
Northbound Through-Right	A	0.31	6.90	A	0.28	6.10
Southbound Left	C	0.12	25.40	C	0.08	25.40
Southbound Through-Right	B	0.55	19.70	B	0.32	12.30
<b>Sunset Blvd at Wilson Street</b>						
Eastbound Left-Through	C	0.55	23.80	C	0.57	25.70
Eastbound Left	A	0.51	6.10	A	0.48	7.40
Westbound Left-Through-Right	B	0.25	14.40	B	0.27	13.30
Northbound Left	A	0.38	9.40	B	0.45	12.60
Northbound Through-Right	B	0.54	12.70	C	0.80	21.60
Southbound Left	A	0.01	6.20	A	0.06	6.70
Southbound through	C	0.79	25.00	E	1.05	68.70
Southbound Right	A	0.11	1.60	A	0.12	2.20
<b>Leslie Street/Isabella Street at Wilson Street</b>						
Eastbound Left-Through-Right	B	0.17	18.20	F	0.96	80.80
Westbound Left-Through-Right	B	0.30	10.60	B	0.44	14.90
Northbound-Left	*	*	*	A	0.01	3.70
Northbound Through-Right	B	0.50	10.80	B	0.66	14.20
Southbound Left	A	0.11	4.40	A	0.13	4.30
Southbound Through-Right	A	0.57	8.20	B	0.83	18.70



**Total Traffic Horizon Year 2035**

Intersection	Am Peak Hour			PM Peak Hour		
	LOS	v/c Ratio	Delay (Sec)	LOS	v/c Ratio	Delay (Sec)
<b>Drummond Concession 2 at Perthmore Street</b>						
Eastbound Left-Through	A	0.03	8.50	A	0.06	8.20
Westbound Through	-	-	-	-	-	-
Westbound Right	-	-	-	-	-	-
Southbound Left-Right	B	0.14	11.20	B	0.15	11.40
<b>Isabella Street at Victoria Street</b>						
Eastbound Through-Right	-	-	-	-	-	-
Westbound Left-through	A	0.03	8.10	A	0.02	7.50
Northbound Left-Right	B	0.41	14.30	A	0.06	9.90
<b>North Street at Wilson Street</b>						
Eastbound Left-Through-Right	E	0.29	45.60	F	0.90	248.50
Westbound Left-Through-Right	C	0.38	20.90	F	0.91	87.40
Northbound Left-Through-Right	A	0.01	9.00	A	0.02	9.30
Southbound Left-Through	A	0.13	9.50	B	0.22	10.50
Southbound Through-Right	A	-	0.70	A	-	1.20
<b>North Street at Drummond Street</b>						
Eastbound Left-Through-Right	C	0.47	18.30	C	0.54	22.90
Westbound Left-Through-Right	D	0.75	28.30	F	1.01	55.70
Northbound Left-Through-Right	D	0.71	25.70	F	1.22	108.30
Southbound Left-Through-Right	F	1.06	88.60	F	1.39	197.80
<b>Wilson Street at HWY. 7</b>						
Eastbound Left	C	0.34	27.10	C	0.35	33.20
Eastbound Through	C	0.48	25.60	D	0.82	38.30
Eastbound Right	A	0.45	4.40	A	0.27	6.60
Westbound Left	C	0.66	24.10	B	0.48	19.40
Westbound Through	B	0.47	19.70	B	0.50	19.10
Westbound Right	A	0.02	0.10	A	0.01	0.00
Northbound Left-Through	E	0.99	68.70	D	0.80	41.50
Northbound Right	A	0.35	3.80	A	0.42	4.20
Southbound Left-Through	C	0.35	23.70	D	0.47	42.60
Southbound Right	A	0.19	7.80	B	0.31	11.90
<b>Drummond Street at HWY. 7</b>						
Eastbound Left	C	0.42	25.60	C	0.36	22.70
Eastbound Through	B	0.38	19.70	C	0.63	21.80
Eastbound Right	A	0.36	4.20	A	0.57	5.80
Westbound Left	B	0.31	11.50	B	0.42	12.70
Westbound Through-Right	B	0.42	13.70	B	0.39	12.10
Northbound Left	E	0.94	57.90	D	0.85	42.50
Northbound Through-Right	A	0.37	8.80	A	0.31	6.20
Southbound Left	C	0.14	28.10	C	0.10	26.10
Southbound Through-Right	C	0.63	24.40	B	0.36	12.60
<b>Sunset Blvd at Wilson Street</b>						
Eastbound Left-Through	C	0.65	27.90	C	0.66	29.10
Eastbound Left	A	0.60	9.50	A	0.54	9.90
Westbound Left-Through-Right	B	0.28	15.20	B	0.30	14.00
Northbound Left	B	0.49	12.10	B	0.51	15.60
Northbound Through-Right	B	0.59	14.60	C	0.91	30.50
Southbound Left	A	0.02	6.30	A	0.07	6.80
Southbound through	C	0.85	29.70	F	1.20	124.90
Southbound Right	A	0.12	2.00	A	0.13	2.90
<b>Leslie Street/Isabella Street at Wilson Street</b>						
Eastbound Left-Through-Right	C	0.21	20.80	F	1.19	155.10
Westbound Left-Through-Right	B	0.34	11.80	B	0.51	17.50
Northbound-Left	*	*	*	A	0.01	3.30
Northbound Through-Right	B	0.56	12.60	B	0.73	16.70
Southbound Left	A	0.12	4.20	A	0.17	4.60
Southbound Through-Right	A	0.62	8.50	C	0.92	27.00

## APPENDIX G – MITIGATION MEASURES

# Signal Warrant Calculation

MAJOR STREET:

MINOR STREET:

COMMENT:

NUMBER OF APPROACH LANES: 1  2

TEE INTERSECTION CONFIGURATION YES  NO

FLOW CONDITIONS: FREE FLOW (RURAL)   
RESTRICTED FLOW (URBAN)

VOLUME	AM	PM	FACTOR *	
1A - All	795	975	n/a	814
1B - Minor	287	321	92%	280
2A - Major	508	654	92%	535
2B - Cross	138	139	92%	127

\* This factor relates average of the "peak eight hours" to the average of the "am and pm peak hours"

OVERALL WARRANT	150% SATISFIED:	YES <input type="checkbox"/>	NO <input checked="" type="checkbox"/>	Warrant for new intersection with forecast traffic
	120% SATISFIED:	YES <input type="checkbox"/>	NO <input checked="" type="checkbox"/>	Warrant for existing intersection with forecast traffic
	100% SATISFIED:	YES <input checked="" type="checkbox"/>	NO <input type="checkbox"/>	Warrant for existing intersection with existing traffic *
	COMBO 80% SATISFIED:	YES <input type="checkbox"/>	NO <input checked="" type="checkbox"/>	Warrant for existing intersection with existing traffic
	80% SATISFIED:	YES <input checked="" type="checkbox"/>	NO <input type="checkbox"/>	

\* Consider full underground provisions if 100% for forecast traffic

## WARRANT 1 - MINIMUM VEHICULAR VOLUME

APPROACH LANES	1		2 OR MORE		AVERAGE HOUR PERIOD
	FREE FLOW	REST. FLOW	FREE FLOW	REST. FLOW	
FLOW CONDITION		X			
ALL APPROACHES	480	720	600	900	814
	% FULFILLED				113%

150% SATISFIED: YES  NO   
 120% SATISFIED: YES  NO   
 100% SATISFIED: YES  NO   
 80% SATISFIED: YES  NO

APPROACH LANES	1		2 OR MORE		AVERAGE HOUR PERIOD
	FREE FLOW	REST. FLOW	FREE FLOW	REST. FLOW	
FLOW CONDITION		X			
MINOR STREET APPROACHES	120	170	120	170	280
	% FULFILLED				165%

## WARRANT 2 - DELAY TO CROSS TRAFFIC

APPROACH LANES	1		2 OR MORE		AVERAGE HOUR PERIOD
	FREE FLOW	REST. FLOW	FREE FLOW	REST. FLOW	
FLOW CONDITION		X			
MAJOR STREET APPROACHES	480	720	600	900	535
	% FULFILLED				74%

150% SATISFIED: YES  NO   
 120% SATISFIED: YES  NO   
 100% SATISFIED: YES  NO   
 80% SATISFIED: YES  NO

APPROACH LANES	1		2 OR MORE		AVERAGE HOUR PERIOD
	FREE FLOW	REST. FLOW	FREE FLOW	REST. FLOW	
FLOW CONDITION		X			
TRAFFIC CROSSING MAJOR STREET	50	75	50	75	127
	% FULFILLED				170%

1A - MINIMUM VEHICULAR VOLUME: Total vehicle volume on all approaches for average day

1B - MINIMUM VEHICULAR VOLUME: Total vehicle volume on minor streets

2A - DELAY TO CROSS TRAFFIC: Total vehicle volume on major street for average day

2B - DELAY TO CROSS TRAFFIC: Total vehicle and pedestrian volume crossing major street; comprising: (1) lefts from both minor streets, (2) heaviest through from minor street, (3) 50% of heavier left turn from major street when following criteria met: (a) left turn volume >120 and (b) left turn volume plus opposing volume > 720, (4) pedestrians crossing the major street.

# Signal Warrant Calculation

MAJOR STREET:

MINOR STREET:

COMMENT:

NUMBER OF APPROACH LANES: 1  2

TEE INTERSECTION CONFIGURATION: YES  NO

FLOW CONDITIONS: FREE FLOW (RURAL)   
RESTRICTED FLOW (URBAN)

VOLUME	AM	PM	FACTOR *	
1A - All	801	1,141	n/a	893
1B - Minor	82	136	92%	100
2A - Major	719	1,005	92%	793
2B - Crossing	30	53	92%	38

\* This factor relates average of the "peak eight hours" to the average of the "am and pm peak hours"

OVERALL WARRANT

150% SATISFIED: YES  NO

120% SATISFIED: YES  NO

100% SATISFIED: YES  NO

COMBO 80% SATISFIED: YES  NO

80% SATISFIED: YES  NO

Warrant for new intersection with forecast traffic

Warrant for existing intersection with forecast traffic

Warrant for existing intersection with existing traffic \*

Warrant for existing intersection with existing traffic

\* Consider full underground provisions if 100% for forecast traffic

## WARRANT 1 - MINIMUM VEHICULAR VOLUME

APPROACH LANES	1		2 OR MORE		AVERAGE HOUR PERIOD
	FREE FLOW	REST. FLOW	FREE FLOW	REST. FLOW	
FLOW CONDITION		X			
ALL APPROACHES	480	720	600	900	893
% FULFILLED					124%

150% SATISFIED: YES  NO

120% SATISFIED: YES  NO

100% SATISFIED: YES  NO

80% SATISFIED: YES  NO

APPROACH LANES	1		2 OR MORE		AVERAGE HOUR PERIOD
	FREE FLOW	REST. FLOW	FREE FLOW	REST. FLOW	
FLOW CONDITION		X			
MINOR STREET APPROACHES	120	170	120	170	100
% FULFILLED					59%

## WARRANT 2 - DELAY TO CROSS TRAFFIC

APPROACH LANES	1		2 OR MORE		AVERAGE HOUR PERIOD
	FREE FLOW	REST. FLOW	FREE FLOW	REST. FLOW	
FLOW CONDITION		X			
MAJOR STREET APPROACHES	480	720	600	900	793
% FULFILLED					110%

150% SATISFIED: YES  NO

120% SATISFIED: YES  NO

100% SATISFIED: YES  NO

80% SATISFIED: YES  NO

APPROACH LANES	1		2 OR MORE		AVERAGE HOUR PERIOD
	FREE FLOW	REST. FLOW	FREE FLOW	REST. FLOW	
FLOW CONDITION		X			
TRAFFIC CROSSING MAJOR STREET	50	75	50	75	38
% FULFILLED					51%

1A - MINIMUM VEHICULAR VOLUME: Total vehicle volume on all approaches for average day

1B - MINIMUM VEHICULAR VOLUME: Total vehicle volume on minor streets

2A - DELAY TO CROSS TRAFFIC: Total vehicle volume on major street for average day

2B - DELAY TO CROSS TRAFFIC: Total vehicle and pedestrian volume crossing major street; comprising: (1) lefts from both minor streets, (2) heaviest through from minor street, (3) 50% of heavier left turn from major street when following criteria met: (a) left turn volume >120 and (b) left turn volume plus opposing volume > 720, (4) pedestrians crossing the major street.

# Signal Warrant Calculation

MAJOR STREET: Wilson Street

MINOR STREET: North Street

COMMENT: Horizon Year 2035 - Total Traffic Conditions

NUMBER OF APPROACH LANES: 1  2

TEE INTERSECTION CONFIGURATION YES  NO

FLOW CONDITIONS: FREE FLOW (RURAL)   
RESTRICTED FLOW (URBAN)

VOLUME	AM	PM	FACTOR *	
1A - All	1,233	1,745	n/a	1,370
1B - Minor	173	233	92%	187
2A - Major	1,060	1,512	92%	1,183
2B - Crossing	44	160	92%	94

\* This factor relates average of the "peak eight hours" to the average of the "am and pm peak hours"

OVERALL WARRANT

150% SATISFIED:	YES	<input type="checkbox"/>	NO	<input checked="" type="checkbox"/>	Warrant for new intersection with forecast traffic
120% SATISFIED:	YES	<input checked="" type="checkbox"/>	NO	<input type="checkbox"/>	Warrant for existing intersection with forecast traffic
100% SATISFIED:	YES	<input checked="" type="checkbox"/>	NO	<input type="checkbox"/>	Warrant for existing intersection with existing traffic *
COMBO 80% SATISFIED:	YES	<input checked="" type="checkbox"/>	NO	<input type="checkbox"/>	Warrant for existing intersection with existing traffic
80% SATISFIED:	YES	<input checked="" type="checkbox"/>	NO	<input type="checkbox"/>	

\* Consider full underground provisions if 100% for forecast traffic

## WARRANT 1 - MINIMUM VEHICULAR VOLUME

APPROACH LANES	1		2 OR MORE		AVERAGE HOUR PERIOD
	FREE FLOW	REST. FLOW	FREE FLOW	REST. FLOW	
FLOW CONDITION		X			
ALL APPROACHES	480	720	600	900	1370
% FULFILLED					190%

150% SATISFIED: YES  NO   
 120% SATISFIED: YES  NO   
 100% SATISFIED: YES  NO   
 80% SATISFIED: YES  NO

APPROACH LANES	1		2 OR MORE		AVERAGE HOUR PERIOD
	FREE FLOW	REST. FLOW	FREE FLOW	REST. FLOW	
FLOW CONDITION		X			
MINOR STREET APPROACHES	120	170	120	170	187
% FULFILLED					110%

## WARRANT 2 - DELAY TO CROSS TRAFFIC

APPROACH LANES	1		2 OR MORE		AVERAGE HOUR PERIOD
	FREE FLOW	REST. FLOW	FREE FLOW	REST. FLOW	
FLOW CONDITION		X			
MAJOR STREET APPROACHES	480	720	600	900	1183
% FULFILLED					164%

150% SATISFIED: YES  NO   
 120% SATISFIED: YES  NO   
 100% SATISFIED: YES  NO   
 80% SATISFIED: YES  NO

APPROACH LANES	1		2 OR MORE		AVERAGE HOUR PERIOD
	FREE FLOW	REST. FLOW	FREE FLOW	REST. FLOW	
FLOW CONDITION		X			
TRAFFIC CROSSING MAJOR STREET	50	75	50	75	94
% FULFILLED					125%

1A - MINIMUM VEHICULAR VOLUME: Total vehicle volume on all approaches for average day

1B - MINIMUM VEHICULAR VOLUME: Total vehicle volume on minor streets

2A - DELAY TO CROSS TRAFFIC: Total vehicle volume on major street for average day

2B - DELAY TO CROSS TRAFFIC: Total vehicle and pedestrian volume crossing major street; comprising: (1) lefts from both minor streets, (2) heaviest through from minor street, (3) 50% of heavier left turn from major street when following criteria met: (a) left turn volume >120 and (b) left turn volume plus opposing volume > 720, (4) pedestrians crossing the major street.

Perthmore Subdivision TIS  
7: Drummond Street & North Street

2035 Total Traffic Mitigations  
AM Peak Hour



Lane Group	EBL	EBT	EBR	WBL	WBT	WBR	NBL	NBT	NBR	SBL	SBT	SBR
Lane Configurations		↕			↕			↕			↕	
Traffic Volume (vph)	13	110	13	79	118	114	4	251	48	120	282	20
Future Volume (vph)	13	110	13	79	118	114	4	251	48	120	282	20
Ideal Flow (vphpl)	1900	1900	1900	1900	1900	1900	1900	1900	1900	1900	1900	1900
Lane Util. Factor	1.00	1.00	1.00	1.00	1.00	1.00	1.00	1.00	1.00	1.00	1.00	1.00
Ped Bike Factor		1.00			0.99			0.99			1.00	
Frt		0.987			0.950			0.979			0.994	
Flt Protected		0.995			0.987			0.999			0.986	
Satd. Flow (prot)	0	1648	0	0	1676	0	0	1809	0	0	1812	0
Flt Permitted		0.958			0.875			0.995			0.814	
Satd. Flow (perm)	0	1586	0	0	1485	0	0	1802	0	0	1492	0
Right Turn on Red			Yes			Yes			Yes			Yes
Satd. Flow (RTOR)		10			57			24			7	
Link Speed (k/h)		50			50			50			50	
Link Distance (m)		296.2			746.2			218.2			144.7	
Travel Time (s)		21.3			53.7			15.7			10.4	
Confl. Peds. (#/hr)	4		1	1		4	7		10	10		7
Peak Hour Factor	0.67	0.67	0.67	0.88	0.88	0.88	0.90	0.90	0.90	0.78	0.78	0.78
Heavy Vehicles (%)	0%	16%	0%	0%	14%	0%	0%	2%	3%	1%	3%	7%
Adj. Flow (vph)	19	164	19	90	134	130	4	279	53	154	362	26
Shared Lane Traffic (%)												
Lane Group Flow (vph)	0	202	0	0	354	0	0	336	0	0	542	0
Enter Blocked Intersection	No	No	No	No	No	No	No	No	No	No	No	No
Lane Alignment	Left	Left	Right	Left	Left	Right	Left	Left	Right	Left	Left	Right
Median Width(m)		0.0			0.0			0.0			0.0	
Link Offset(m)		0.0			0.0			0.0			0.0	
Crosswalk Width(m)		4.8			4.8			4.8			4.8	
Two way Left Turn Lane												
Headway Factor	1.00	1.00	1.00	1.00	1.00	1.00	1.00	1.00	1.00	1.00	1.00	1.00
Turning Speed (k/h)	25		15	25		15	25		15	25		15
Number of Detectors	1	2		1	2		1	2		1	2	
Detector Template	Left	Thru		Left	Thru		Left	Thru		Left	Thru	
Leading Detector (m)	2.0	10.0		2.0	10.0		2.0	10.0		2.0	10.0	
Trailing Detector (m)	0.0	0.0		0.0	0.0		0.0	0.0		0.0	0.0	
Detector 1 Position(m)	0.0	0.0		0.0	0.0		0.0	0.0		0.0	0.0	
Detector 1 Size(m)	2.0	0.6		2.0	0.6		2.0	0.6		2.0	0.6	
Detector 1 Type	Cl+Ex	Cl+Ex		Cl+Ex	Cl+Ex		Cl+Ex	Cl+Ex		Cl+Ex	Cl+Ex	
Detector 1 Channel												
Detector 1 Extend (s)	0.0	0.0		0.0	0.0		0.0	0.0		0.0	0.0	
Detector 1 Queue (s)	0.0	0.0		0.0	0.0		0.0	0.0		0.0	0.0	
Detector 1 Delay (s)	0.0	0.0		0.0	0.0		0.0	0.0		0.0	0.0	
Detector 2 Position(m)		9.4			9.4			9.4			9.4	
Detector 2 Size(m)		0.6			0.6			0.6			0.6	
Detector 2 Type		Cl+Ex			Cl+Ex			Cl+Ex			Cl+Ex	
Detector 2 Channel												
Detector 2 Extend (s)		0.0			0.0			0.0			0.0	
Turn Type	Perm	NA		Perm	NA		Perm	NA		Perm	NA	
Protected Phases		4			8			2			6	
Permitted Phases	4			8			2			6		

Perthmore Subdivision TIS  
7: Drummond Street & North Street

2035 Total Traffic Mitigations  
AM Peak Hour



Lane Group	EBL	EBT	EBR	WBL	WBT	WBR	NBL	NBT	NBR	SBL	SBT	SBR
Detector Phase	4	4		8	8		2	2		6	6	
Switch Phase												
Minimum Initial (s)	10.0	10.0		10.0	10.0		10.0	10.0		10.0	10.0	
Minimum Split (s)	22.6	22.6		22.6	22.6		22.6	22.6		22.6	22.6	
Total Split (s)	23.0	23.0		23.0	23.0		32.0	32.0		32.0	32.0	
Total Split (%)	41.8%	41.8%		41.8%	41.8%		58.2%	58.2%		58.2%	58.2%	
Maximum Green (s)	18.4	18.4		18.4	18.4		27.4	27.4		27.4	27.4	
Yellow Time (s)	3.3	3.3		3.3	3.3		3.3	3.3		3.3	3.3	
All-Red Time (s)	1.3	1.3		1.3	1.3		1.3	1.3		1.3	1.3	
Lost Time Adjust (s)		0.0			0.0			0.0			0.0	
Total Lost Time (s)		4.6			4.6			4.6			4.6	
Lead/Lag												
Lead-Lag Optimize?												
Vehicle Extension (s)	3.0	3.0		3.0	3.0		3.0	3.0		3.0	3.0	
Recall Mode	None	None		None	None		Max	Max		Max	Max	
Walk Time (s)	7.0	7.0		7.0	7.0		7.0	7.0		7.0	7.0	
Flash Dont Walk (s)	11.0	11.0		11.0	11.0		11.0	11.0		11.0	11.0	
Pedestrian Calls (#/hr)	0	0		0	0		0	0		0	0	
Act Effect Green (s)		14.9			14.9			27.5			27.5	
Actuated g/C Ratio		0.29			0.29			0.53			0.53	
v/c Ratio		0.44			0.76			0.35			0.68	
Control Delay		17.1			25.4			8.4			15.5	
Queue Delay		0.0			0.0			0.0			0.0	
Total Delay		17.1			25.4			8.4			15.5	
LOS		B			C			A			B	
Approach Delay		17.1			25.4			8.4			15.5	
Approach LOS		B			C			A			B	

Intersection Summary

Area Type:	Other
Cycle Length:	55
Actuated Cycle Length:	51.6
Natural Cycle:	55
Control Type:	Semi Act-Uncoord
Maximum v/c Ratio:	0.76
Intersection Signal Delay:	16.5
Intersection LOS:	B
Intersection Capacity Utilization:	80.8%
ICU Level of Service:	D
Analysis Period (min):	15

Splits and Phases: 7: Drummond Street & North Street

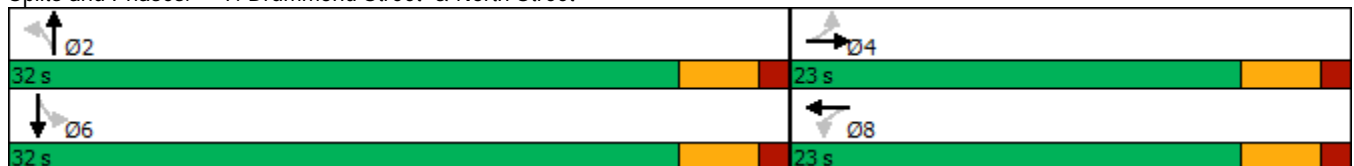

Perthmore Subdivision TIS  
 12: Wilson Street /Canadian tire Ent/Ext & HWY 7

2035 Total Traffic Mitigations  
 AM Peak Hour



Lane Group	EBL	EBT	EBR	WBL	WBT	WBR	NBL	NBT	NBR	SBL	SBT	SBR
Lane Configurations	↘	↑↑	↗	↘	↑↑	↗		↗	↗		↗	↗
Traffic Volume (vph)	80	550	315	251	689	14	391	80	256	55	78	122
Future Volume (vph)	80	550	315	251	689	14	391	80	256	55	78	122
Ideal Flow (vphpl)	1900	1900	1900	1900	1900	1900	1900	1900	1900	1900	1900	1900
Storage Length (m)	50.0		75.0	40.0		30.0	0.0		0.0	0.0		7.5
Storage Lanes	1		1	1		1	0		1	0		1
Taper Length (m)	7.5			7.5			7.5			10.0		
Lane Util. Factor	1.00	0.95	1.00	1.00	0.95	1.00	1.00	1.00	1.00	1.00	1.00	1.00
Ped Bike Factor									0.99		1.00	
Fr <sub>t</sub>			0.850			0.850			0.850			0.850
Fl <sub>t</sub> Protected	0.950			0.950			0.960			0.980		
Satd. Flow (prot)	1805	3505	1553	1805	3406	1538	0	1765	1509	0	1782	1583
Fl <sub>t</sub> Permitted	0.379			0.285			0.666			0.578		
Satd. Flow (perm)	720	3505	1553	542	3406	1538	0	1225	1487	0	1051	1583
Right Turn on Red			Yes			Yes			Yes			Yes
Satd. Flow (RTOR)			346			42			272			82
Link Speed (k/h)		60		60			50			50		
Link Distance (m)		455.2		323.0			474.1			562.7		
Travel Time (s)		27.3		19.4			34.1			40.5		
Confl. Peds. (#/hr)									2	2		
Peak Hour Factor	0.91	0.91	0.91	0.96	0.96	0.96	0.94	0.94	0.94	0.92	0.92	0.92
Heavy Vehicles (%)	0%	3%	4%	0%	6%	5%	4%	0%	7%	8%	2%	2%
Adj. Flow (vph)	88	604	346	261	718	15	416	85	272	60	85	133
Shared Lane Traffic (%)												
Lane Group Flow (vph)	88	604	346	261	718	15	0	501	272	0	145	133
Enter Blocked Intersection	No	No	No	No	No	No	No	No	No	No	No	No
Lane Alignment	Left	Left	Right	Left	Left	Right	Left	Left	Right	Left	Left	Right
Median Width(m)		3.6		3.6			0.0			0.0		
Link Offset(m)		0.0		0.0			0.0			0.0		
Crosswalk Width(m)		4.8		4.8			4.8			4.8		
Two way Left Turn Lane												
Headway Factor	1.00	1.00	1.00	1.00	1.00	1.00	1.00	1.00	1.00	1.00	1.00	1.00
Turning Speed (k/h)	25		15	25		15	25		15	25		15
Number of Detectors	1	2	1	1	2	1	1	1	1	1	1	1
Detector Template	Left		Right	Left		Right	Left			Left		
Leading Detector (m)	2.0	98.8	2.0	2.0	91.8	2.0	2.0	9.0	9.0	2.0	9.0	9.0
Trailing Detector (m)	0.0	-3.0	0.0	0.0	-3.0	0.0	0.0	-3.0	-3.0	0.0	-0.2	-3.0
Detector 1 Position(m)	0.0	-3.0	0.0	0.0	-3.0	0.0	0.0	-3.0	-3.0	0.0	-0.2	-3.0
Detector 1 Size(m)	2.0	12.0	2.0	2.0	12.0	2.0	2.0	12.0	12.0	2.0	9.2	12.0
Detector 1 Type	Cl+Ex	Cl+Ex	Cl+Ex	Cl+Ex	Cl+Ex	Cl+Ex	Cl+Ex	Cl+Ex	Cl+Ex	Cl+Ex	Cl+Ex	Cl+Ex
Detector 1 Channel												
Detector 1 Extend (s)	0.0	0.0	0.0	0.0	0.0	0.0	0.0	0.0	0.0	0.0	0.0	0.0
Detector 1 Queue (s)	0.0	0.0	0.0	0.0	0.0	0.0	0.0	0.0	0.0	0.0	0.0	0.0
Detector 1 Delay (s)	0.0	0.0	0.0	0.0	0.0	0.0	0.0	0.0	0.0	0.0	0.0	0.0
Detector 2 Position(m)		97.0		90.0								
Detector 2 Size(m)		1.8		1.8								
Detector 2 Type		Cl+Ex		Cl+Ex								
Detector 2 Channel												
Detector 2 Extend (s)		0.0		0.0								



Perthmore Subdivision TIS  
12: Wilson Street /Canadian tire Ent/Ext & HWY 7

2035 Total Traffic Mitigations  
AM Peak Hour



Lane Group	EBL	EBT	EBR	WBL	WBT	WBR	NBL	NBT	NBR	SBL	SBT	SBR
Turn Type	Perm	NA	Perm	pm+pt	NA	Perm	pm+pt	NA	Perm	Perm	NA	Perm
Protected Phases		2		1	6		3	8			4	
Permitted Phases	2		2	6		6	8		8	4		4
Detector Phase	2	2	2	1	6	6	3	8	8	4	4	4
Switch Phase												
Minimum Initial (s)	20.0	20.0	20.0	7.0	2.0	2.0	7.0	10.0	10.0	10.0	10.0	10.0
Minimum Split (s)	43.9	43.9	43.9	9.0	43.9	43.9	9.0	37.4	37.4	37.4	37.4	37.4
Total Split (s)	48.0	48.0	48.0	15.0	63.0	63.0	9.0	77.0	77.0	68.0	68.0	68.0
Total Split (%)	34.3%	34.3%	34.3%	10.7%	45.0%	45.0%	6.4%	55.0%	55.0%	48.6%	48.6%	48.6%
Maximum Green (s)	41.1	41.1	41.1	13.0	56.1	56.1	7.0	70.6	70.6	61.6	61.6	61.6
Yellow Time (s)	5.0	5.0	5.0	2.0	5.0	5.0	2.0	4.1	4.1	4.1	4.1	4.1
All-Red Time (s)	1.9	1.9	1.9	0.0	1.9	1.9	0.0	2.3	2.3	2.3	2.3	2.3
Lost Time Adjust (s)	0.0	0.0	0.0	0.0	0.0	0.0		0.0	0.0		0.0	0.0
Total Lost Time (s)	6.9	6.9	6.9	2.0	6.9	6.9		6.4	6.4		6.4	6.4
Lead/Lag	Lag	Lag	Lag	Lead			Lead			Lag	Lag	Lag
Lead-Lag Optimize?	Yes	Yes	Yes	Yes			Yes			Yes	Yes	Yes
Vehicle Extension (s)	4.5	4.5	4.5	2.0	4.5	4.5	2.0	3.0	3.0	3.0	3.0	3.0
Recall Mode	Min	Min	Min	None	Min	Min	None	None	None	None	None	None
Walk Time (s)	7.0	7.0	7.0		7.0	7.0		7.0	7.0	7.0	7.0	7.0
Flash Dont Walk (s)	30.0	30.0	30.0		30.0	30.0		24.0	24.0	24.0	24.0	24.0
Pedestrian Calls (#/hr)	0	0	0		0	0		1	1	0	0	0
Act Effct Green (s)	38.7	38.7	38.7	58.2	53.2	53.2		57.3	57.3		57.3	57.3
Actuated g/C Ratio	0.31	0.31	0.31	0.47	0.43	0.43		0.46	0.46		0.46	0.46
v/c Ratio	0.39	0.55	0.48	0.69	0.49	0.02		0.89	0.33		0.30	0.17
Control Delay	43.9	39.6	6.1	34.2	28.7	0.1		49.6	3.2		22.7	8.5
Queue Delay	0.0	0.0	0.0	0.0	0.0	0.0		0.0	0.0		0.0	0.0
Total Delay	43.9	39.6	6.1	34.2	28.7	0.1		49.6	3.2		22.7	8.5
LOS	D	D	A	C	C	A		D	A		C	A
Approach Delay		28.8			29.7			33.2			15.9	
Approach LOS		C			C			C			B	

Intersection Summary

Area Type: Other  
 Cycle Length: 140  
 Actuated Cycle Length: 124.2  
 Natural Cycle: 100  
 Control Type: Semi Act-Uncoord  
 Maximum v/c Ratio: 0.89  
 Intersection Signal Delay: 29.1  
 Intersection Capacity Utilization 85.1%  
 Analysis Period (min) 15  
 Intersection LOS: C  
 ICU Level of Service E

Splits and Phases: 12: Wilson Street /Canadian tire Ent/Ext & HWY 7

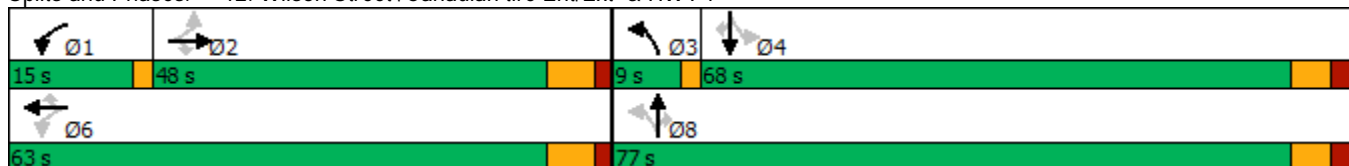

Perthmore Subdivision TIS  
15: Drummond Street/Dufferin Street & HWY 7

2035 Total Traffic Mitigations  
AM Peak Hour



Lane Group	EBL	EBT	EBR	WBL	WBT	WBR	NBL	NBT	NBR	SBL	SBT	SBR
Lane Configurations												
Traffic Volume (vph)	98	423	245	139	592	23	297	68	147	19	65	113
Future Volume (vph)	98	423	245	139	592	23	297	68	147	19	65	113
Ideal Flow (vphpl)	1900	1900	1900	1900	1900	1900	1900	1900	1900	1900	1900	1900
Storage Length (m)	30.0		45.0	30.0		15.0	65.0		0.0	40.0		0.0
Storage Lanes	1		1	1		0	1		0	1		0
Taper Length (m)	7.5			7.5			0.0			20.0		
Lane Util. Factor	1.00	0.95	1.00	1.00	0.95	0.95	1.00	1.00	1.00	1.00	1.00	1.00
Ped Bike Factor								0.99		1.00		
Frt			0.850		0.994			0.897				0.905
Flt Protected	0.950			0.950			0.950			0.950		
Satd. Flow (prot)	1736	3374	1583	1752	3287	0	1770	1655	0	1671	1678	0
Flt Permitted	0.392			0.406			0.309			0.606		
Satd. Flow (perm)	716	3374	1583	749	3287	0	576	1655	0	1065	1678	0
Right Turn on Red			Yes			Yes			Yes			Yes
Satd. Flow (RTOR)			269		4			141				81
Link Speed (k/h)		60			60			50				50
Link Distance (m)		323.0			147.8			376.3				173.7
Travel Time (s)		19.4			8.9			27.1				12.5
Confl. Peds. (#/hr)									2	2		
Peak Hour Factor	0.91	0.91	0.91	0.90	0.90	0.90	0.87	0.87	0.87	0.77	0.77	0.77
Heavy Vehicles (%)	4%	7%	2%	3%	9%	13%	2%	2%	2%	8%	5%	1%
Adj. Flow (vph)	108	465	269	154	658	26	341	78	169	25	84	147
Shared Lane Traffic (%)												
Lane Group Flow (vph)	108	465	269	154	684	0	341	247	0	25	231	0
Enter Blocked Intersection	No	No	No	No	No	No	No	No	No	No	No	No
Lane Alignment	Left	Left	Right	Left	Left	Right	Left	Left	Right	Left	Left	Right
Median Width(m)		3.6			3.6			3.6				3.6
Link Offset(m)		0.0			0.0			0.0				0.0
Crosswalk Width(m)		4.8			4.8			4.8				4.8
Two way Left Turn Lane												
Headway Factor	1.00	1.00	1.00	1.00	1.00	1.00	1.00	1.00	1.00	1.00	1.00	1.00
Turning Speed (k/h)	25		15	25		15	25		15	25		15
Number of Detectors	1	1	1	1	2		1	1		1	1	
Detector Template	Left		Right	Left								
Leading Detector (m)	2.0	94.8	2.0	2.0	86.8		9.0	9.0		9.0	9.0	
Trailing Detector (m)	0.0	93.0	0.0	0.0	-1.0		-3.0	-3.0		-3.0	-3.0	
Detector 1 Position(m)	0.0	93.0	0.0	0.0	-1.0		-3.0	-3.0		-3.0	-3.0	
Detector 1 Size(m)	2.0	1.8	2.0	2.0	12.0		12.0	12.0		12.0	12.0	
Detector 1 Type	Cl+Ex	Cl+Ex	Cl+Ex	Cl+Ex	Cl+Ex		Cl+Ex	Cl+Ex		Cl+Ex	Cl+Ex	
Detector 1 Channel												
Detector 1 Extend (s)	0.0	0.0	0.0	0.0	0.0		0.0	0.0		0.0	0.0	
Detector 1 Queue (s)	0.0	0.0	0.0	0.0	0.0		0.0	0.0		0.0	0.0	
Detector 1 Delay (s)	0.0	0.0	0.0	0.0	0.0		0.0	0.0		0.0	0.0	
Detector 2 Position(m)					85.0							
Detector 2 Size(m)					1.8							
Detector 2 Type					Cl+Ex							
Detector 2 Channel												
Detector 2 Extend (s)					0.0							

Perthmore Subdivision TIS  
15: Drummond Street/Dufferin Street & HWY 7

2035 Total Traffic Mitigations  
AM Peak Hour



Lane Group	EBL	EBT	EBR	WBL	WBT	WBR	NBL	NBT	NBR	SBL	SBT	SBR
Turn Type	Perm	NA	Perm	pm+pt	NA		pm+pt	NA		Perm	NA	
Protected Phases		2		1	6		3	8				4
Permitted Phases	2		2	6			8			4		
Detector Phase	2	2	2	1	6		3	8		4		4
Switch Phase												
Minimum Initial (s)	20.0	20.0	20.0	7.0	20.0		5.0	10.0		10.0		10.0
Minimum Split (s)	33.3	33.3	33.3	10.0	36.3		9.5	38.3		38.3		38.3
Total Split (s)	39.1	39.1	39.1	10.0	49.1		22.6	60.9		38.3		38.3
Total Split (%)	35.5%	35.5%	35.5%	9.1%	44.6%		20.5%	55.4%		34.8%		34.8%
Maximum Green (s)	32.8	32.8	32.8	7.0	42.8		18.1	54.6		32.0		32.0
Yellow Time (s)	5.0	5.0	5.0	3.0	5.0		3.5	4.1		4.1		4.1
All-Red Time (s)	1.3	1.3	1.3	0.0	1.3		1.0	2.2		2.2		2.2
Lost Time Adjust (s)	0.0	0.0	0.0	0.0	0.0		0.0	0.0		0.0		0.0
Total Lost Time (s)	6.3	6.3	6.3	3.0	6.3		4.5	6.3		6.3		6.3
Lead/Lag	Lag	Lag	Lag	Lead			Lead			Lag		Lag
Lead-Lag Optimize?	Yes	Yes	Yes	Yes			Yes			Yes		Yes
Vehicle Extension (s)	4.6	4.6	4.6	3.0	4.6		3.0	3.0		3.0		3.0
Recall Mode	Max	Max	Max	None	Max		None	None		None		None
Walk Time (s)	7.0	7.0	7.0		7.0			7.0		7.0		7.0
Flash Dont Walk (s)	20.0	20.0	20.0		20.0			25.0		25.0		25.0
Pedestrian Calls (#/hr)	0	0	0		0			1		0		0
Act Effct Green (s)	32.9	32.9	32.9	46.3	43.0		37.5	35.7		14.6		14.6
Actuated g/C Ratio	0.36	0.36	0.36	0.51	0.47		0.41	0.39		0.16		0.16
v/c Ratio	0.42	0.38	0.36	0.34	0.44		0.75	0.34		0.15		0.69
Control Delay	30.2	23.8	4.6	15.8	18.1		30.8	9.3		34.8		34.4
Queue Delay	0.0	0.0	0.0	0.0	0.0		0.0	0.0		0.0		0.0
Total Delay	30.2	23.8	4.6	15.8	18.1		30.8	9.3		34.8		34.4
LOS	C	C	A	B	B		C	A		C		C
Approach Delay		18.5			17.7			21.8				34.5
Approach LOS		B			B			C				C

Intersection Summary

Area Type:	Other
Cycle Length:	110
Actuated Cycle Length:	91.3
Natural Cycle:	95
Control Type:	Semi Act-Uncoord
Maximum v/c Ratio:	0.75
Intersection Signal Delay:	20.6
Intersection LOS:	C
Intersection Capacity Utilization:	80.1%
ICU Level of Service:	D
Analysis Period (min):	15

Splits and Phases: 15: Drummond Street/Dufferin Street & HWY 7

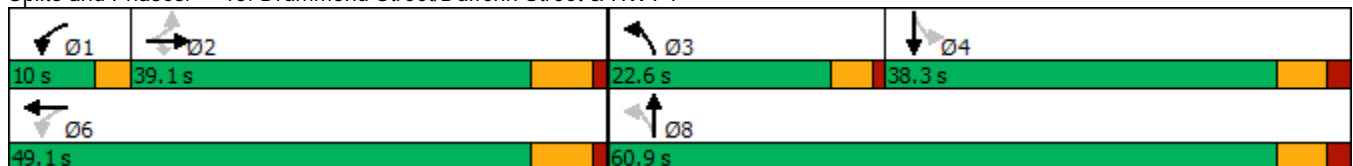

Perthmore Subdivision TIS  
26: Wilson Street & Sunset Boulevard

2035 Total Traffic Mitigations  
AM Peak Hour



Lane Group	EBL	EBT	EBR	WBL	WBT	WBR	NBL	NBT	NBR	SBL	SBT	SBR
Lane Configurations		↖	↗		↔		↖	↗		↖	↗	↖
Traffic Volume (vph)	107	17	204	13	54	22	135	450	0	6	525	67
Future Volume (vph)	107	17	204	13	54	22	135	450	0	6	525	67
Ideal Flow (vphpl)	1900	1900	1900	1900	1900	1900	1900	1900	1900	1900	1900	1900
Storage Length (m)	0.0		0.0	0.0		0.0	15.0		0.0	25.0		0.0
Storage Lanes	0		1	0		0	1		0	1		1
Taper Length (m)	7.5			7.5			7.5			7.5		
Lane Util. Factor	1.00	1.00	1.00	1.00	1.00	1.00	1.00	1.00	1.00	1.00	1.00	1.00
Ped Bike Factor		0.98	0.97		0.99		0.99			1.00		0.93
Frt			0.850		0.967							0.850
Flt Protected		0.959			0.993		0.950			0.950		
Satd. Flow (prot)	0	1704	1524	0	1773	0	1787	1792	0	1805	1810	1583
Flt Permitted		0.715			0.937		0.189			0.370		
Satd. Flow (perm)	0	1245	1483	0	1672	0	351	1792	0	701	1810	1477
Right Turn on Red			Yes			Yes			Yes			Yes
Satd. Flow (RTOR)			284		28							113
Link Speed (k/h)		50			50			50				50
Link Distance (m)		147.8			117.2			341.7				188.6
Travel Time (s)		10.6			8.4			24.6				13.6
Confl. Peds. (#/hr)	30		4	4		30	29		6	6		29
Peak Hour Factor	0.55	0.55	0.55	0.64	0.64	0.64	0.85	0.85	0.85	0.86	0.86	0.86
Heavy Vehicles (%)	8%	0%	6%	0%	3%	0%	1%	6%	0%	0%	5%	2%
Adj. Flow (vph)	195	31	371	20	84	34	159	529	0	7	610	78
Shared Lane Traffic (%)												
Lane Group Flow (vph)	0	226	371	0	138	0	159	529	0	7	610	78
Enter Blocked Intersection	No	No	No	No	No	No	No	No	No	No	No	No
Lane Alignment	Left	Left	Right	Left	Left	Right	Left	Left	Right	Left	Left	Right
Median Width(m)		0.0			0.0			3.6				3.6
Link Offset(m)		0.0			0.0			0.0				0.0
Crosswalk Width(m)		4.8			4.8			4.8				4.8
Two way Left Turn Lane												
Headway Factor	1.00	1.00	1.00	1.00	1.00	1.00	1.00	1.00	1.00	1.00	1.00	1.00
Turning Speed (k/h)	25		15	25		15	25		15	25		15
Number of Detectors	1	1	1	1	2		1	2		1	2	1
Detector Template	Left		Right	Left	Thru			Thru			Thru	Right
Leading Detector (m)	2.0	10.0	2.0	2.0	10.0		5.0	10.0		5.0	10.0	2.0
Trailing Detector (m)	0.0	5.0	0.0	0.0	0.0		-1.0	0.0		-1.0	0.0	0.0
Detector 1 Position(m)	0.0	5.0	0.0	0.0	0.0		-1.0	0.0		-1.0	0.0	0.0
Detector 1 Size(m)	2.0	5.0	2.0	2.0	0.6		6.0	0.6		6.0	0.6	2.0
Detector 1 Type	Cl+Ex	Cl+Ex	Cl+Ex	Cl+Ex	Cl+Ex		Cl+Ex	Cl+Ex		Cl+Ex	Cl+Ex	Cl+Ex
Detector 1 Channel												
Detector 1 Extend (s)	0.0	0.0	0.0	0.0	0.0		0.0	0.0		0.0	0.0	0.0
Detector 1 Queue (s)	0.0	0.0	0.0	0.0	0.0		0.0	0.0		0.0	0.0	0.0
Detector 1 Delay (s)	0.0	0.0	0.0	0.0	0.0		0.0	0.0		0.0	0.0	0.0
Detector 2 Position(m)					9.4			9.4				9.4
Detector 2 Size(m)					0.6			0.6				0.6
Detector 2 Type					Cl+Ex			Cl+Ex				Cl+Ex
Detector 2 Channel												
Detector 2 Extend (s)					0.0			0.0				0.0

Perthmore Subdivision TIS  
26: Wilson Street & Sunset Boulevard

2035 Total Traffic Mitigations  
AM Peak Hour



Lane Group	EBL	EBT	EBR	WBL	WBT	WBR	NBL	NBT	NBR	SBL	SBT	SBR
Turn Type	Perm	NA	Perm	Perm	NA		pm+pt	NA		pm+pt	NA	Perm
Protected Phases		4			8		5	2		1	6	
Permitted Phases	4		4	8			2			6		6
Detector Phase	4	4	4	8	8		5	2		1	6	6
Switch Phase							2			6		
Minimum Initial (s)	10.0	10.0	10.0	10.0	10.0		5.0	10.0		5.0	10.0	10.0
Minimum Split (s)	22.6	22.6	22.6	22.6	22.6		9.6	22.6		9.6	22.6	22.6
Total Split (s)	22.6	22.6	22.6	22.6	22.6		9.6	27.8		9.6	27.8	27.8
Total Split (%)	37.7%	37.7%	37.7%	37.7%	37.7%		16.0%	46.3%		16.0%	46.3%	46.3%
Maximum Green (s)	18.0	18.0	18.0	18.0	18.0		5.0	23.2		5.0	23.2	23.2
Yellow Time (s)	3.3	3.3	3.3	3.3	3.3		3.3	3.3		3.3	3.3	3.3
All-Red Time (s)	1.3	1.3	1.3	1.3	1.3		1.3	1.3		1.3	1.3	1.3
Lost Time Adjust (s)		0.0	0.0		0.0		0.0	0.0		0.0	0.0	0.0
Total Lost Time (s)		4.6	4.6		4.6		4.6	4.6		4.6	4.6	4.6
Lead/Lag							Lead	Lag		Lead	Lag	Lag
Lead-Lag Optimize?							Yes	Yes		Yes	Yes	Yes
Vehicle Extension (s)	3.0	3.0	3.0	3.0	3.0		3.0	3.0		3.0	3.0	3.0
Recall Mode	None	None	None	None	None		None	Min		None	Min	Min
Walk Time (s)	7.0	7.0	7.0	7.0	7.0			7.0			7.0	7.0
Flash Dont Walk (s)	11.0	11.0	11.0	11.0	11.0			11.0			11.0	11.0
Pedestrian Calls (#/hr)	6	6	6	22	22			22			4	4
Act Effct Green (s)		14.8	14.8		14.8		27.1	26.2		24.5	20.9	20.9
Actuated g/C Ratio		0.28	0.28		0.28		0.52	0.50		0.47	0.40	0.40
v/c Ratio		0.65	0.60		0.28		0.49	0.59		0.02	0.85	0.12
Control Delay		27.9	9.5		15.2		12.1	14.6		6.3	29.7	2.0
Queue Delay		0.0	0.0		0.0		0.0	0.0		0.0	0.0	0.0
Total Delay		27.9	9.5		15.2		12.1	14.6		6.3	29.7	2.0
LOS		C	A		B		B	B		A	C	A
Approach Delay		16.5			15.2			14.1			26.4	
Approach LOS		B			B			B			C	

Intersection Summary

Area Type:	Other
Cycle Length:	60
Actuated Cycle Length:	52.4
Natural Cycle:	60
Control Type:	Semi Act-Uncoord
Maximum v/c Ratio:	0.85
Intersection Signal Delay:	18.9
Intersection LOS:	B
Intersection Capacity Utilization:	65.0%
ICU Level of Service:	C
Analysis Period (min):	15

Splits and Phases: 26: Wilson Street & Sunset Boulevard

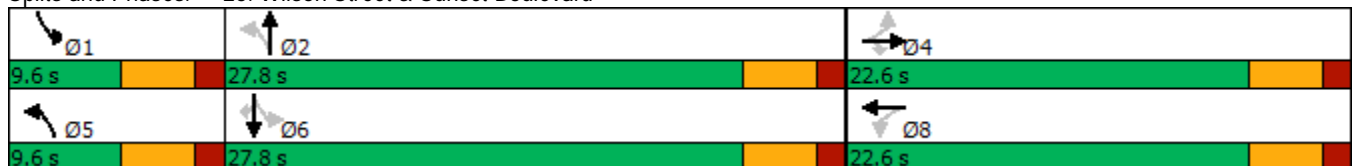

Perthmore Subdivision TIS  
 30: Wilson Street & Leslie Street/Isabella Street

2035 Total Traffic Mitigations  
 AM Peak Hour



Lane Group	EBL	EBT	EBR	WBL	WBT	WBR	NBL	NBT	NBR	SBL	SBT	SBR
Lane Configurations		↕			↕		↗	↘		↗	↘	
Traffic Volume (vph)	30	12	3	20	10	68	0	474	3	49	584	32
Future Volume (vph)	30	12	3	20	10	68	0	474	3	49	584	32
Ideal Flow (vphpl)	1900	1900	1900	1900	1900	1900	1900	1900	1900	1900	1900	1900
Storage Length (m)	0.0		0.0	0.0		0.0	60.0		0.0	25.0		0.0
Storage Lanes	0		0	0		0	1		0	1		0
Taper Length (m)	7.5			7.5			25.0			15.0		
Lane Util. Factor	1.00	1.00	1.00	1.00	1.00	1.00	1.00	1.00	1.00	1.00	1.00	1.00
Ped Bike Factor		0.97			0.94			1.00		0.99	1.00	
Frt		0.991			0.907			0.999			0.992	
Flt Protected		0.968			0.990					0.950		
Satd. Flow (prot)	0	1522	0	0	1542	0	1900	1758	0	1752	1745	0
Flt Permitted		0.785			0.914					0.281		
Satd. Flow (perm)	0	1196	0	0	1420	0	1900	1758	0	514	1745	0
Right Turn on Red			Yes			Yes			Yes			Yes
Satd. Flow (RTOR)		4			94			1			7	
Link Speed (k/h)		50			50			50			50	
Link Distance (m)		91.6			415.9			340.1			341.7	
Travel Time (s)		6.6			29.9			24.5			24.6	
Confl. Peds. (#/hr)	23		4	4		23	6		16	16		6
Peak Hour Factor	0.78	0.78	0.78	0.72	0.72	0.72	0.82	0.82	0.82	0.82	0.82	0.82
Heavy Vehicles (%)	24%	0%	50%	0%	14%	4%	0%	8%	0%	3%	7%	23%
Adj. Flow (vph)	38	15	4	28	14	94	0	578	4	60	712	39
Shared Lane Traffic (%)												
Lane Group Flow (vph)	0	57	0	0	136	0	0	582	0	60	751	0
Enter Blocked Intersection	No	No	No	No	No	No	No	No	No	No	No	No
Lane Alignment	Left	Left	Right	Left	Left	Right	Left	Left	Right	Left	Left	Right
Median Width(m)		0.0			0.0			3.6			3.6	
Link Offset(m)		0.0			0.0			0.0			0.0	
Crosswalk Width(m)		4.8			4.8			4.8			4.8	
Two way Left Turn Lane												
Headway Factor	1.00	1.00	1.00	1.00	1.00	1.00	1.00	1.00	1.00	1.00	1.00	1.00
Turning Speed (k/h)	25		15	25		15	25		15	25		15
Number of Detectors	1	2		1	2		1	2		1	2	
Detector Template	Left	Thru		Left	Thru		Left	Thru		Left	Thru	
Leading Detector (m)	2.0	10.0		2.0	10.0		2.0	10.0		2.0	10.0	
Trailing Detector (m)	0.0	0.0		0.0	0.0		0.0	0.0		0.0	0.0	
Detector 1 Position(m)	0.0	0.0		0.0	0.0		0.0	0.0		0.0	0.0	
Detector 1 Size(m)	2.0	0.6		2.0	0.6		2.0	0.6		2.0	0.6	
Detector 1 Type	Cl+Ex	Cl+Ex		Cl+Ex	Cl+Ex		Cl+Ex	Cl+Ex		Cl+Ex	Cl+Ex	
Detector 1 Channel												
Detector 1 Extend (s)	0.0	0.0		0.0	0.0		0.0	0.0		0.0	0.0	
Detector 1 Queue (s)	0.0	0.0		0.0	0.0		0.0	0.0		0.0	0.0	
Detector 1 Delay (s)	0.0	0.0		0.0	0.0		0.0	0.0		0.0	0.0	
Detector 2 Position(m)		9.4			9.4			9.4			9.4	
Detector 2 Size(m)		0.6			0.6			0.6			0.6	
Detector 2 Type		Cl+Ex			Cl+Ex			Cl+Ex			Cl+Ex	
Detector 2 Channel												
Detector 2 Extend (s)		0.0			0.0			0.0			0.0	

Perthmore Subdivision TIS  
 30: Wilson Street & Leslie Street/Isabella Street

2035 Total Traffic Mitigations  
 AM Peak Hour



Lane Group	EBL	EBT	EBR	WBL	WBT	WBR	NBL	NBT	NBR	SBL	SBT	SBR
Turn Type	Perm	NA		Perm	NA		pm+pt	NA		pm+pt	NA	
Protected Phases		4			8		5	2		1	6	
Permitted Phases	4			8			2			6		
Detector Phase	4	4		8	8		5	2		1	6	
Switch Phase							2			6		
Minimum Initial (s)	10.0	10.0		10.0	10.0		5.0	10.0		5.0	10.0	
Minimum Split (s)	15.1	15.1		15.1	15.1		9.6	35.0		9.6	35.0	
Total Split (s)	15.1	15.1		15.1	15.1		9.6	35.3		9.6	35.3	
Total Split (%)	25.2%	25.2%		25.2%	25.2%		16.0%	58.8%		16.0%	58.8%	
Maximum Green (s)	10.5	10.5		10.5	10.5		5.0	30.7		5.0	30.7	
Yellow Time (s)	3.3	3.3		3.3	3.3		3.3	3.3		3.3	3.3	
All-Red Time (s)	1.3	1.3		1.3	1.3		1.3	1.3		1.3	1.3	
Lost Time Adjust (s)		0.0			0.0		0.0	0.0		0.0	0.0	
Total Lost Time (s)		4.6			4.6		4.6	4.6		4.6	4.6	
Lead/Lag							Lead	Lag		Lead	Lag	
Lead-Lag Optimize?							Yes	Yes		Yes	Yes	
Vehicle Extension (s)	3.0	3.0		3.0	3.0		3.0	3.0		3.0	3.0	
Recall Mode	None	None		None	None		None	Min		None	Min	
Walk Time (s)	6.0	6.0		6.0	6.0			7.0			7.0	
Flash Dont Walk (s)	4.5	4.5		4.5	4.5			11.0			11.0	
Pedestrian Calls (#/hr)	16	16		6	6			20			4	
Act Effct Green (s)		10.7			10.7			27.8		31.3	32.8	
Actuated g/C Ratio		0.23			0.23			0.59		0.66	0.69	
v/c Ratio		0.21			0.34			0.56		0.12	0.62	
Control Delay		20.8			11.8			12.6		4.2	8.5	
Queue Delay		0.0			0.0			0.0		0.0	0.0	
Total Delay		20.8			11.8			12.6		4.2	8.5	
LOS		C			B			B		A	A	
Approach Delay		20.8			11.8			12.6			8.2	
Approach LOS		C			B			B			A	

Intersection Summary

Area Type: Other  
 Cycle Length: 60  
 Actuated Cycle Length: 47.2  
 Natural Cycle: 60  
 Control Type: Semi Act-Uncoord  
 Maximum v/c Ratio: 0.62  
 Intersection Signal Delay: 10.6  
 Intersection LOS: B  
 Intersection Capacity Utilization 56.9%  
 ICU Level of Service B  
 Analysis Period (min) 15

Splits and Phases: 30: Wilson Street & Leslie Street/Isabella Street

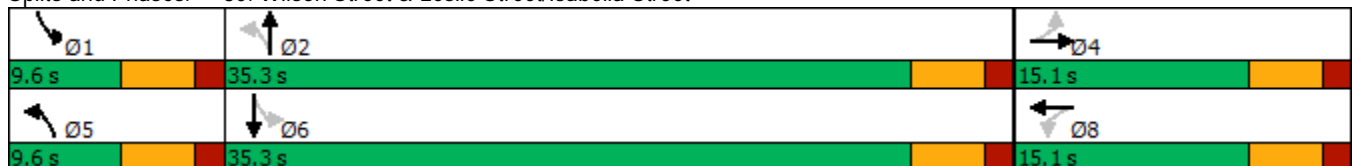

Intersection						
Int Delay, s/veh	2.4					
Movement	EBL	EBT	WBT	WBR	SBL	SBR
Lane Configurations		↕	↑	↗	↘	
Traffic Vol, veh/h	27	144	220	8	19	57
Future Vol, veh/h	27	144	220	8	19	57
Conflicting Peds, #/hr	0	0	0	0	0	0
Sign Control	Free	Free	Free	Free	Stop	Stop
RT Channelized	-	None	-	None	-	None
Storage Length	-	-	-	25	0	-
Veh in Median Storage, #	-	0	0	-	0	-
Grade, %	-	0	0	-	0	-
Peak Hour Factor	83	83	84	84	78	78
Heavy Vehicles, %	50	9	1	25	0	12
Mvmt Flow	33	173	262	10	24	73

Major/Minor	Major1	Major2	Minor2		
Conflicting Flow All	272	0	-	0	501 262
Stage 1	-	-	-	-	262 -
Stage 2	-	-	-	-	239 -
Critical Hdwy	4.6	-	-	-	6.4 6.32
Critical Hdwy Stg 1	-	-	-	-	5.4 -
Critical Hdwy Stg 2	-	-	-	-	5.4 -
Follow-up Hdwy	2.65	-	-	-	3.5 3.408
Pot Cap-1 Maneuver	1059	-	-	-	533 753
Stage 1	-	-	-	-	786 -
Stage 2	-	-	-	-	805 -
Platoon blocked, %		-	-	-	
Mov Cap-1 Maneuver	1059	-	-	-	515 753
Mov Cap-2 Maneuver	-	-	-	-	515 -
Stage 1	-	-	-	-	759 -
Stage 2	-	-	-	-	805 -

Approach	EB	WB	SB
HCM Control Delay, s	1.3	0	11.2
HCM LOS			B

Minor Lane/Major Mvmt	EBL	EBT	WBT	WBR	SBLn1
Capacity (veh/h)	1059	-	-	-	675
HCM Lane V/C Ratio	0.031	-	-	-	0.144
HCM Control Delay (s)	8.5	0	-	-	11.2
HCM Lane LOS	A	A	-	-	B
HCM 95th %tile Q(veh)	0.1	-	-	-	0.5



Intersection						
Int Delay, s/veh	6.2					
Movement	EBT	EBR	WBL	WBT	NBL	NBR
Lane Configurations						
Traffic Vol, veh/h	71	103	23	58	88	21
Future Vol, veh/h	71	103	23	58	88	21
Conflicting Peds, #/hr	0	0	0	0	0	28
Sign Control	Free	Free	Free	Free	Stop	Stop
RT Channelized	-	None	-	None	-	None
Storage Length	-	-	-	-	0	-
Veh in Median Storage, #	0	-	-	0	0	-
Grade, %	0	-	-	0	0	-
Peak Hour Factor	63	63	68	68	41	41
Heavy Vehicles, %	2	25	17	8	3	15
Mvmt Flow	113	163	34	85	215	51

Major/Minor	Major1	Major2	Minor1		
Conflicting Flow All	0	0	276	0	348 223
Stage 1	-	-	-	-	195 -
Stage 2	-	-	-	-	153 -
Critical Hdwy	-	-	4.27	-	6.43 6.35
Critical Hdwy Stg 1	-	-	-	-	5.43 -
Critical Hdwy Stg 2	-	-	-	-	5.43 -
Follow-up Hdwy	-	-	2.353	-	3.527 3.435
Pot Cap-1 Maneuver	-	-	1205	-	647 785
Stage 1	-	-	-	-	836 -
Stage 2	-	-	-	-	873 -
Platoon blocked, %	-	-	-	-	-
Mov Cap-1 Maneuver	-	-	1205	-	628 766
Mov Cap-2 Maneuver	-	-	-	-	628 -
Stage 1	-	-	-	-	836 -
Stage 2	-	-	-	-	847 -

Approach	EB	WB	NB
HCM Control Delay, s	0	2.3	14.3
HCM LOS			B

Minor Lane/Major Mvmt	NBLn1	EBT	EBR	WBL	WBT
Capacity (veh/h)	651	-	-	1205	-
HCM Lane V/C Ratio	0.408	-	-	0.028	-
HCM Control Delay (s)	14.3	-	-	8.1	0
HCM Lane LOS	B	-	-	A	A
HCM 95th %tile Q(veh)	2	-	-	0.1	-

Intersection												
Int Delay, s/veh	4.3											
Movement	EBL	EBT	EBR	WBL	WBT	WBR	NBL	NBT	NBR	SBL	SBT	SBR
Lane Configurations		↕			↕			↕			↕	
Traffic Vol, veh/h	7	6	12	12	4	92	7	410	13	94	498	23
Future Vol, veh/h	7	6	12	12	4	92	7	410	13	94	498	23
Conflicting Peds, #/hr	3	0	3	3	0	3	13	0	10	10	0	13
Sign Control	Stop	Stop	Stop	Stop	Stop	Stop	Free	Free	Free	Free	Free	Free
RT Channelized	-	-	None	-	-	None	-	-	None	-	-	None
Storage Length	-	-	-	-	-	-	-	-	-	-	-	65
Veh in Median Storage, #	-	0	-	-	0	-	-	0	-	-	0	-
Grade, %	-	0	-	-	0	-	-	0	-	-	0	-
Peak Hour Factor	71	71	71	77	77	77	89	89	89	79	79	79
Heavy Vehicles, %	20	0	0	0	0	28	0	6	0	29	2	25
Mvmt Flow	10	8	17	16	5	119	8	461	15	119	630	29

Major/Minor	Minor2		Minor1		Major1			Major2				
Conflicting Flow All	1446	1398	346	1055	1405	482	672	0	0	486	0	0
Stage 1	896	896	-	495	495	-	-	-	-	-	-	-
Stage 2	550	502	-	560	910	-	-	-	-	-	-	-
Critical Hdwy	7.6	6.5	6.9	7.3	6.5	6.62	4.1	-	-	4.535	-	-
Critical Hdwy Stg 1	6.8	5.5	-	6.1	5.5	-	-	-	-	-	-	-
Critical Hdwy Stg 2	6.4	5.5	-	6.5	5.5	-	-	-	-	-	-	-
Follow-up Hdwy	3.69	4	3.3	3.5	4	3.566	2.2	-	-	2.4755	-	-
Pot Cap-1 Maneuver	88	142	656	194	141	523	928	-	-	927	-	-
Stage 1	274	362	-	560	549	-	-	-	-	-	-	-
Stage 2	480	545	-	485	356	-	-	-	-	-	-	-
Platoon blocked, %								-	-	-	-	-
Mov Cap-1 Maneuver	54	109	647	147	109	517	918	-	-	919	-	-
Mov Cap-2 Maneuver	54	109	-	147	109	-	-	-	-	-	-	-
Stage 1	268	285	-	549	538	-	-	-	-	-	-	-
Stage 2	360	534	-	363	280	-	-	-	-	-	-	-

Approach	EB		WB		NB		SB	
HCM Control Delay, s	45.6		20.9		0.1		2	
HCM LOS	E		C					

Minor Lane/Major Mvmt	NBL	NBT	NBR	EBLn1WBLn1	SBL	SBT	SBR
Capacity (veh/h)	918	-	-	123	365	919	-
HCM Lane V/C Ratio	0.009	-	-	0.286	0.384	0.129	-
HCM Control Delay (s)	9	0	-	45.6	20.9	9.5	0.7
HCM Lane LOS	A	A	-	E	C	A	A
HCM 95th %tile Q(veh)	0	-	-	1.1	1.8	0.4	-

Perthmore Subdivision TIS  
7: Drummond Street & North Street

2035 Total Conditions Mitigations  
PM Peak Hour



Lane Group	EBL	EBT	EBR	WBL	WBT	WBR	NBL	NBT	NBR	SBL	SBT	SBR
Lane Configurations		↕			↕			↕			↕	
Traffic Volume (vph)	16	122	18	72	119	158	22	364	68	172	330	16
Future Volume (vph)	16	122	18	72	119	158	22	364	68	172	330	16
Ideal Flow (vphpl)	1900	1900	1900	1900	1900	1900	1900	1900	1900	1900	1900	1900
Lane Util. Factor	1.00	1.00	1.00	1.00	1.00	1.00	1.00	1.00	1.00	1.00	1.00	1.00
Ped Bike Factor		1.00			0.99			1.00			1.00	
Frt		0.985			0.939			0.980			0.996	
Flt Protected		0.995			0.990			0.998			0.984	
Satd. Flow (prot)	0	1773	0	0	1707	0	0	1850	0	0	1860	0
Flt Permitted		0.942			0.899			0.963			0.702	
Satd. Flow (perm)	0	1678	0	0	1548	0	0	1784	0	0	1325	0
Right Turn on Red			Yes			Yes			Yes			Yes
Satd. Flow (RTOR)		11			71			23			4	
Link Speed (k/h)		50			50			50			50	
Link Distance (m)		296.2			748.0			359.5			258.7	
Travel Time (s)		21.3			53.9			25.9			18.6	
Confl. Peds. (#/hr)	5		5	5		5	5		7	7		5
Peak Hour Factor	0.85	0.85	0.85	0.85	0.85	0.85	0.89	0.89	0.89	0.85	0.85	0.85
Heavy Vehicles (%)	0%	6%	0%	0%	5%	1%	0%	0%	0%	0%	0%	0%
Adj. Flow (vph)	19	144	21	85	140	186	25	409	76	202	388	19
Shared Lane Traffic (%)												
Lane Group Flow (vph)	0	184	0	0	411	0	0	510	0	0	609	0
Enter Blocked Intersection	No	No	No	No	No	No	No	No	No	No	No	No
Lane Alignment	Left	Left	Right	Left	Left	Right	Left	Left	Right	Left	Left	Right
Median Width(m)		0.0			0.0			0.0			0.0	
Link Offset(m)		0.0			0.0			0.0			0.0	
Crosswalk Width(m)		4.8			4.8			4.8			4.8	
Two way Left Turn Lane												
Headway Factor	1.00	1.00	1.00	1.00	1.00	1.00	1.00	1.00	1.00	1.00	1.00	1.00
Turning Speed (k/h)	25		15	25		15	25		15	25		15
Number of Detectors	1	2		1	2		1	2		1	2	
Detector Template	Left	Thru		Left	Thru		Left	Thru		Left	Thru	
Leading Detector (m)	2.0	10.0		2.0	10.0		2.0	10.0		2.0	10.0	
Trailing Detector (m)	0.0	0.0		0.0	0.0		0.0	0.0		0.0	0.0	
Detector 1 Position(m)	0.0	0.0		0.0	0.0		0.0	0.0		0.0	0.0	
Detector 1 Size(m)	2.0	0.6		2.0	0.6		2.0	0.6		2.0	0.6	
Detector 1 Type	Cl+Ex	Cl+Ex		Cl+Ex	Cl+Ex		Cl+Ex	Cl+Ex		Cl+Ex	Cl+Ex	
Detector 1 Channel												
Detector 1 Extend (s)	0.0	0.0		0.0	0.0		0.0	0.0		0.0	0.0	
Detector 1 Queue (s)	0.0	0.0		0.0	0.0		0.0	0.0		0.0	0.0	
Detector 1 Delay (s)	0.0	0.0		0.0	0.0		0.0	0.0		0.0	0.0	
Detector 2 Position(m)		9.4			9.4			9.4			9.4	
Detector 2 Size(m)		0.6			0.6			0.6			0.6	
Detector 2 Type		Cl+Ex			Cl+Ex			Cl+Ex			Cl+Ex	
Detector 2 Channel												
Detector 2 Extend (s)		0.0			0.0			0.0			0.0	
Turn Type	Perm	NA		Perm	NA		Perm	NA		Perm	NA	
Protected Phases		4			8			2			6	
Permitted Phases	4			8			2			6		

Perthmore Subdivision TIS  
7: Drummond Street & North Street

2035 Total Conditions Mitigations  
PM Peak Hour



Lane Group	EBL	EBT	EBR	WBL	WBT	WBR	NBL	NBT	NBR	SBL	SBT	SBR
Detector Phase	4	4		8	8		2	2		6	6	
Switch Phase												
Minimum Initial (s)	10.0	10.0		10.0	10.0		10.0	10.0		10.0	10.0	
Minimum Split (s)	22.6	22.6		22.6	22.6		22.6	22.6		22.6	22.6	
Total Split (s)	22.6	22.6		22.6	22.6		37.4	37.4		37.4	37.4	
Total Split (%)	37.7%	37.7%		37.7%	37.7%		62.3%	62.3%		62.3%	62.3%	
Maximum Green (s)	18.0	18.0		18.0	18.0		32.8	32.8		32.8	32.8	
Yellow Time (s)	3.3	3.3		3.3	3.3		3.3	3.3		3.3	3.3	
All-Red Time (s)	1.3	1.3		1.3	1.3		1.3	1.3		1.3	1.3	
Lost Time Adjust (s)		0.0			0.0			0.0			0.0	
Total Lost Time (s)		4.6			4.6			4.6			4.6	
Lead/Lag												
Lead-Lag Optimize?												
Vehicle Extension (s)	3.0	3.0		3.0	3.0		3.0	3.0		3.0	3.0	
Recall Mode	None	None		None	None		Max	Max		Max	Max	
Walk Time (s)	7.0	7.0		7.0	7.0		7.0	7.0		7.0	7.0	
Flash Dont Walk (s)	11.0	11.0		11.0	11.0		11.0	11.0		11.0	11.0	
Pedestrian Calls (#/hr)	0	0		0	0		0	0		0	0	
Act Effect Green (s)		16.1			16.1			32.9			32.9	
Actuated g/C Ratio		0.28			0.28			0.57			0.57	
v/c Ratio		0.39			0.86			0.50			0.81	
Control Delay		18.5			35.9			9.9			22.5	
Queue Delay		0.0			0.0			0.0			0.0	
Total Delay		18.5			35.9			9.9			22.5	
LOS		B			D			A			C	
Approach Delay		18.5			35.9			9.9			22.5	
Approach LOS		B			D			A			C	
Queue Length 50th (m)		15.4			35.8			31.7			52.8	
Queue Length 95th (m)		28.4			#71.6			53.3			#105.4	
Internal Link Dist (m)		272.2			724.0			335.5			234.7	
Turn Bay Length (m)												
Base Capacity (vph)		527			528			1017			750	
Starvation Cap Reductn		0			0			0			0	
Spillback Cap Reductn		0			0			0			0	
Storage Cap Reductn		0			0			0			0	
Reduced v/c Ratio		0.35			0.78			0.50			0.81	

Intersection Summary

Area Type:	Other
Cycle Length:	60
Actuated Cycle Length:	58.2
Natural Cycle:	60
Control Type:	Semi Act-Uncoord
Maximum v/c Ratio:	0.86
Intersection Signal Delay:	21.6
Intersection LOS:	C
Intersection Capacity Utilization:	97.4%
ICU Level of Service:	F
Analysis Period (min):	15
# 95th percentile volume exceeds capacity, queue may be longer. Queue shown is maximum after two cycles.	

Splits and Phases: 7: Drummond Street & North Street



Perthmore Subdivision TIS  
 12: Wilson Street /Canadian tire Ent/Ext & HWY 7

2035 Total Conditions Mitigations  
 PM Peak Hour



Lane Group	EBL	EBT	EBR	WBL	WBT	WBR	NBL	NBT	NBR	SBL	SBT	SBR
Lane Configurations												
Traffic Volume (vph)	62	834	147	135	770	10	227	32	216	70	29	116
Future Volume (vph)	62	834	147	135	770	10	227	32	216	70	29	116
Ideal Flow (vphpl)	1900	1900	1900	1900	1900	1900	1900	1900	1900	1900	1900	1900
Storage Length (m)	50.0		75.0	45.0		30.0	0.0		0.0	0.0		7.5
Storage Lanes	1		1	1		1	0		1	0		1
Taper Length (m)	7.5			7.5			7.5			10.0		
Lane Util. Factor	1.00	0.95	1.00	1.00	0.95	1.00	1.00	1.00	1.00	1.00	1.00	1.00
Ped Bike Factor								1.00				0.99
Frt			0.850			0.850			0.850			0.850
Flt Protected	0.950			0.950			0.958				0.966	
Satd. Flow (prot)	1805	3471	1553	1752	3438	1615	0	1759	1509	0	1835	1615
Flt Permitted	0.319			0.151			0.627				0.581	
Satd. Flow (perm)	606	3471	1553	279	3438	1615	0	1149	1509	0	1104	1591
Right Turn on Red			Yes			Yes			Yes			Yes
Satd. Flow (RTOR)			179			59			195			107
Link Speed (k/h)		60			60			50				50
Link Distance (m)		455.2			323.0			477.1				562.7
Travel Time (s)		27.3			19.4			34.4				40.5
Confl. Peds. (#/hr)							3					3
Peak Hour Factor	0.82	0.82	0.82	0.87	0.87	0.87	0.70	0.70	0.70	0.93	0.93	0.93
Heavy Vehicles (%)	0%	4%	4%	3%	5%	0%	4%	0%	7%	0%	0%	0%
Adj. Flow (vph)	76	1017	179	155	885	11	324	46	309	75	31	125
Shared Lane Traffic (%)												
Lane Group Flow (vph)	76	1017	179	155	885	11	0	370	309	0	106	125
Enter Blocked Intersection	No	No	No	No	No	No	No	No	No	No	No	No
Lane Alignment	Left	Left	Right	Left	Left	Right	Left	Left	Right	Left	Left	Right
Median Width(m)		3.6			3.6			0.0				0.0
Link Offset(m)		0.0			0.0			0.0				0.0
Crosswalk Width(m)		4.8			4.8			4.8				4.8
Two way Left Turn Lane												
Headway Factor	1.00	1.00	1.00	1.00	1.00	1.00	1.00	1.00	1.00	1.00	1.00	1.00
Turning Speed (k/h)	25		15	25		15	25		15	25		15
Number of Detectors	1	2	1	1	2	1	1	1	1	1	1	1
Detector Template	Left		Right	Left		Right	Left			Left		
Leading Detector (m)	2.0	98.8	2.0	2.0	91.8	2.0	2.0	9.0	9.0	2.0	9.0	9.0
Trailing Detector (m)	0.0	-3.0	0.0	0.0	-3.0	0.0	0.0	-3.0	-3.0	0.0	-0.2	-3.0
Detector 1 Position(m)	0.0	-3.0	0.0	0.0	-3.0	0.0	0.0	-3.0	-3.0	0.0	-0.2	-3.0
Detector 1 Size(m)	2.0	12.0	2.0	2.0	12.0	2.0	2.0	12.0	12.0	2.0	9.2	12.0
Detector 1 Type	Cl+Ex	Cl+Ex	Cl+Ex	Cl+Ex	Cl+Ex	Cl+Ex	Cl+Ex	Cl+Ex	Cl+Ex	Cl+Ex	Cl+Ex	Cl+Ex
Detector 1 Channel												
Detector 1 Extend (s)	0.0	0.0	0.0	0.0	0.0	0.0	0.0	0.0	0.0	0.0	0.0	0.0
Detector 1 Queue (s)	0.0	0.0	0.0	0.0	0.0	0.0	0.0	0.0	0.0	0.0	0.0	0.0
Detector 1 Delay (s)	0.0	0.0	0.0	0.0	0.0	0.0	0.0	0.0	0.0	0.0	0.0	0.0
Detector 2 Position(m)		97.0			90.0							
Detector 2 Size(m)		1.8			1.8							
Detector 2 Type		Cl+Ex			Cl+Ex							
Detector 2 Channel												
Detector 2 Extend (s)		0.0			0.0							

Perthmore Subdivision TIS  
12: Wilson Street /Canadian tire Ent/Ext & HWY 7

2035 Total Conditions Mitigations  
PM Peak Hour



Lane Group	EBL	EBT	EBR	WBL	WBT	WBR	NBL	NBT	NBR	SBL	SBT	SBR
Turn Type	Perm	NA	Perm	pm+pt	NA	Perm	pm+pt	NA	Perm	Perm	NA	Perm
Protected Phases		2		1	6		3	8			4	
Permitted Phases	2		2	6		6	8		8	4		4
Detector Phase	2	2	2	1	1 6	6	3	3 8	8	4	4	4
Switch Phase												
Minimum Initial (s)	20.0	20.0	20.0	7.0	20.0	20.0	7.0	10.0	10.0	10.0	10.0	10.0
Minimum Split (s)	43.9	43.9	43.9	9.0	43.9	43.9	9.0	37.4	37.4	37.4	37.4	37.4
Total Split (s)	44.6	44.6	44.6	9.0	53.6	53.6	9.0	46.4	46.4	37.4	37.4	37.4
Total Split (%)	44.6%	44.6%	44.6%	9.0%	53.6%	53.6%	9.0%	46.4%	46.4%	37.4%	37.4%	37.4%
Maximum Green (s)	37.7	37.7	37.7	7.0	46.7	46.7	7.0	40.0	40.0	31.0	31.0	31.0
Yellow Time (s)	5.0	5.0	5.0	2.0	5.0	5.0	2.0	4.1	4.1	4.1	4.1	4.1
All-Red Time (s)	1.9	1.9	1.9	0.0	1.9	1.9	0.0	2.3	2.3	2.3	2.3	2.3
Lost Time Adjust (s)	0.0	0.0	0.0	0.0	0.0	0.0		0.0	0.0		0.0	0.0
Total Lost Time (s)	6.9	6.9	6.9	2.0	6.9	6.9		6.4	6.4		6.4	6.4
Lead/Lag	Lag	Lag	Lag	Lead			Lead			Lag	Lag	Lag
Lead-Lag Optimize?	Yes	Yes	Yes	Yes			Yes			Yes	Yes	Yes
Vehicle Extension (s)	4.5	4.5	4.5	2.0	4.5	4.5	2.0	3.0	3.0	3.0	3.0	3.0
Recall Mode	Min	Min	Min	None	Min	Min	None	None	None	None	None	None
Walk Time (s)	7.0	7.0	7.0		7.0	7.0		7.0	7.0	7.0	7.0	7.0
Flash Dont Walk (s)	30.0	30.0	30.0		30.0	30.0		24.0	24.0	24.0	24.0	24.0
Pedestrian Calls (#/hr)	0	0	0		0	0		3	3	0	0	0
Act Effct Green (s)	37.9	37.9	37.9	51.9	47.0	47.0		33.1	33.1		24.1	24.1
Actuated g/C Ratio	0.41	0.41	0.41	0.56	0.50	0.50		0.35	0.35		0.26	0.26
v/c Ratio	0.31	0.72	0.24	0.58	0.51	0.01		0.87	0.47		0.37	0.26
Control Delay	25.9	28.1	4.2	21.5	18.0	0.0		49.5	10.6		31.7	8.5
Queue Delay	0.0	0.0	0.0	0.0	0.0	0.0		0.0	0.0		0.0	0.0
Total Delay	25.9	28.1	4.2	21.5	18.0	0.0		49.5	10.6		31.7	8.5
LOS	C	C	A	C	B	A		D	B		C	A
Approach Delay		24.6			18.3			31.8			19.1	
Approach LOS		C			B			C			B	
Queue Length 50th (m)	10.2	89.3	0.0	14.8	61.5	0.0		56.2	14.8		16.4	2.6
Queue Length 95th (m)	21.3	104.9	10.0	26.5	80.9	0.0		60.6	18.8		31.5	15.7
Internal Link Dist (m)		431.2			299.0			453.1			538.7	
Turn Bay Length (m)	50.0		75.0	45.0		30.0						7.5
Base Capacity (vph)	245	1408	736	266	1727	840		511	760		368	602
Starvation Cap Reductn	0	0	0	0	0	0		0	0		0	0
Spillback Cap Reductn	0	0	0	0	0	0		0	0		0	0
Storage Cap Reductn	0	0	0	0	0	0		0	0		0	0
Reduced v/c Ratio	0.31	0.72	0.24	0.58	0.51	0.01		0.72	0.41		0.29	0.21

Intersection Summary

Area Type:	Other
Cycle Length:	100
Actuated Cycle Length:	93.5
Natural Cycle:	100
Control Type:	Semi Act-Uncoord
Maximum v/c Ratio:	0.87
Intersection Signal Delay:	23.7
Intersection Capacity Utilization	75.7%
Intersection LOS:	C
ICU Level of Service	D

Analysis Period (min) 15

Splits and Phases: 12: Wilson Street /Canadian tire Ent/Ext & HWY 7

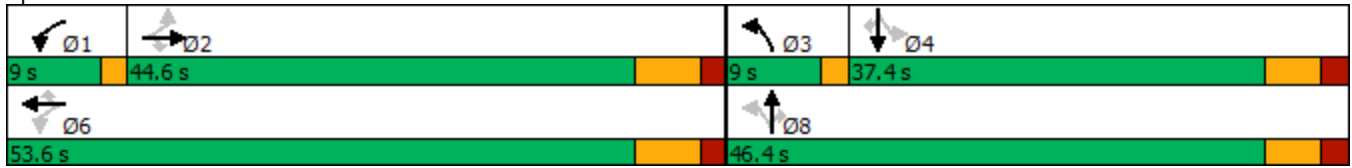



Perthmore Subdivision TIS  
15: Drummond Street/Dufferin Street & HWY 7

2035 Total Conditions Mitigations  
PM Peak Hour



Lane Group	EBL	EBT	EBR	WBL	WBT	WBR	NBL	NBT	NBR	SBL	SBT	SBR
Lane Configurations												
Traffic Volume (vph)	78	610	394	160	560	6	293	23	142	16	28	78
Future Volume (vph)	78	610	394	160	560	6	293	23	142	16	28	78
Ideal Flow (vphpl)	1900	1900	1900	1900	1900	1900	1900	1900	1900	1900	1900	1900
Storage Length (m)	30.0		45.0	30.0		15.0	65.0		0.0	40.0		0.0
Storage Lanes	1		1	1		0	1		0	1		0
Taper Length (m)	7.5			7.5			0.0			20.0		
Lane Util. Factor	1.00	0.95	1.00	0.91	0.91	0.95	1.00	1.00	1.00	1.00	1.00	1.00
Ped Bike Factor							1.00	0.99		1.00	0.99	
Frt			0.850		0.999			0.871				0.889
Flt Protected	0.950			0.950	0.999		0.950			0.950		
Satd. Flow (prot)	1770	3374	1615	1643	3293	0	1787	1606	0	1805	1648	0
Flt Permitted	0.406			0.239	0.935		0.453			0.640		
Satd. Flow (perm)	756	3374	1615	413	3082	0	851	1606	0	1213	1648	0
Right Turn on Red			Yes			Yes			Yes			Yes
Satd. Flow (RTOR)			446		1			161			101	
Link Speed (k/h)		60			60			50			50	
Link Distance (m)		323.0			143.7			376.3			222.4	
Travel Time (s)		19.4			8.6			27.1			16.0	
Confl. Peds. (#/hr)							2		3	3		2
Peak Hour Factor	0.81	0.81	0.81	0.94	0.94	0.94	0.88	0.88	0.88	0.77	0.77	0.77
Heavy Vehicles (%)	2%	7%	0%	0%	5%	0%	1%	0%	2%	0%	0%	2%
Adj. Flow (vph)	96	753	486	170	596	6	333	26	161	21	36	101
Shared Lane Traffic (%)				10%								
Lane Group Flow (vph)	96	753	486	153	619	0	333	187	0	21	137	0
Enter Blocked Intersection	No	No	No	No	No	No	No	No	No	No	No	No
Lane Alignment	Left	Left	Right	Left	Left	Right	Left	Left	Right	Left	Left	Right
Median Width(m)		3.6			3.6			3.6			3.6	
Link Offset(m)		0.0			0.0			0.0			0.0	
Crosswalk Width(m)		4.8			4.8			4.8			4.8	
Two way Left Turn Lane												
Headway Factor	1.00	1.00	1.00	1.00	1.00	1.00	1.00	1.00	1.00	1.00	1.00	1.00
Turning Speed (k/h)	25		15	25		15	25		15	25		15
Number of Detectors	1	1	1	1	2		1	1		1	1	
Detector Template	Left		Right	Left								
Leading Detector (m)	2.0	94.8	2.0	2.0	86.8		9.0	9.0		9.0	9.0	
Trailing Detector (m)	0.0	93.0	0.0	0.0	-1.0		-3.0	-3.0		-3.0	-3.0	
Detector 1 Position(m)	0.0	93.0	0.0	0.0	-1.0		-3.0	-3.0		-3.0	-3.0	
Detector 1 Size(m)	2.0	1.8	2.0	2.0	12.0		12.0	12.0		12.0	12.0	
Detector 1 Type	Cl+Ex	Cl+Ex	Cl+Ex	Cl+Ex	Cl+Ex		Cl+Ex	Cl+Ex		Cl+Ex	Cl+Ex	
Detector 1 Channel												
Detector 1 Extend (s)	0.0	0.0	0.0	0.0	0.0		0.0	0.0		0.0	0.0	
Detector 1 Queue (s)	0.0	0.0	0.0	0.0	0.0		0.0	0.0		0.0	0.0	
Detector 1 Delay (s)	0.0	0.0	0.0	0.0	0.0		0.0	0.0		0.0	0.0	
Detector 2 Position(m)					85.0							
Detector 2 Size(m)					1.8							
Detector 2 Type					Cl+Ex							
Detector 2 Channel												
Detector 2 Extend (s)					0.0							

Perthmore Subdivision TIS  
15: Drummond Street/Dufferin Street & HWY 7

2035 Total Conditions Mitigations  
PM Peak Hour



Lane Group	EBL	EBT	EBR	WBL	WBT	WBR	NBL	NBT	NBR	SBL	SBT	SBR
Turn Type	Perm	NA	Perm	pm+pt	NA		pm+pt	NA		Perm	NA	
Protected Phases		2		1	6		3	8				4
Permitted Phases	2		2	6			8			4		
Detector Phase	2	2	2	1	6		3	8		4		4
Switch Phase												
Minimum Initial (s)	20.0	20.0	20.0	7.0	20.0		5.0	10.0		10.0		10.0
Minimum Split (s)	33.3	33.3	33.3	10.0	36.3		9.5	38.3		38.3		38.3
Total Split (s)	35.7	35.7	35.7	10.0	45.7		11.0	49.3		38.3		38.3
Total Split (%)	37.6%	37.6%	37.6%	10.5%	48.1%		11.6%	51.9%		40.3%		40.3%
Maximum Green (s)	29.4	29.4	29.4	7.0	39.4		6.5	43.0		32.0		32.0
Yellow Time (s)	5.0	5.0	5.0	3.0	5.0		3.5	4.1		4.1		4.1
All-Red Time (s)	1.3	1.3	1.3	0.0	1.3		1.0	2.2		2.2		2.2
Lost Time Adjust (s)	0.0	0.0	0.0	0.0	0.0		0.0	0.0		0.0		0.0
Total Lost Time (s)	6.3	6.3	6.3	3.0	6.3		4.5	6.3		6.3		6.3
Lead/Lag	Lag	Lag	Lag	Lead			Lead			Lag		Lag
Lead-Lag Optimize?	Yes	Yes	Yes	Yes			Yes			Yes		Yes
Vehicle Extension (s)	4.6	4.6	4.6	3.0	4.6		3.0	3.0		3.0		3.0
Recall Mode	Min	Min	Min	None	Min		None	None		None		None
Walk Time (s)	7.0	7.0	7.0		7.0			7.0		7.0		7.0
Flash Dont Walk (s)	20.0	20.0	20.0		20.0			25.0		25.0		25.0
Pedestrian Calls (#/hr)	0	0	0		0			2		0		0
Act Effct Green (s)	23.8	23.8	23.8	37.4	34.0		22.3	20.4		12.0		12.0
Actuated g/C Ratio	0.35	0.35	0.35	0.56	0.51		0.33	0.30		0.18		0.18
v/c Ratio	0.36	0.63	0.57	0.42	0.39		0.85	0.31		0.10		0.36
Control Delay	22.7	21.8	5.8	12.7	12.1		42.5	6.2		26.1		12.6
Queue Delay	0.0	0.0	0.0	0.0	0.0		0.0	0.0		0.0		0.0
Total Delay	22.7	21.8	5.8	12.7	12.1		42.5	6.2		26.1		12.6
LOS	C	C	A	B	B		D	A		C		B
Approach Delay		16.1			12.2			29.4				14.4
Approach LOS		B			B			C				B
Queue Length 50th (m)	9.2	42.6	3.4	10.0	25.7		34.1	2.3		2.4		4.1
Queue Length 95th (m)	22.6	64.5	16.6	26.3	49.6		#73.3	14.8		7.2		13.8
Internal Link Dist (m)		299.0			119.7			352.3				198.4
Turn Bay Length (m)	30.0		45.0	30.0			65.0			40.0		
Base Capacity (vph)	337	1507	968	360	1857		392	1104		589		853
Starvation Cap Reductn	0	0	0	0	0		0	0		0		0
Spillback Cap Reductn	0	0	0	0	0		0	0		0		0
Storage Cap Reductn	0	0	0	0	0		0	0		0		0
Reduced v/c Ratio	0.28	0.50	0.50	0.42	0.33		0.85	0.17		0.04		0.16

Intersection Summary

Area Type:	Other
Cycle Length:	95
Actuated Cycle Length:	67.3
Natural Cycle:	95
Control Type:	Semi Act-Uncoord
Maximum v/c Ratio:	0.85
Intersection Signal Delay:	17.4
Intersection Capacity Utilization	72.5%
Intersection LOS:	B
ICU Level of Service	C

Analysis Period (min) 15

# 95th percentile volume exceeds capacity, queue may be longer.

Queue shown is maximum after two cycles.

Splits and Phases: 15: Drummond Street/Dufferin Street & HWY 7

↙ Ø1	→ Ø2	↖ Ø3	↓ Ø4
10 s	35.7 s	11 s	38.3 s
← Ø6		↗ Ø8	
45.7 s		49.3 s	

Perthmore Subdivision TIS  
26: Wilson Street & Sunset Boulevard

2035 Total Conditions Mitigations  
PM Peak Hour



Lane Group	EBL	EBT	EBR	WBL	WBT	WBR	NBL	NBT	NBR	SBL	SBT	SBR
Lane Configurations												
Traffic Volume (vph)	164	36	277	12	59	36	126	775	6	17	806	78
Future Volume (vph)	164	36	277	12	59	36	126	775	6	17	806	78
Ideal Flow (vphpl)	1900	1900	1900	1900	1900	1900	1900	1900	1900	1900	1900	1900
Storage Length (m)	0.0		0.0	0.0		0.0	15.0		0.0	25.0		0.0
Storage Lanes	0		1	0		0	1		0	1		1
Taper Length (m)	7.5			7.5			7.5			7.5		
Lane Util. Factor	1.00	1.00	1.00	1.00	1.00	1.00	1.00	1.00	1.00	1.00	1.00	1.00
Ped Bike Factor		0.98	0.92		0.98			1.00				0.86
Frt			0.850		0.955			0.999				0.850
Flt Protected		0.961			0.994		0.950			0.950		
Satd. Flow (prot)	0	1728	1583	0	1753	0	1770	1842	0	1805	1863	1615
Flt Permitted		0.618			0.953		0.073			0.153		
Satd. Flow (perm)	0	1085	1458	0	1673	0	136	1842	0	291	1863	1397
Right Turn on Red			Yes			Yes			Yes			Yes
Satd. Flow (RTOR)			172		26			1				90
Link Speed (k/h)		50			50			50				50
Link Distance (m)		238.8			244.8			341.7				185.6
Travel Time (s)		17.2			17.6			24.6				13.4
Confl. Peds. (#/hr)	26		23	23		26	45		20	20		45
Peak Hour Factor	0.93	0.93	0.93	0.77	0.77	0.77	0.87	0.87	0.87	0.83	0.83	0.83
Heavy Vehicles (%)	6%	4%	2%	0%	2%	0%	2%	3%	0%	0%	2%	0%
Adj. Flow (vph)	176	39	298	16	77	47	145	891	7	20	971	94
Shared Lane Traffic (%)												
Lane Group Flow (vph)	0	215	298	0	140	0	145	898	0	20	971	94
Enter Blocked Intersection	No	No	No	No	No	No	No	No	No	No	No	No
Lane Alignment	Left	Left	Right	Left	Left	Right	Left	Left	Right	Left	Left	Right
Median Width(m)		0.0			0.0			3.6				3.6
Link Offset(m)		0.0			0.0			0.0				0.0
Crosswalk Width(m)		4.8			4.8			4.8				4.8
Two way Left Turn Lane												
Headway Factor	1.00	1.00	1.00	1.00	1.00	1.00	1.00	1.00	1.00	1.00	1.00	1.00
Turning Speed (k/h)	25		15	25		15	25		15	25		15
Number of Detectors	1	2	1	1	2		1	2		1	2	1
Detector Template	Left		Right	Left	Thru			Thru			Thru	Right
Leading Detector (m)	2.0	10.0	2.0	2.0	10.0		3.0	10.0		3.0	10.0	2.0
Trailing Detector (m)	0.0	5.0	0.0	0.0	0.0		-1.0	0.0		-1.0	0.0	0.0
Detector 1 Position(m)	0.0	5.0	0.0	0.0	0.0		-1.0	0.0		-1.0	0.0	0.0
Detector 1 Size(m)	2.0	5.0	2.0	2.0	0.6		4.0	0.6		4.0	0.6	2.0
Detector 1 Type	Cl+Ex	Cl+Ex	Cl+Ex	Cl+Ex	Cl+Ex		Cl+Ex	Cl+Ex		Cl+Ex	Cl+Ex	Cl+Ex
Detector 1 Channel												
Detector 1 Extend (s)	0.0	0.0	0.0	0.0	0.0		0.0	0.0		0.0	0.0	0.0
Detector 1 Queue (s)	0.0	0.0	0.0	0.0	0.0		0.0	0.0		0.0	0.0	0.0
Detector 1 Delay (s)	0.0	0.0	0.0	0.0	0.0		0.0	0.0		0.0	0.0	0.0
Detector 2 Position(m)		9.4			9.4			9.4				9.4
Detector 2 Size(m)		0.6			0.6			0.6				0.6
Detector 2 Type		Cl+Ex			Cl+Ex			Cl+Ex				Cl+Ex
Detector 2 Channel												
Detector 2 Extend (s)		0.0			0.0			0.0				0.0

Perthmore Subdivision TIS  
26: Wilson Street & Sunset Boulevard

2035 Total Conditions Mitigations  
PM Peak Hour



Lane Group	EBL	EBT	EBR	WBL	WBT	WBR	NBL	NBT	NBR	SBL	SBT	SBR
Turn Type	Perm	NA	Perm	Perm	NA		pm+pt	NA		pm+pt	NA	Perm
Protected Phases		4			8		5	2		1	6	
Permitted Phases	4		4	8			2			6		6
Detector Phase	4	4	4	8	8		5	2		1	6	6
Switch Phase							2			6		
Minimum Initial (s)	10.0	10.0	10.0	10.0	10.0		5.0	10.0		5.0	10.0	10.0
Minimum Split (s)	22.6	22.6	22.6	22.6	22.6		9.6	22.6		9.6	22.6	22.6
Total Split (s)	28.0	28.0	28.0	28.0	28.0		10.0	56.4		9.6	56.0	56.0
Total Split (%)	29.8%	29.8%	29.8%	29.8%	29.8%		10.6%	60.0%		10.2%	59.6%	59.6%
Maximum Green (s)	23.4	23.4	23.4	23.4	23.4		5.4	51.8		5.0	51.4	51.4
Yellow Time (s)	3.3	3.3	3.3	3.3	3.3		3.3	3.3		3.3	3.3	3.3
All-Red Time (s)	1.3	1.3	1.3	1.3	1.3		1.3	1.3		1.3	1.3	1.3
Lost Time Adjust (s)		0.0	0.0		0.0		0.0	0.0		0.0	0.0	0.0
Total Lost Time (s)		4.6	4.6		4.6		4.6	4.6		4.6	4.6	4.6
Lead/Lag							Lead	Lag		Lead	Lag	Lag
Lead-Lag Optimize?							Yes	Yes		Yes	Yes	Yes
Vehicle Extension (s)	3.0	3.0	3.0	3.0	3.0		3.0	3.0		3.0	3.0	3.0
Recall Mode	None	None	None	None	None		None	Min		None	Min	Min
Walk Time (s)	7.0	7.0	7.0	7.0	7.0			7.0			7.0	7.0
Flash Dont Walk (s)	11.0	11.0	11.0	11.0	11.0			11.0			11.0	11.0
Pedestrian Calls (#/hr)	16	16	16	35	35			20			20	20
Act Effct Green (s)		20.4	20.4		20.4		57.1	55.1		53.7	48.6	48.6
Actuated g/C Ratio		0.23	0.23		0.23		0.65	0.62		0.61	0.55	0.55
v/c Ratio		0.86	0.64		0.35		0.77	0.78		0.08	0.95	0.12
Control Delay		65.2	20.2		26.1		43.4	20.8		6.5	38.9	3.0
Queue Delay		0.0	0.0		0.0		0.0	0.0		0.0	0.0	0.0
Total Delay		65.2	20.2		26.1		43.4	20.8		6.5	38.9	3.0
LOS		E	C		C		D	C		A	D	A
Approach Delay		39.0			26.1			23.9			35.2	
Approach LOS		D			C			C			D	
Queue Length 50th (m)		38.5	19.9		17.6		10.6	103.6		1.2	165.2	0.3
Queue Length 95th (m)		#77.2	48.5		28.0		#42.7	#216.0		3.4	#224.0	6.0
Internal Link Dist (m)		214.8			220.8			317.7			161.6	
Turn Bay Length (m)							15.0			25.0		
Base Capacity (vph)		291	517		467		189	1170		263	1097	859
Starvation Cap Reductn		0	0		0		0	0		0	0	0
Spillback Cap Reductn		0	0		0		0	0		0	0	0
Storage Cap Reductn		0	0		0		0	0		0	0	0
Reduced v/c Ratio		0.74	0.58		0.30		0.77	0.77		0.08	0.89	0.11

Intersection Summary	
Area Type:	Other
Cycle Length:	94
Actuated Cycle Length:	88.4
Natural Cycle:	90
Control Type:	Semi Act-Uncoord
Maximum v/c Ratio:	0.95
Intersection Signal Delay:	31.2
Intersection Capacity Utilization	85.4%
Intersection LOS:	C
ICU Level of Service	E

Analysis Period (min) 15

# 95th percentile volume exceeds capacity, queue may be longer.

Queue shown is maximum after two cycles.

Splits and Phases: 26: Wilson Street & Sunset Boulevard



Perthmore Subdivision TIS  
30: Wilson Street & Leslie Street/Isabella Street

2035 Total Conditions Mitigations  
PM Peak Hour



Lane Group	EBL	EBT	EBR	WBL	WBT	WBR	NBL	NBT	NBR	SBL	SBT	SBR
Lane Configurations		↕			↕		↗	↘		↗	↘	
Traffic Volume (vph)	146	30	7	38	35	92	3	724	4	49	838	58
Future Volume (vph)	146	30	7	38	35	92	3	724	4	49	838	58
Ideal Flow (vphpl)	1900	1900	1900	1900	1900	1900	1900	1900	1900	1900	1900	1900
Storage Length (m)	0.0		0.0	0.0		0.0	60.0		0.0	25.0		0.0
Storage Lanes	0		0	0		0	1		0	1		0
Taper Length (m)	7.5			7.5			25.0			15.0		
Lane Util. Factor	1.00	1.00	1.00	1.00	1.00	1.00	1.00	1.00	1.00	1.00	1.00	1.00
Ped Bike Factor		0.99			0.98			1.00			0.99	
Frt		0.995			0.925			0.999			0.990	
Flt Protected		0.962			0.989		0.950			0.950		
Satd. Flow (prot)	0	1769	0	0	1696	0	1805	1843	0	1703	1811	0
Flt Permitted		0.556			0.904		0.069			0.214		
Satd. Flow (perm)	0	1015	0	0	1550	0	131	1843	0	384	1811	0
Right Turn on Red			Yes			Yes			Yes			Yes
Satd. Flow (RTOR)		2			52							5
Link Speed (k/h)		50			50			50				50
Link Distance (m)		224.9			415.9			340.1				341.7
Travel Time (s)		16.2			29.9			24.5				24.6
Confl. Peds. (#/hr)	4		14	14		4	41		10	10		41
Peak Hour Factor	0.76	0.76	0.76	0.90	0.90	0.90	0.96	0.96	0.96	0.85	0.85	0.85
Heavy Vehicles (%)	3%	0%	0%	0%	0%	0%	0%	3%	0%	6%	3%	0%
Adj. Flow (vph)	192	39	9	42	39	102	3	754	4	58	986	68
Shared Lane Traffic (%)												
Lane Group Flow (vph)	0	240	0	0	183	0	3	758	0	58	1054	0
Enter Blocked Intersection	No	No	No	No	No	No	No	No	No	No	No	No
Lane Alignment	Left	Left	Right	Left	Left	Right	Left	Left	Right	Left	Left	Right
Median Width(m)		0.0			0.0			3.6			3.6	
Link Offset(m)		0.0			0.0			0.0			0.0	
Crosswalk Width(m)		4.8			4.8			4.8			4.8	
Two way Left Turn Lane												
Headway Factor	1.00	1.00	1.00	1.00	1.00	1.00	1.00	1.00	1.00	1.00	1.00	1.00
Turning Speed (k/h)	25		15	25		15	25		15	25		15
Number of Detectors	1	2		1	2		1	2		1	2	
Detector Template	Left	Thru		Left	Thru		Left	Thru		Left	Thru	
Leading Detector (m)	2.0	10.0		2.0	10.0		2.0	10.0		2.0	10.0	
Trailing Detector (m)	0.0	0.0		0.0	0.0		0.0	0.0		0.0	0.0	
Detector 1 Position(m)	0.0	0.0		0.0	0.0		0.0	0.0		0.0	0.0	
Detector 1 Size(m)	2.0	0.6		2.0	0.6		2.0	0.6		2.0	0.6	
Detector 1 Type	Cl+Ex	Cl+Ex		Cl+Ex	Cl+Ex		Cl+Ex	Cl+Ex		Cl+Ex	Cl+Ex	
Detector 1 Channel												
Detector 1 Extend (s)	0.0	0.0		0.0	0.0		0.0	0.0		0.0	0.0	
Detector 1 Queue (s)	0.0	0.0		0.0	0.0		0.0	0.0		0.0	0.0	
Detector 1 Delay (s)	0.0	0.0		0.0	0.0		0.0	0.0		0.0	0.0	
Detector 2 Position(m)		9.4			9.4			9.4			9.4	
Detector 2 Size(m)		0.6			0.6			0.6			0.6	
Detector 2 Type		Cl+Ex			Cl+Ex			Cl+Ex			Cl+Ex	
Detector 2 Channel												
Detector 2 Extend (s)		0.0			0.0			0.0			0.0	

Perthmore Subdivision TIS  
30: Wilson Street & Leslie Street/Isabella Street

2035 Total Conditions Mitigations  
PM Peak Hour



Lane Group	EBL	EBT	EBR	WBL	WBT	WBR	NBL	NBT	NBR	SBL	SBT	SBR
Turn Type	Perm	NA		Perm	NA		pm+pt	NA		pm+pt	NA	
Protected Phases		4			8		5	2		1	6	
Permitted Phases	4			8			2			6		
Detector Phase	4	4		8	8		5	2		1	6	
Switch Phase							2			6		
Minimum Initial (s)	10.0	10.0		10.0	10.0		5.0	10.0		5.0	10.0	
Minimum Split (s)	15.0	15.0		15.0	15.0		9.6	35.0		9.6	35.0	
Total Split (s)	37.0	37.0		37.0	37.0		9.6	73.2		9.8	73.4	
Total Split (%)	30.8%	30.8%		30.8%	30.8%		8.0%	61.0%		8.2%	61.2%	
Maximum Green (s)	32.4	32.4		32.4	32.4		5.0	68.6		5.2	68.8	
Yellow Time (s)	3.3	3.3		3.3	3.3		3.3	3.3		3.3	3.3	
All-Red Time (s)	1.3	1.3		1.3	1.3		1.3	1.3		1.3	1.3	
Lost Time Adjust (s)		0.0			0.0		0.0	0.0		0.0	0.0	
Total Lost Time (s)		4.6			4.6		4.6	4.6		4.6	4.6	
Lead/Lag							Lead	Lag		Lead	Lag	
Lead-Lag Optimize?							Yes	Yes		Yes	Yes	
Vehicle Extension (s)	3.0	3.0		3.0	3.0		3.0	3.0		3.0	3.0	
Recall Mode	None	None		None	None		None	Max		None	Max	
Walk Time (s)	5.0	5.0		5.0	5.0			7.0			7.0	
Flash Dont Walk (s)	5.0	5.0		5.0	5.0			11.0			11.0	
Pedestrian Calls (#/hr)	10	10		4	4			14			33	
Act Effect Green (s)		29.1			29.1		73.0	69.1		75.8	74.8	
Actuated g/C Ratio		0.25			0.25		0.63	0.60		0.66	0.65	
v/c Ratio		0.93			0.43		0.02	0.68		0.19	0.89	
Control Delay		83.8			28.8		7.7	21.1		8.8	29.6	
Queue Delay		0.0			0.0		0.0	0.0		0.0	0.0	
Total Delay		83.8			28.8		7.7	21.1		8.8	29.6	
LOS		F			C		A	C		A	C	
Approach Delay		83.8			28.8			21.1			28.6	
Approach LOS		F			C			C			C	
Queue Length 50th (m)		56.5			26.1		0.3	130.0		4.8	198.5	
Queue Length 95th (m)		#77.7			48.3		1.4	179.5		9.1	#322.6	
Internal Link Dist (m)		200.9			391.9			316.1			317.7	
Turn Bay Length (m)							60.0			25.0		
Base Capacity (vph)		289			476		156	1107		313	1180	
Starvation Cap Reductn		0			0		0	0		0	0	
Spillback Cap Reductn		0			0		0	0		0	0	
Storage Cap Reductn		0			0		0	0		0	0	
Reduced v/c Ratio		0.83			0.38		0.02	0.68		0.19	0.89	

Intersection Summary

Area Type:	Other
Cycle Length:	120
Actuated Cycle Length:	115
Natural Cycle:	100
Control Type:	Semi Act-Uncoord
Maximum v/c Ratio:	0.93
Intersection Signal Delay:	31.9
Intersection Capacity Utilization	79.3%
Intersection LOS:	C
ICU Level of Service	D



Analysis Period (min) 15

# 95th percentile volume exceeds capacity, queue may be longer.

Queue shown is maximum after two cycles.

Splits and Phases: 30: Wilson Street & Leslie Street/Isabella Street

 Ø1	 Ø2	 Ø4
9.8 s	73.2 s	37 s
 Ø5	 Ø6	 Ø8
9.6 s	73.4 s	37 s

Intersection						
Int Delay, s/veh	2.4					
Movement	EBL	EBT	WBT	WBR	SBL	SBR
Lane Configurations		↕	↑	↗	↘	
Traffic Vol, veh/h	63	269	197	32	12	58
Future Vol, veh/h	63	269	197	32	12	58
Conflicting Peds, #/hr	0	0	0	0	0	0
Sign Control	Free	Free	Free	Free	Stop	Stop
RT Channelized	-	None	-	None	-	None
Storage Length	-	-	-	25	0	-
Veh in Median Storage, #	-	0	0	-	0	-
Grade, %	-	0	0	-	0	-
Peak Hour Factor	85	85	83	83	68	68
Heavy Vehicles, %	20	2	0	0	25	0
Mvmt Flow	74	316	237	39	18	85

Major/Minor	Major1	Major2	Minor2		
Conflicting Flow All	276	0	0	701	237
Stage 1	-	-	-	237	-
Stage 2	-	-	-	464	-
Critical Hdwy	4.3	-	-	6.65	6.2
Critical Hdwy Stg 1	-	-	-	5.65	-
Critical Hdwy Stg 2	-	-	-	5.65	-
Follow-up Hdwy	2.38	-	-	3.725	3.3
Pot Cap-1 Maneuver	1190	-	-	372	807
Stage 1	-	-	-	751	-
Stage 2	-	-	-	587	-
Platoon blocked, %		-	-		
Mov Cap-1 Maneuver	1190	-	-	344	807
Mov Cap-2 Maneuver	-	-	-	344	-
Stage 1	-	-	-	695	-
Stage 2	-	-	-	587	-

Approach	EB	WB	SB
HCM Control Delay, s	1.6	0	11.5
HCM LOS			B

Minor Lane/Major Mvmt	EBL	EBT	WBT	WBR	SBLn1
Capacity (veh/h)	1190	-	-	-	656
HCM Lane V/C Ratio	0.062	-	-	-	0.157
HCM Control Delay (s)	8.2	0	-	-	11.5
HCM Lane LOS	A	A	-	-	B
HCM 95th %tile Q(veh)	0.2	-	-	-	0.6

Intersection						
Int Delay, s/veh	1.9					
Movement	EBT	EBR	WBL	WBT	NBL	NBR
Lane Configurations						
Traffic Vol, veh/h	89	14	24	104	12	20
Future Vol, veh/h	89	14	24	104	12	20
Conflicting Peds, #/hr	0	0	0	0	1	10
Sign Control	Free	Free	Free	Free	Stop	Stop
RT Channelized	-	None	-	None	-	None
Storage Length	-	-	-	-	0	-
Veh in Median Storage, #	0	-	-	0	0	-
Grade, %	0	-	-	0	0	-
Peak Hour Factor	78	78	72	72	75	75
Heavy Vehicles, %	2	0	0	1	0	10
Mvmt Flow	114	18	33	144	16	27

Major/Minor	Major1	Major2	Minor1		
Conflicting Flow All	0	0	132	0	334
Stage 1	-	-	-	-	123
Stage 2	-	-	-	-	211
Critical Hdwy	-	-	4.1	-	6.4
Critical Hdwy Stg 1	-	-	-	-	5.4
Critical Hdwy Stg 2	-	-	-	-	5.4
Follow-up Hdwy	-	-	2.2	-	3.5
Pot Cap-1 Maneuver	-	-	1466	-	665
Stage 1	-	-	-	-	907
Stage 2	-	-	-	-	829
Platoon blocked, %	-	-	-	-	-
Mov Cap-1 Maneuver	-	-	1466	-	648
Mov Cap-2 Maneuver	-	-	-	-	648
Stage 1	-	-	-	-	907
Stage 2	-	-	-	-	808

Approach	EB	WB	NB
HCM Control Delay, s	0	1.4	9.9
HCM LOS			A

Minor Lane/Major Mvmt	NBLn1	EBT	EBR	WBL	WBT
Capacity (veh/h)	779	-	-	1466	-
HCM Lane V/C Ratio	0.055	-	-	0.023	-
HCM Control Delay (s)	9.9	-	-	7.5	0
HCM Lane LOS	A	-	-	A	A
HCM 95th %tile Q(veh)	0.2	-	-	0.1	-

Intersection												
Int Delay, s/veh	16.8											
Movement	EBL	EBT	EBR	WBL	WBT	WBR	NBL	NBT	NBR	SBL	SBT	SBR
Lane Configurations		↕			↕			↕			↕	
Traffic Vol, veh/h	7	6	14	17	12	152	13	559	35	172	658	33
Future Vol, veh/h	7	6	14	17	12	152	13	559	35	172	658	33
Conflicting Peds, #/hr	6	0	10	10	0	6	23	0	22	22	0	23
Sign Control	Stop	Stop	Stop	Stop	Stop	Stop	Free	Free	Free	Free	Free	Free
RT Channelized	-	-	None	-	-	None	-	-	None	-	-	None
Storage Length	-	-	-	-	-	-	-	-	-	-	-	65
Veh in Median Storage, #	-	0	-	-	0	-	-	0	-	-	0	-
Grade, %	-	0	-	-	0	-	-	0	-	-	0	-
Peak Hour Factor	68	68	68	94	94	94	89	89	89	96	96	96
Heavy Vehicles, %	20	0	0	0	0	7	0	1	0	12	1	0
Mvmt Flow	10	9	21	18	13	162	15	628	39	179	685	34

Major/Minor	Minor2		Minor1		Major1			Major2				
Conflicting Flow All	1854	1802	393	1415	1800	676	742	0	0	689	0	0
Stage 1	1083	1083	-	700	700	-	-	-	-	-	-	-
Stage 2	771	719	-	715	1100	-	-	-	-	-	-	-
Critical Hdwy	7.6	6.5	6.9	7.3	6.5	6.305	4.1	-	-	4.28	-	-
Critical Hdwy Stg 1	6.8	5.5	-	6.1	5.5	-	-	-	-	-	-	-
Critical Hdwy Stg 2	6.4	5.5	-	6.5	5.5	-	-	-	-	-	-	-
Follow-up Hdwy	3.69	4	3.3	3.5	4.3	3.665	2.2	-	-	2.314	-	-
Pot Cap-1 Maneuver	44	80	612	107	81	442	874	-	-	849	-	-
Stage 1	209	296	-	433	444	-	-	-	-	-	-	-
Stage 2	358	436	-	392	290	-	-	-	-	-	-	-
Platoon blocked, %								-	-	-	-	-
Mov Cap-1 Maneuver	15	48	595	62	49	432	857	-	-	833	-	-
Mov Cap-2 Maneuver	15	48	-	62	49	-	-	-	-	-	-	-
Stage 1	199	186	-	413	424	-	-	-	-	-	-	-
Stage 2	210	416	-	229	182	-	-	-	-	-	-	-

Approach	EB		WB		NB		SB	
HCM Control Delay, s	248.5		92.1		0.2		3	
HCM LOS	F		F					

Minor Lane/Major Mvmt	NBL	NBT	NBR	EBLn1	WBLn1	SBL	SBT	SBR
Capacity (veh/h)	857	-	-	44	208	833	-	-
HCM Lane V/C Ratio	0.017	-	-	0.902	0.926	0.215	-	-
HCM Control Delay (s)	9.3	0	-	248.5	92.1	10.5	1.2	-
HCM Lane LOS	A	A	-	F	F	B	A	-
HCM 95th %tile Q(veh)	0.1	-	-	3.6	7.6	0.8	-	-