

ENVIRONMENTAL IMPACT STATEMENT



Perthmore Estates Subdivision Phase 6, Perth, ON

Project No.: PP-13-9668

Prepared for:

Perthmore Enterprises Inc.
80 Dufferin Street, P.O. Box 20054
Perth, ON
K7H 3M6

Prepared by:

McIntosh Perry Consulting Engineers Ltd.
115 Walgreen Road, R.R.3
Carp, Ontario
K0A 1L0

McINTOSH PERRY

**ENVIRONMENTAL IMPACT STATEMENT
PERTHMORE ESTATES SUBDIVISION PHASE 6, PERTH, ON**

Prepared for:

Perthmore Enterprises Inc.
80 Dufferin Street, P.O. Box 20054
Perth, ON
K7H 3M6

Prepared by:

McINTOSH PERRY

McIntosh Perry Consulting Engineers Ltd.
115 Walgreen Road, R.R.3
Carp, Ontario
K0A 1L0

**Version 002
August 05, 2022**



Written by: Erik Pohanka, B. Sc.
Biologist
McIntosh Perry Consulting Engineers Ltd.

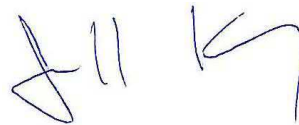

Reviewed by: Jeff King, B. Sc., C. Tech., rcji
Senior Biologist
McIntosh Perry Consulting Engineers Ltd.

TABLE OF CONTENTS

1.0 PROPERTY INFORMATION AND INTRODUCTION 1

2.0 METHODOLOGY 3

3.0 DESCRIPTION OF THE SITE AND THE NATURAL ENVIRONMENT..... 6

 3.1 Existing Land Use 6

 3.2 Natural Heritage System Components..... 6

 3.3 Landforms, Soils and Geology 10

 3.4 Surface Water, Groundwater, Wetlands, and Fish Habitat 10

 3.5 Vegetation Cover..... 10

 3.5.1 Vegetation Community 1: Mixed Meadow (MEM)..... 11

 3.5.2 Vegetation Community 2: Green Ash Organic Deciduous Swamp (SWDO1-2) 11

 3.5.3 Vegetation Community 3: Cattail Organic Shallow Marsh (MASO1-1)..... 11

 3.5.4 Vegetation Community 4: Coniferous Forest (FOC)..... 11

 3.5.5 Vegetation Community 5: Shallow Marsh (MAS) 11

 3.5.6 Vegetation Community 6: Fresh-Moist Lowland Deciduous Forest (FODM7)..... 11

 3.5.7 Vegetation Community 7: Dry-Fresh Sugar Maple-Ironwood Deciduous Forest (FODM5-4) 12

 3.5.8 Vegetation Community 8: Ash Mineral Deciduous Swamp (SWD1)..... 12

 3.5.9 Vegetation Community 9: Willow Organic Deciduous Thicket Swamp (SWTO2)..... 12

 3.5.10 Vegetation Community 10: Cattail Graminoid Organic Meadow Marsh (MAMO1-2) 12

 3.5.11 Vegetation Community 11: Fresh-Moist Poplar Deciduous Forest (FODM8-1) 13

 3.6 Habitat for Species at Risk & Significant Wildlife Habitat..... 18

 3.7 Wildlife 21

4.0 DESCRIPTION OF THE PROPOSED PROJECT..... 27

5.0 IMPACT ASSESSMENT 29

 5.1 Natural Heritage System Components, Landforms, Soils, and Geology 29

 5.2 Surface Water, Groundwater, Wetlands, and Fish Habitat 29

 5.2.1 Wetlands 29

 5.2.2 Fish Habitat 31

 5.3 Vegetation Cover..... 31

 5.3.1 Vegetation Communities 31

5.3.2 SAR Vegetation..... 31

5.4 Habitat for Species at Risk & Significant Wildlife Habitat..... 32

5.5 Wildlife 33

5.6 Significant Woodlands 34

5.7 Wildland Fire Risk Assessment 35

6.0 RECOMMENDED MITIGATION MEASURES 36

6.1 Natural Heritage System Components..... 36

6.2 Surface Water, Groundwater, Wetlands, and Fish Habitat 36

6.3 Vegetation Communities..... 36

6.4 SAR Vegetation..... 36

6.5 Habitat for Species at Risk and Significant Wildlife Habitat 40

6.6 Wildlife 40

7.0 SUMMARY 41

8.0 LIMITATIONS 42

9.0 REFERENCES 43

Tables

Table 1: Summary of Field Investigation Activities 3

Table 2: Vegetation Species observed within the Study Area 15

Table 3: Species at Risk Potentially or Confirmed to be Present within the Study Area 18

Table 4: Wildlife Species Observed within the Study Area 22

Figures

Figure 1: Study Area Key Map..... 2

Figure 2: Natural Heritage Features of the Study Area..... 8

Figure 3: Wetland Reclassification Map of the Study Area 9

Figure 4: Vegetation Communities of the Study Area 14

Figure 5: Proposed Preliminary Site Plan 28

Appendices

Appendix A: Site Photographs

Appendix B: Clean Equipment Protocol

Appendix C: Butternut Health Assessment Report

1.0 PROPERTY INFORMATION AND INTRODUCTION

The property for this Environmental Impact Statement (EIS) is a portion of an existing 29.7 hectare (ha) parcel of land located between Highway 7 (Dufferin Street) and North Street (Drummond Concession 2), north and west of Perthmore Street. The property is legally known as: “PART SOUTHWEST 1/2 AND PART NORTHEAST 1/2 LOT 3 CONCESSION 2 DRUMMOND BEING PART 1, 27R7125 AND PART 1, 27R8420 SAVE AND EXCEPT PLAN 88, 27M3, 27M14, 27M16, 27M21, 27M55 AND PARTS 3 & 4, 27R7540 AND PART 6, 27R11177 TOWN OF PERTH.” The property is located within the Town of Perth, with 300 metres (m) of frontage on the south side of Highway 7 and 380 m of frontage on the north side of North Street (Drummond Concession 2) (**Figure 1**).

The area of the proposed subdivision, hereinafter referred to as the “subject property” measures approximately 5.6 hectares.

Under the *Town of Perth Official Plan – Land Use Designation* (Tunnock Consulting Ltd., 2015), the subject property is designated as Residential Area, except for two very small areas within the proposed Stormwater Management facility (Block 55 on the proposed Draft Plan of Subdivision) which are designated as Environmental Protection Area (Natural Heritage Feature – NHF / Provincially Significant Wetland – PSW).

The subject property is located within the jurisdiction of the Ministry of Northern Development, Mines, Natural Resources and Forestry’s (MNDMNRF) - Kemptville District and the Ministry of Environment, Conservation and Park’s (MECP) – Ottawa District.

There is confirmed Provincially Significant Wetland (PSW) present within the overall 29.7 hectare holding, and adjacent to the proposed development area. As such, the Town of Perth has required an EIS be completed for the subject property due to the presence of a PSW, as outlined in the *Town of Perth Official Plan* (Town of Perth, 2019). This EIS report assesses the potential impacts that the development of a residential subdivision may have upon the existing woodlands, natural heritage features, including Significant Woodlands and Wetlands and species at risk (SAR), and their habitat.

McIntosh Perry Consulting Engineers Ltd. (McIntosh Perry) was retained by Perthmore Development Co. Ltd. to carry out an EIS to assess the existing natural heritage features. This EIS summarizes the findings of the surveys, outlines potential impacts as a result of the proposed development, and provides recommendations in order to mitigate anticipated impacts on natural heritage features. The information contained in this report represents surveys undertaken in the spring and summer of 2019 and additional field review completed summer of 2022.

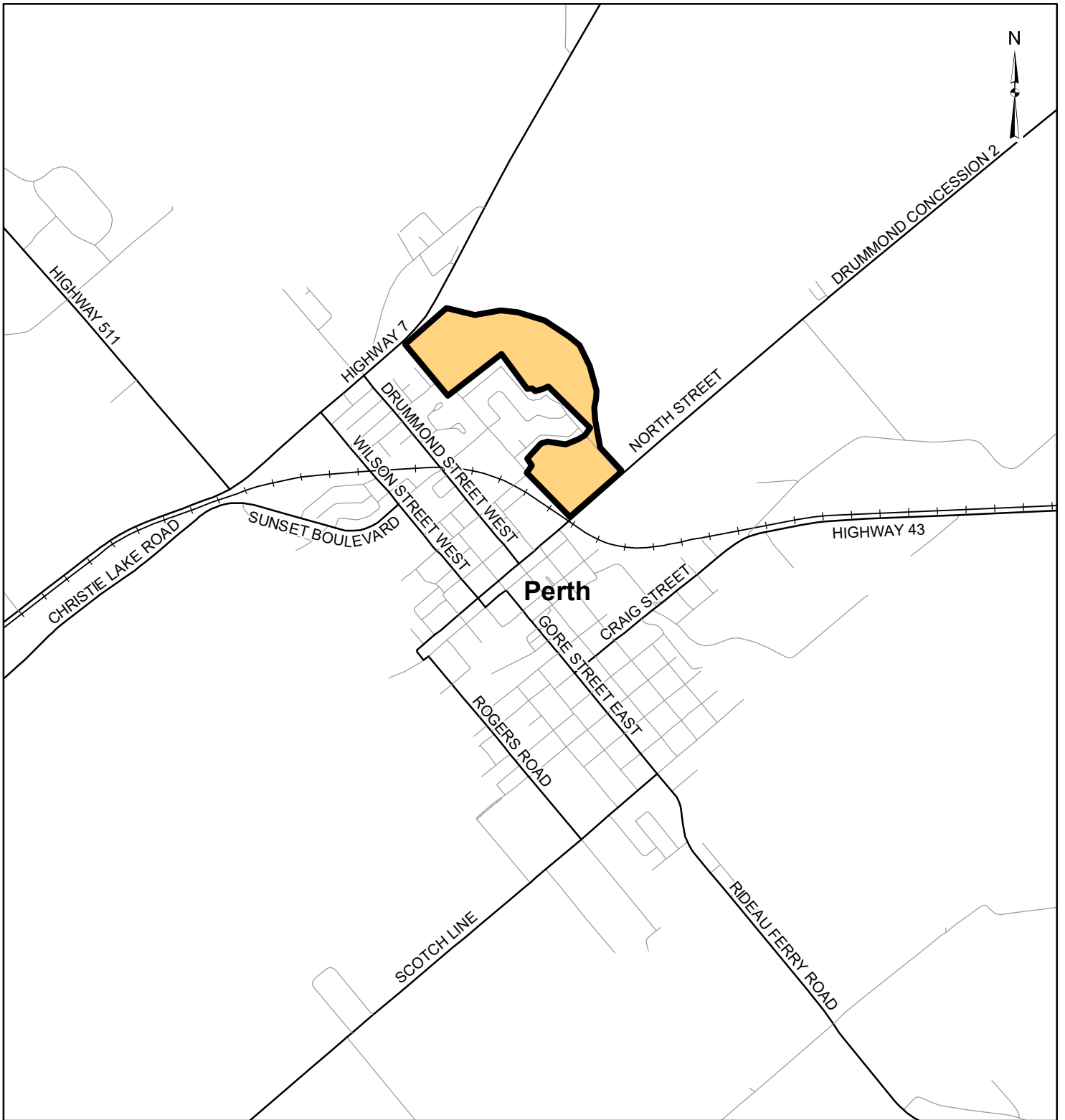

LEGEND

- Subject Property
- Local Road
- Major Road
- Waterbody

REFERENCE

Basedata provided by the Ontario Ministry of Natural Resources and Forestry, 2018.

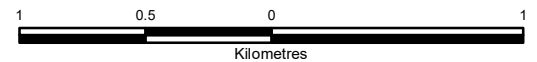

CLIENT:	PERTHMORE SUBDIVISION		
PROJECT:	EIS		
TITLE:	KEY PLAN		
McINTOSH PERRY <small>115 Walgreen Road, RR3, Carp, ON K0A1L0 Tel: 613-836-2184 Fax: 613-836-3742 www.mcintoshperry.com</small>	PROJECT NO: PP-13-9668	FIGURE:	1
	Date	Nov., 20, 2019	
	GIS	SK	
	Checked By	EP	

2.0 METHODOLOGY

In order to acquire information on habitat present within and adjacent to the area of the proposed development, field investigations were carried out on May 24, 2019 by E. Pohanka of McIntosh Perry as well as June 8, 17, and 22, 2019 by H. Lunn and July 15, 2022 by J. King (**Table 1**). The field investigations were carried out within the undeveloped and cleared areas of the subject property. The area surveyed will be hereafter referred to in this report as the “study area.” The field investigation was conducted to provide an inventory and assessment of the natural heritage features of the study area. The field investigation included the identification of the following features within the study area:

- Existing vegetation communities;
- Significant woody vegetation;
- Areas of critical or significant habitat (i.e., Significant Valleylands, Significant Woodlands, Significant Wildlife Habitat, PSW’s, etc.);
- Soil types;
- Areas of groundwater recharge and discharge, drainage patterns, watercourses, wetland habitat, other areas of surface water;
- SAR and their habitat, and
- Resident or migratory birds and other wildlife species.

Table 1 outlines activities carried out within the study area during the field investigations.

Table 1: Summary of Field Investigation Activities				
Date	Personnel Involved	Time of Survey	Weather Conditions	Purpose of Visit
May 24, 2019	E. Pohanka	6:45 a.m. to 10:30 a.m.	13 °C, overcast, light drizzle, low wind	Existing environmental conditions survey (including identification of vegetation and wildlife species present (avian included) and determining vegetation community boundaries) and species at risk habitat review.
June 8, 2019	H. Lunn	5:35 a.m. to 6:30 a.m.	9 °C, sunny, no precipitation, no wind	Avian survey and targeted Eastern Meadowlark/Bobolink survey.
June 17, 2019	H. Lunn	7:00 a.m. to 9:00 a.m.	10 °C, sunny, no precipitation, no wind	Avian survey and targeted Eastern Meadowlark/Bobolink survey. Wetland boundary delineation mapping and vegetation community mapping.
June 22, 2019	H. Lunn	5:30 a.m. to 6:45 a.m.	12 °C, sunny, no precipitation, light breeze	Targeted Eastern Meadowlark/Bobolink survey. Butternut health assessment.
July 15, 2022	J. King	9:00 a.m. to 10:00 a.m.	25 °C, sunny, no precipitation,	Updated vegetation mapping

Table 1: Summary of Field Investigation Activities

Date	Personnel Involved	Time of Survey	Weather Conditions	Purpose of Visit
			light breeze	

The vegetation communities observed within the study area were characterized using the Ecological Land Classification (ELC) protocol (Lee et al., 1998), and delineated on an aerial photograph. Significant Woodlands were identified through several criteria including tree species, age class, canopy, density, land area, etc. This was completed per the Natural Heritage Reference Manual (NHRM) and the Perth OP. Areas that represented Significant Woodlands were mapped in the field utilizing GPS coordinates and visual observations. Wetland boundaries associated with the study area were reclassified due to outdated modelling. This was conducted by walking through the study area and delineating the updated wetland boundaries using GPS coordinates and visual observations.

Migratory bird surveys were performed by conducting a walkthrough of the study area. The surveys began no later than 7:00 AM. The surveys included a review of nesting and migratory birds including nesting habitat. Direct nest searches were not undertaken during the surveys as this practice is not condoned by the Canadian Wildlife Service (e.g. the chance of harming the nest by leading predators to the nesting location is high, and the efficiency of detecting all nesting locations in complex habitats such as riparian corridor or mixed vegetation is low). Breeding evidence codes as used during the Ontario Breeding Bird Atlas (OBBA) were used to assign a likelihood of breeding within the study area based on observed behaviours of individual birds. These standardized codes determine whether the species is possibly, probably or confirmed to be breeding within the study area. Characteristics of habitat were also used to help interpret behaviours and breeding evidence. In concurrence with the migratory bird surveys, grassland SAR bird surveys were conducted in the Mixed Meadow (MEM) vegetation communities within the study area. Three (3) grassland SAR bird surveys were conducted no later than 7:00 AM on sunny days with no precipitation and little to no breeze. Visual and audial observations of grassland SAR birds were recorded.

During the field investigations, observations of wildlife species were made through sight, sound, and physical evidence.

Photographs were taken during the field investigations depicting vegetation communities and natural heritage features observed within the study area. This photographic record can be found in **Appendix A** of this report (**Photos 1 – 37**).

Background information on wildlife and plant species, and other significant natural heritage features known to occur within or adjacent to the study area was obtained from the following sources:

- The Natural Heritage Information Centre (NHIC) database accessed via the MNDMNR's Make a Map: Natural Heritage Areas (MNDMNR, 2019a). This search tool allows areas to be searched at up to 1 km² grid resolution and provides reports concerning rare species tracked by the NHIC. Information for each 1 km² square within the study area was reviewed for occurrences of rare species tracked by NHIC;
- The MNDMNR's Land Information Ontario (LIO) Metadata Management Tool (MNDMNR, 2019b). This tool contains information (e.g., location of PSW's, SAR element occurrences, etc.) licensed under the Open

Government Licence for Ontario;

- Data from the Ontario Breeding Bird Atlas Database (OBBA) was accessed from the data summaries page of the Atlas of the Breeding Birds of Ontario website (Bird Studies Canada, 2006). Information for each 10 km² grid square was reviewed for the study area;
- Ontario Reptile and Amphibian Atlas was accessed for the data summaries (Ontario Nature, 2019). Information for each 10 km² grid square was reviewed for the study area;
- Information from the *Tay River Subwatershed Report 2017* by Rideau Valley Conservation Authority (RVCA) (2017);
- Habitat in the study area was evaluated by use of aerial photography accessed through Google Earth aeriels and StreetView mapping (Maxar Technologies, 2019), and
- SAR listed in the *Town of Perth Official Plan: Appendix 10 - List of Endangered and Threatened Species* that are potentially found in the Town of Perth (Town of Perth, 2019).

3.0 DESCRIPTION OF THE SITE AND THE NATURAL ENVIRONMENT

3.1 Existing Land Use

At the time of the field investigations, most of the study area was undeveloped with the exception of a cleared areas near the center and west portions (**Photos 1 and 3**). The undeveloped portions of the study area consist of vegetated areas in a range of forest and wetland types. The cleared areas consist of regenerating fields and thickets as well as some piles of fill.

Schedule A: Land Use, of the *Town of Perth Official Plan (2019)*, identifies 'Environmental Protection Area' consisting of 'Natural Heritage Features' and 'PSW' towards the very southeast portion of the study area. A 120 m boundary of 'adjacent lands' to the PSW is also present within the study area which also located within the area designated 'Residential Areas'.

A 'Natural Heritage System' is defined by the *Provincial Policy Statement, 2020 (PPS)* as "...a system made up of natural heritage features and areas, linked by natural corridors which are necessary to maintain biological and geological diversity, natural functions, viable populations of indigenous species and ecosystems." Land uses adjacent to the subject property include residential property directly adjacent to the southwest and vacant lands and wetlands northeast, east, and southeast.

3.2 Natural Heritage System Components

The following background information was collected from various sources (refer to Section 2.0 of this report):

- According to the NHIC mapping reviewed and LIO data, the following natural features have been identified within the vicinity of the study area:
 - A portion of the study area is within/adjacent to the Perth Long Swamp, a PSW;
 - The following additional PSW's are present within 2 km of the study area: Blueberry Marsh, Grant Creek Wetland;
 - The Perth Blueberry Bog (Candidate Life Science ANSI) is within 2 km of the study area, and
 - The following SAR have been recorded within 2 km of the study area: Barn Swallow (*Hirundo rustica*), Bobolink (*Dolichonyx oryzivorus*), Eastern Meadowlark (*Sturnella magna*), Eastern Musk Turtle (*Sternotherus odoratus*), and Gray Ratsnake (Frontenac Axis population) (*Pantherophis spiloides*).

The PPS defines Significant Wetlands as "...an area identified as provincially significant by the Ontario Ministry of Natural Resources using evaluation procedures established by the Province..." (PPS, 2020). Section 8.6.4(b)(2.) of the *Town of Perth Official Plan (2019)*, identifies Provincially Significant wetlands as "...ecosystems which are important as habitat for a variety of plant and animal species, for water quality, flood control and water storage and recharge areas and for their value for passive recreation". The Perth Long Swamp was identified within/adjacent to the study area based on NHIC and LIO data. The boundaries of the wetland complex according to LIO data, shows the wetland occurring southeast of the study area (**Figure 3**). However, this data was determined to be historic (1987) and required updating. H. Lunn conducted a wetland evaluation to map the current boundaries of the PSW within the study area. **Figure 3** outlines the updated boundaries of the Perth Long Swamp within the study area contrasting with the outdated boundaries. The wetland drains southeast through

tributaries that cross under North Street. These tributaries drain into Tay River south of the study area. The new boundaries of the wetland do not significantly deviate from the previous boundaries with the exception of expansion of the boundaries southeast of the study area and a reduction towards the the northwest.

The PPS defines a Significant Woodland as “...an area which is ecologically important in terms of features such as species composition, age of trees and stand history; functionally important due to its contribution to the broader landscape because of its location, size or due to the amount of forest cover in the planning area...”. Section 8.6.4(e.)(1.) of the *Town of Perth Official Plan (2019)*, defines Significant Woodlands as “...areas which serve an important ecological function in the broader landscape because of their location, extent of forest cover, tree age and long-standing forest function, species composition and their potential as wildlife habitat”.

Several vegetation communities within and adjacent to the study area (refer to Section 3.5 of this report for information on vegetation communities present within the study area), were considered to be ‘Potentially Significant Woodland’ based on the *Town of Perth Official Plan (2019)*. The forested areas identified as Dry-Fresh Sugar Maple-Ironwood Deciduous Forest (FODM5-4), Ash Mineral Deciduous Swamp (SWD1), and Coniferous Forest (FOC) are within the ‘Potentially Significant Woodlands’ defined by Appendix 11 of the *Official Plan* (see **Figure 4**).

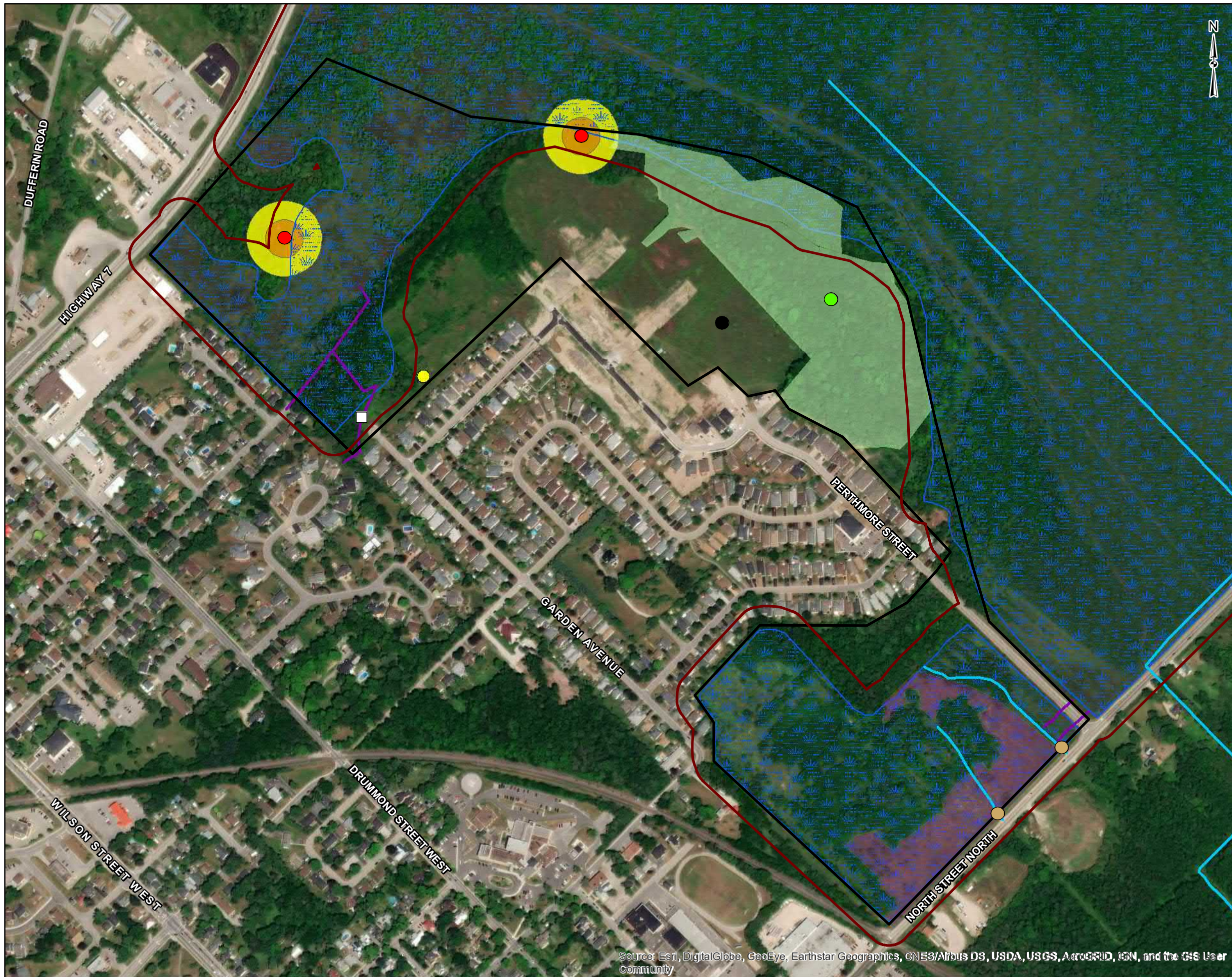

- LEGEND**
- Perthmore Boundary
 - Beaver Dam
 - Ditch
 - Watercourse
 - Provincially Significant Wetland
 - 30m Buffer of PSW (Provincially Significant Wetland)
 - Butternut
 - 25m Butternut Buffer
 - 50m Butternut Buffer
 - Common Grackle Nests
 - Eastern Meadowlark
 - Eastern Wood-pewee
 - Eastern Wood-pewee/
Wood Thrush Habitat
 - Potential Baitfish Spawning
Habitat (Seasonal)
 - Potential Northern Pike
Spawning Habitat (Seasonal)

REFERENCE
 GIS data provided by the Ontario Ministry of Natural Resources and Forestry, 2019.



CLIENT:	PERTHMORE SUBDIVISION	
PROJECT:	EIS	
TITLE:	NATURAL HERITAGE FEATURES	
McINTOSH PERRY <small>115 Walgreen Road, RR3, Carp, ON K0A1L0 Tel: 613-836-2184 Fax: 613-836-3742 www.mcintoshperry.com</small>	PROJECT NO: PP-13-9668	FIGURE:
	Date: Dec., 16, 2019	2
	GJS: SK	
	Checked By: EP	

Source: Esri, DigitalGlobe, GeoEye, Earthstar Geographics, CNES/Airbus DS, USDA, USGS, AeroGRID, IGN, and the GIS User Community

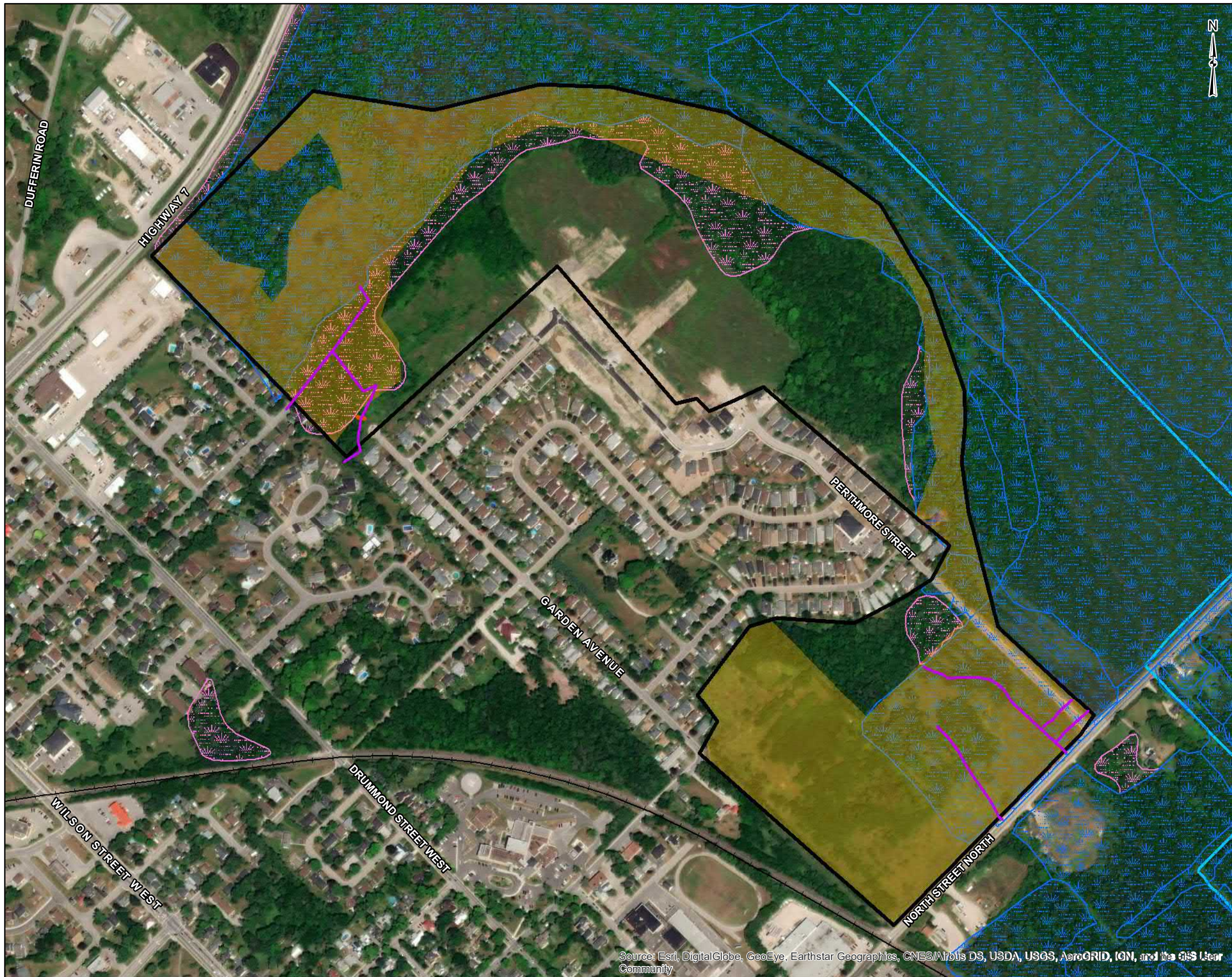

LEGEND

- Perthmore Boundary
- Beaver Dam
- Ditch
- Watercourse
- McIntosh Perry Updated PSW Boundary within Study Area Limits
- MNRF PSW Boundary
- MNRF Unevaluated Wetland Boundary

REFERENCE
 GIS data provided by the Ontario Ministry of Natural Resources and Forestry, 2019.



CLIENT:	PERTHMORE SUBDIVISION	
PROJECT:	EIS	
TITLE:	WETLAND RECLASSIFICATION MAPPING	
McINTOSH PERRY <small>115 Walgreen Road, RR3, Carp, ON K0A1L0 Tel: 613-836-2184 Fax: 613-836-3742 www.mcintoshperry.com</small>	PROJECT NO: PP-13-9668	FIGURE:
	Date	Nov., 20, 2019
	GIS	SK
	Checked By	EP
		3

Source: Esri, DigitalGlobe, GeoEye, Earthstar Geographics, CNES/Airbus DS, USDA, USGS, AeroGRID, IGN, and the GIS User Community

3.3 Landforms, Soils and Geology

The physiography of the study area is within the Great Lakes Basin. The bedrock geology of the study area consists of dolostone and sandstone of the Beekmantown Group (Ontario Geological Survey, 2010). According to the *Soils Map of Lanark County Ontario* (Canada Department of Agriculture, 1966), soils present within the study area include organic muck with very poor drainage in the PSW, and well drained sandy loam till southwest of the PSW.

3.4 Surface Water, Groundwater, Wetlands, and Fish Habitat

The property is located within the Tay River Subwatershed of the Rideau Valley Watershed managed by the Rideau Valley Conservation Authority (RVCA, 2017). Tributaries of the Tay River flow from the southeast end of the study area through culverts under North Street in a southeast direction. The tributaries drain surface water from the Perth Long Swamp PSW within the study area for approximately 990 m into the Tay River (RVCA, 2017). During the May 24, 2019 field investigation, the tributaries were flowing with an approximate depth of 0.5 m. The tributaries within the study area have an unknown thermal regime. Central Mudminnows (*Umbra limi*), bass (*Micropterus* spp.), sunfish (*Lepomis* spp.), and young-of-year (YOY) Northern Pike (*Esox lucius*) were recorded to be present within a connected tributary which crosses North Street east of the study area (personal observations made by J. King of McIntosh Perry). Graminoid vegetation within the study area upstream of the North Street culverts provide suitable spawning habitat for Northern Pike. The inlets of the culverts also provide suitable baitfish spawning habitat within the gravel riffles. These habitats are seasonal as these areas are influenced by fluctuating groundwater conditions.

During the field investigations, the soils were observed to have poor drainage as was evident with the wet soils and wetlands present in the study area. Standing water was present throughout the wetland areas of the study area (**Photos 8, 13, 25, and 35**). Potential groundwater was observed within the wetland due to oil-like films and iron staining on the water surface within the cattail marsh and ash mineral deciduous swamp areas of the wetland (**Photo 26**).

No well records were identified within the study area. A total of 103 wells are located within 500 m of the original study area. The well depths range from 0.4 m to 68.3 m. The well uses range from domestic water supply (46), industrial water supply (3), commercial water supply (17), irrigation (1), livestock (2), public water supply (1), monitoring (2) abandoned (7), and unknown use (24).

3.5 Vegetation Cover

Spring and summer vegetation surveys were completed on May 24 and June 17, 2019 and confirmed July 15, 2022. Habitat observed during the field investigations included several vegetation communities (**Photos 1, 3, 6, 8, 13, 14, 16, 17, 18, 20, 24, 25, 29, 30, 32, 34, 35, 37**). The following section outlines the existing vegetation communities identified within the study area. For a detailed map of vegetation communities present within the study area, refer to **Figure 4**. Photographs of the vegetation communities can be found in **Appendix A**. A complete listing of vegetation species observed within the study area during the field investigations is found in **Table 2**. SAR vegetation was observed within the study area during the June 17, 2019 field investigation. Two (2) Butternut (*Juglans cinerea*) trees were identified in the north end of the study area. No other nationally, provincially or regionally rare or endangered plant species were observed during the field investigation.

3.5.1 Vegetation Community 1: Mixed Meadow (MEM)

Vegetation Community 1 was classified through ELC as a Mixed Meadow (MEM) (**Photo 1 and 3**). This community lacked significant woody vegetation. It was previously cleared and is considered a disturbed area with herbaceous growth regenerating the area. The dominant species included grass (*Poaceae* spp.) and shrub willows (*Salix* spp.). This community was present in the center of the study area, northwest and northeast of the existing development. Additional MEM habitat was noted during the July 15, 2022 survey through recent vegetation removals. The remainder of Community 1 had recently been mown.

3.5.2 Vegetation Community 2: Green Ash Organic Deciduous Swamp (SWDO1-2)

Vegetation Community 2 was classified through ELC as a Green Ash Organic Deciduous Swamp (SWDO1-2) (**Photo 6 and 8**). This vegetation community is located on the west end of the study area adjacent to the western Mixed Meadow. Drains and ditch lines are present within this vegetation community. The community consisted of wet soils and vegetation dominated by green ash (*Fraxinus pennsylvanica*). The majority of this community is situated within the updated boundaries of the PSW.

3.5.3 Vegetation Community 3: Cattail Organic Shallow Marsh (MASO1-1)

Vegetation Community 3 was classified through ELC as a Cattail Shallow Marsh (MASO1-1) (**Photo 13**). This vegetation community is in the western corner of the study area. It is situated entirely within the updated boundaries of the PSW and there is a small, fragmented section of this community north of the main section. This community contains surface water and is dominated by broad-leaved cattail (*Typha latifolia*). Sparse stands of dead trees and shrubs are also present in this community.

3.5.4 Vegetation Community 4: Coniferous Forest (FOC)

Vegetation Community 4 was classified through ELC as a Coniferous Forest (FOC) (**Photo 14**). This vegetation community is in the western end of the study area. It is excluded from the updated boundaries of the PSW. The community consists of a mix of coniferous trees including white spruce (*Picea glauca*), eastern white-cedar (*Thuja occidentalis*), and balsam fir (*Abies balsamea*) as well as a mix of deciduous trees. This community extends to the southern side of Dufferin Street and fragments the Cattail Organic Shallow Marsh community. This community is designated as 'Potentially Significant Woodlands' based on the *Town of Perth Official Plan* (2019).

3.5.5 Vegetation Community 5: Shallow Marsh (MAS)

Vegetation Community 5 was classified through ELC as a Shallow Marsh (MAS) (**Photo 16**). This community is located in the north end of the study area. This vegetation community also exists in the south end of the study area between the existing development and the updated boundaries of the PSW. The features of this community are similar to those of the cattail organic shallow marsh; however, the shrubs are denser within the shallow marsh community. This community is situated entirely within the updated boundaries of the PSW. This vegetation community extends into adjacent lands within the PSW.

3.5.6 Vegetation Community 6: Fresh-Moist Lowland Deciduous Forest (FODM7)

Vegetation Community 6 was classified through ELC as a Fresh-Moist Lowland Deciduous Forest (FODM7) (**Photo**

17 and 18). This community is located between the two Mixed Meadow communities, outside of the updated PSW boundaries. Another portion of this community is present in the southeast end of the study area between the PSW and existing developed subdivision. The canopy of this community consists primarily of green ash with a mix of other deciduous trees. Understory species was dominated by common buckthorn (*Rhamnus cathartica*). A ridge created by a historic stone fence line is present within this community. The southeast portion of this community is designated as 'Potentially Significant Woodlands' based on the *Town of Perth Official Plan* (2019).

3.5.7 Vegetation Community 7: Dry-Fresh Sugar Maple-Ironwood Deciduous Forest (FODM5-4)

Vegetation Community 7 was classified through ELC as a Dry-Fresh Sugar Maple-Ironwood Deciduous Forest (FODM5-4) (**Photo 20**). This is a large community (approximately 20 acres) that begins in the north end between the Shallow Marsh and eastern Mixed Meadow communities, outside of the updated PSW boundaries and continues southeast around the Mixed Meadow. The canopy of this community is dominated by a mix of sugar maple (*Acer saccharum*) and ironwood (*Ostrya virginiana*). The stone wall ridge noted in vegetation community 6 continues within this vegetation community and curves eastward. This community contained very little understory and sparse ground cover dominated by broad-leaved toothwort (*Cardamine diphylla*) and Canada mayflower (*Maianthemum canadense*). This community is designated as 'Potentially Significant Woodlands' based on the *Town of Perth Official Plan* (2019).

3.5.8 Vegetation Community 8: Ash Mineral Deciduous Swamp (SWD1)

Vegetation Community 8 was classified through ELC as Ash Mineral Deciduous Swamp (SWD1) (**Photo 24 and 25**). This community is located along the eastern boundary of the study area from the north end to the south east end at Perthmore Road. It is entirely within the updated PSW boundaries. The community is dominated by a mix of green ash and black ash (*Fraxinus nigra*) with surface water creating vernal pools. There is very little understory; however, there is significant ground cover consisting of herbaceous wetland plants growing from the vernal pools and outside of the pools. This vegetation community extends into adjacent lands within the PSW. This community is designated as 'Potentially Significant Woodlands' based on the *Town of Perth Official Plan* (2019).

3.5.9 Vegetation Community 9: Willow Organic Deciduous Thicket Swamp (SWTO2)

Vegetation Community 9 was classified through ELC as a Willow Organic Deciduous Thicket Swamp (SWTO2) (**Photo 29 and 30**). This community is located in large fragments in the southern end of the study area. Areas of this community type exist on the east and west side of Perthmore Road, a small portion in the southwestern end of the study area, and a large portion in the centre of the south end of the study area. These areas consist of wet soils, often with surface water dominated by Bebb's willow (*Salix bebbiana*), peachleaf willow (*Salix amygdaloides*), and red-osier dogwood (*Cornus sericea*). Ground cover consists of marsh horsetail (*Equisetum palustre*) and purple loosestrife (*Lythrum salicaria*). All of these areas are within the updated PSW boundaries.

3.5.10 Vegetation Community 10: Cattail Graminoid Organic Meadow Marsh (MAMO1-2)

Vegetation Community 10 was classified through ELC as a Cattail Graminoid Organic Meadow Marsh (MAMO1-2) (**Photo 34 and 35**). This community is located in on the east and west sides of the large Willow Organic Deciduous Thicket Swamp in the centre of the southern end of the study area. This community consists mainly of broad-leaved cattails, but also contains significant amounts of reed canary grass (*Phalaris arundinacea*). Sparse common

buckthorn is also present. The soil in these communities are wet and often have surface water.

3.5.11 Vegetation Community 11: Fresh-Moist Poplar Deciduous Forest (FODM8-1)

Vegetation Community 11 was classified through ELC as a Fresh-Moist Poplar Deciduous Forest (FODM8-1) (**Photo 37**). This community is on the west end of a pathway between North Street and Garden Avenue, adjacent to the south end of the study area. This community is dominated by trembling aspen (*Populus tremuloides*) and balsam poplar (*Populus balsamifera*) as well as a mix of other deciduous tree species. A thick understory is present consisting of common buckthorn, Tatarian honeysuckle (*Lonicera tatarica*), and shrub willows. Refer to **Table 2** for a complete listing of species observed within the study area.

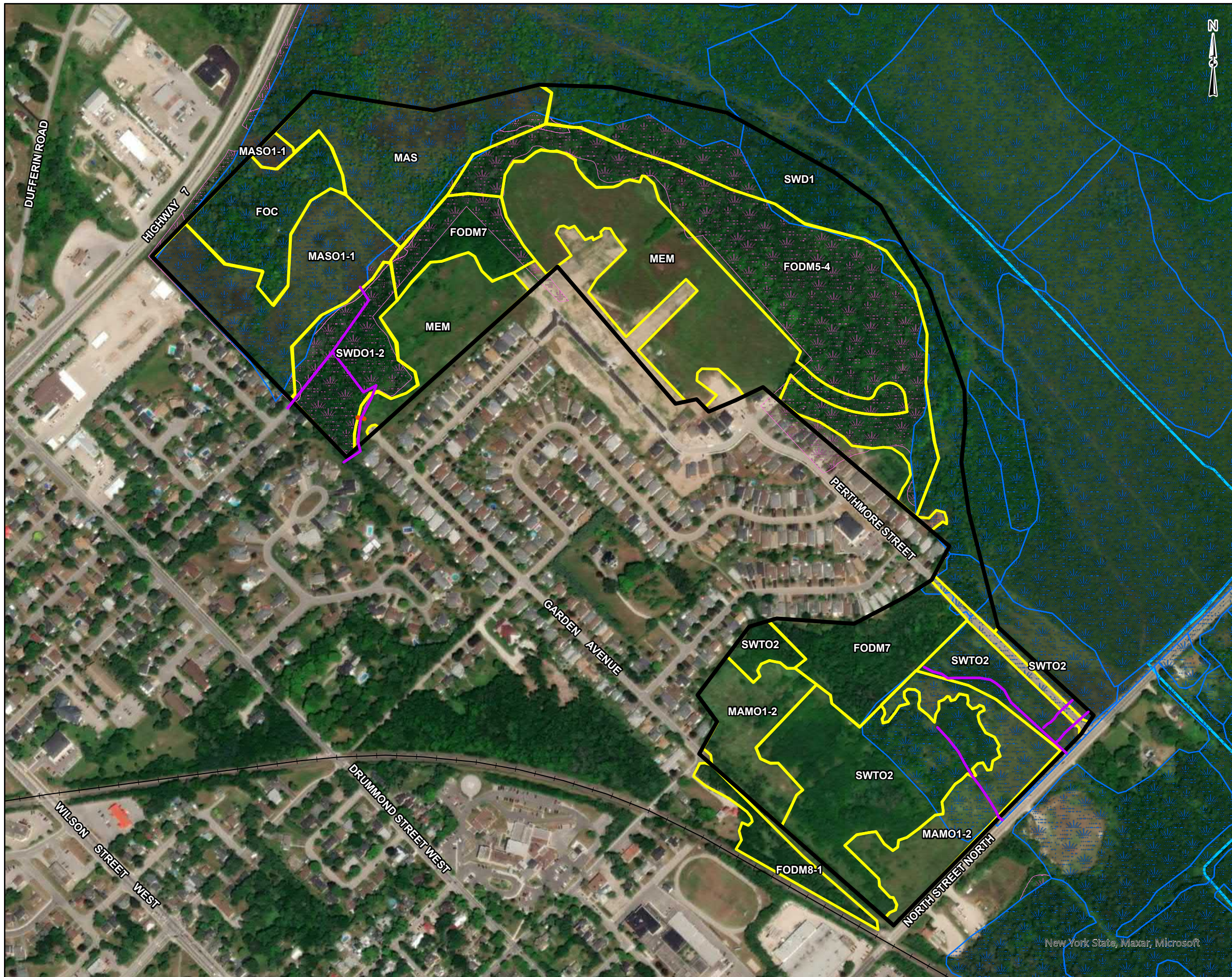

- LEGEND**
- Perthmore Boundary
 - Beaver Dam
 - Ditch
 - Watercourse
 - PSW Wetland
 - Wetland Not Evaluated
 - Vegetation Community
- FOC Coniferous Forest
 FODM5-4 Dry-Fresh Sugar Maple-Ironwood Deciduous Forest Type
 FODM7 Fresh - Moist Lowland Deciduous Forest Ecosite
 FODM8-1 Fresh - Moist Poplar Deciduous Forest Type
 MAMO1-2 Cattail Graminoid Organic Meadow Marsh Type
 MAS Shallow Marsh
 MASO1-1 Cattail Organic Shallow Marsh Type
 MEM Mixed Meadow
 SWD1 Ash Mineral Deciduous Swamp Ecosite
 SWDO1-2 Green Ash Organic Deciduous Swamp Type
 SWTO2 Willow Organic Deciduous Thicket Swamp Ecosite

REFERENCE
 GIS data provided by the Ontario Ministry of Natural Resources and Forestry, 2022.



CLIENT:	PERTHMORE SUBDIVISION	
PROJECT:	EIS	
TITLE:	VEGETATION COMMUNITIES	
McINTOSH PERRY <small>115 Walgreen Road, RR3, Carp, ON K0A1L0 Tel: 613-836-2184 Fax: 613-836-3742 www.mcintoshperry.com</small>	PROJECT NO: PP-13-9668	FIGURE:
	Date	Jul., 15, 2022
	GIS	MG
	Checked By	JK
		4

Table 2: Vegetation Species observed within the Study Area

Common Name	Scientific Name	Common Name	Scientific Name
Tree Species			
American beech	<i>Fagus grandifolia</i>	green ash	<i>Fraxinus pennsylvanica</i>
balsam fir	<i>Abies balsamea</i>	ironwood	<i>Ostrya virginiana</i>
balsam poplar	<i>Populus balsamifera</i>	largetooth aspen	<i>Populus grandidentata</i>
basswood	<i>Tilia americana</i>	Manitoba maple	<i>Acer negundo</i>
black ash	<i>Fraxinus nigra</i>	paper birch	<i>Betula papyrifera</i>
black cherry	<i>Prunus serotina</i>	red maple	<i>Acer rubrum</i>
black spruce	<i>Picea mariana</i>	silver maple	<i>Acer saccharinum</i>
black walnut	<i>Juglans nigra</i>	sugar maple	<i>Acer saccharum</i>
bur oak	<i>Quercus macrocarpa</i>	trembling aspen	<i>Populus tremuloides</i>
Butternut	<i>Juglans cinerea</i>	white elm	<i>Ulmus americana</i>
eastern white pine	<i>Pinus strobus</i>	white spruce	<i>Picea glauca</i>
eastern white cedar	<i>Thuja occidentalis</i>	white willow	<i>Salix alba</i>
European white poplar	<i>Populus alba</i>		
Shrub Species			
Bebb's willow	<i>Salix bebbiana</i>	high-bush cranberry	<i>Viburnum trilobum</i>
black currant	<i>Ribes nigrum</i>	nannyberry	<i>Viburnum lentago</i>
black elderberry	<i>Sambucus canadensis</i>	narrow-leaved meadowsweet	<i>Spiraea alba</i>
bunchberry	<i>Cornus canadensis</i>	peach-leaved willow	<i>Salix amygdaloides</i>
choke cherry	<i>Prunus virginiana</i>	red-osier dogwood	<i>Cornus sericea</i>
common barberry	<i>Berberis vulgaris</i>	riverbank grape	<i>Vitis riparia</i>
common blackberry	<i>Rubus allegheniensis</i>	shrub willow	<i>Salix</i> spp.
common buckthorn	<i>Rhamnus cathartica</i>	speckled alder	<i>Alnus incana</i>
common prickly-ash	<i>Zanthoxylum americanum</i>	Tatarian honeysuckle	<i>Lonicera tatarica</i>
fragrant sumac	<i>Rhus aromatica</i>	Virginia creeper	<i>Parthenocissus quinquefolia</i>
glossy buckthorn	<i>Frangula alnus</i>	western poison-ivy	<i>Toxicodendron rydbergii</i>
hawthorn	<i>Crataegus</i> spp.	wild red raspberry	<i>Rubus strigosus</i>
Herbaceous Species			

Table 2: Vegetation Species observed within the Study Area

Common Name	Scientific Name	Common Name	Scientific Name
bittersweet nightshade	<i>Solanum dulcamara</i>	naked bishop's-cap	<i>Mitella nuda</i>
bladder campion	<i>Silene vulgaris</i>	northern dewberry	<i>Rubus flagellaris</i>
bladder sedge	<i>Carex intumescens</i>	oak fern	<i>Gymnocarpium</i> spp.
Blue-stem goldenrod	<i>Solidago caesia</i>	one-sided shinleaf	<i>Orthilla secunda</i>
bracken fern	<i>Pteridium aquilinum</i>	orange hawkweed	<i>Pilosella aurantiaca</i>
broad-leaved cattail	<i>Typha latifolia</i>	orchard grass	<i>Dactylis</i> spp.
bull thistle	<i>Cirsium vulgare</i>	ostrich fern	<i>Matteuccia struthiopteris</i>
butter-and-eggs	<i>Linaria vulgaris</i>	ox-eye daisy	<i>Leucanthemum vulgare</i>
Canada anemone	<i>Anemone canadensis</i>	Pennsylvania sedge	<i>Carex pennsylvanica</i>
Canada lettuce	<i>Lactuca canadensis</i>	phragmites	<i>Phragmites australis australis</i>
Canada mayflower	<i>Maianthemum canadense</i>	purple loosestrife	<i>Lythrum salicaria</i>
coltsfoot	<i>Tussilago farfara</i>	red baneberry	<i>Actaea rubra</i>
common burdock	<i>Arctium minus</i>	red clover	<i>Trifolium pratense</i>
common dandelion	<i>Taraxacum officinale</i>	reed canary grass	<i>Phalaris arundinacea</i>
common evening-primrose	<i>Oenothera biennis</i>	rough cinquefoil	<i>Potentilla norvegica</i>
common helleborine	<i>Epipactis helleborine</i>	rough horsetail	<i>Equisetum hyemale</i>
common milkweed	<i>Asclepias syriaca</i>	sensitive fern	<i>Onoclea sensibilis</i>
common yarrow	<i>Achillea millefolium</i>	skunk-cabbage	<i>Symplocarpus foetidus</i>
cow vetch	<i>Vicia cracca</i>	spinulose woodfern	<i>Dryopteris carthusiana</i>
curled dock	<i>Rumex crispus</i>	spotted jewelweed	<i>Impatiens capensis</i>
Dame's-rocket	<i>Hesperis matronalis</i>	spotted Joe-pye-weed	<i>Eutrochium maculatum</i>
dwarf raspberry	<i>Rubus pubescens</i>	spreading dogbane	<i>Apocynum androsaemifolium</i>
early meadow-rue	<i>Thalictrum dioicum</i>	stinging nettle	<i>Urtica dioica</i>
enchanter's nightshade	<i>Circaea lutetiana</i>	tall buttercup	<i>Ranunculus acris</i>
false Solomon's-seal	<i>Maianthemum racemosum</i>	Timothy grass	<i>Phleum pretense</i>
field forget-me-not	<i>Myosotis arvensis</i>	trout-lily	<i>Erythronium americanum</i>
field horsetail	<i>Equisetum arvense</i>	two-leaved toothwort	<i>Cardamine dyphilla</i>
field pennycress	<i>Thlaspi arvense</i>	viper's bugloss	<i>Echium vulgare</i>

Table 2: Vegetation Species observed within the Study Area

Common Name	Scientific Name	Common Name	Scientific Name
garlic mustard	<i>Allaria petiolate</i>	watercress	<i>Nasturtium officinale</i>
goat's-beard	<i>Tragopogon dubius</i>	white avens	<i>Geum canadense</i>
goldenrod	<i>Solidago</i> spp.	white baneberry	<i>Actaea pachypoda</i>
ground-ivy	<i>Glechoma hederacea</i>	whorled chickweed	<i>Mollugo verticillate</i>
herb-Robert	<i>Geranium robertianum</i>	wild parsnip	<i>Pastinaca sativa</i>
Jack-in-the-pulpit	<i>Tussilago farfara</i>	wild strawberry	<i>Fragaria virginiana</i>
king-devil	<i>Pilosella caespitosa</i>	woolly blue violet	<i>Viola sororia</i>
lily-of-the-valley	<i>Conallaria majalis</i>	wormseed mustard	<i>Erysimum cheiranthoides</i>
marsh horsetail	<i>Equisetum pratense</i>	yellow violet	<i>Viola pubescens</i>
marsh marigold	<i>Caltha palustris</i>		

3.6 Habitat for Species at Risk & Significant Wildlife Habitat

Background information obtained from the sources listed in Section 2.0 of this report, indicated that SAR and their habitat were potentially present within the study area. These species have been listed in **Table 3**. Based on habitat observed during the field investigations and direct observation of SAR, a determination was made as to whether these species had the potential to be or were present within the study area (**Table 3**).

Table 3: Species at Risk Potentially or Confirmed to be Present within the Study Area				
*Common Name	Scientific Name	Provincial Status (ESA, 2007)	Federal Status (SARA Schedule 1)	Potential/Unconfirmed or Confirmed Habitat Present within Property Boundaries
Plants				
Butternut ⁵	<i>Juglans cinerea</i>	Endangered	Endangered	Confirmed present in the study area
Insects				
Monarch ⁵	<i>Danaus plexippus</i>	Special Concern	Special Concern	No habitat
Amphibians				
Western Chorus Frog ²	<i>Pseudacris triseriata</i>	No Status	Threatened	Potential/Unconfirmed
Turtles				
Blanding’s Turtle ^{2, 5}	<i>Emydoidea blandingii</i>	Threatened	Threatened	Potential/Unconfirmed
Common Snapping Turtle ^{2, 5}	<i>Chelydra serpentina</i>	Special Concern	Special Concern	Potential/Unconfirmed
Eastern Musk Turtle ^{2, 5}	<i>Sternotherus odoratus</i>	Special Concern	Special Concern	No habitat
Snakes and Lizards				
Eastern Milksnake ^{2, 5}	<i>Lampropeltis triangulum triangulum</i>	No Status	Special Concern	Potential/Unconfirmed
Eastern Ribbonsnake ^{2, 5}	<i>Thamnophis sauritus sauritus</i>	Special Concern	Threatened	Potential/Unconfirmed
Gray Ratsnake ²	<i>Pantherophis spiloides</i>	Endangered	Threatened	No habitat
Birds				
Barn Swallow ^{3, 4}	<i>Hirundo rustica</i>	Threatened	Threatened	No habitat
Black Tern ⁵	<i>Chlidonias niger</i>	Special Concern	N/A	No habitat
Bobolink ^{3, 5}	<i>Dolichonyx</i>	Threatened	Threatened	Marginal habitat only

Table 3: Species at Risk Potentially or Confirmed to be Present within the Study Area

*Common Name	Scientific Name	Provincial Status (ESA, 2007)	Federal Status (SARA Schedule 1)	Potential/Unconfirmed or Confirmed Habitat Present within Property Boundaries
	<i>oryzivorus</i>			
Canada Warbler ⁵	<i>Cardellina Canadensis</i>	Special Concern	Threatened	No habitat
Chimney Swift ^{3, 5}	<i>Chaetura pelagica</i>	Threatened	Threatened	No habitat
Common Nighthawk ^{3, 5}	<i>Chordeiles minor</i>	Special Concern	Threatened	No habitat
Eastern Meadowlark ^{3, 5}	<i>Sturnella magna</i>	Threatened	Threatened	Marginal habitat only
Eastern Whip-poor-will ⁵	<i>Antrostomus vociferous</i>	Threatened	Threatened	No habitat
Eastern Wood-pewee ^{3, 5}	<i>Contopus virens</i>	Special Concern	Special Concern	Confirmed present within the study area
Evening Grosbeak ⁵	<i>Coccothraustes vespertinus</i>	Special Concern	No Status	No habitat
Golden-winged Warbler ⁵	<i>Vermivora chrysoptera</i>	Special Concern	Threatened	No habitat
Grasshopper Sparrow ^{3, 5}	<i>Ammodramus savannarum</i>	Special Concern	Special Concern	Marginal habitat only
Least Bittern ⁵	<i>Ixobrychus exilis</i>	Threatened	Threatened	Potential/Unconfirmed
Rusty Blackbird ⁵	<i>Euphagus carolinus</i>	Special Concern	Special Concern	No habitat
Short-eared Owl ⁵	<i>Asio flammeus</i>	Special Concern	Special Concern	No habitat
Wood Thrush ³	<i>Hylocichla mustelina</i>	Special Concern	Threatened	Confirmed present within the study area
Mammals				
Eastern Small-footed Myotis ⁵	<i>Myotis leibii</i>	Endangered	N/A	No habitat
Little Brown Myotis ⁵	<i>Myotis lucifugus</i>	Endangered	Endangered	No habitat
Northern Myotis ⁵	<i>Myotis septentrionalis</i>	Endangered	Endangered	No habitat
Tri-coloured Bat ⁵	<i>Perimyotis subflavus</i>	Endangered	Endangered	No habitat

*This table was assembled from various sources of background information. The following information sources were consulted to compile background information: 1 – LIO geodatabase (MNDMNRF, 2019b); 2 – Ontario Reptile and Amphibian Atlas (Ontario Nature, 2019); 3 – Atlas of the Breeding Birds of Ontario (Bird Studies Canada et al., 2006); 4 – NHIC data (MNDMNRF, 2019a); 5 – General range

Of the SAR identified by background information as potentially present within the vicinity of the study area, habitat observed during the field investigation within the study area does not appear to be suitable for the life processes of the following SAR: Monarch, Western Chorus Frog, Eastern Musk Turtle, Gray Ratsnake, Barn Swallow, Black Tern, Bobolink, Canada Warbler, Chimney Swift, Common Nighthawk, Eastern Meadowlark, Eastern Whip-poor-will, Evening Grosbeak, Golden-winged Warbler, Grasshopper Sparrow, Rusty Blackbird, Short-eared Owl, Eastern Small-footed Myotis, Little Brown Myotis, Northern, and Tri-colored Bat. In addition, although habitat was observed to be suitable for the Eastern Milksnake and Eastern Ribbonsnake, these species were not observed to be present within the study area, or within 50 m of the study area. These species utilize a variety of habitats and are not likely to rely directly on the study area for significant life processes.

An Eastern Meadowlark was heard calling in an agitated behaviour within the Mixed Meadow (MEM) in the centre of the study area during the June 8, 2019 field investigation. Subsequent targeted surveys were conducted during appropriate times of day and during the breeding period to determine if this species was utilizing the Mixed Meadow for breeding habitat. No other observation of this species or other grassland SAR birds were recorded during the field investigations. The individual Eastern Meadowlark observed on June 8, 2019 was likely in the process of searching for appropriate breeding habitat within the study area and vacated the area without establishing territory. It was determined that no suitable habitat for grassland SAR birds is present within or adjacent to the study area.

Areas of the Ash Mineral Deciduous Swamp (SWD1) provide potential habitat for Western Chorus Frog where there are seasonal standing pools of water. Although targeted surveys were not completed for this species, no observation or calls were recorded of this species during any field investigation.

Suitable habitat for the following species was deemed to be potentially present within the study area, during the 2019 field investigations: Butternut, Common Snapping Turtle, Blanding's Turtle, Least Bittern, Wood Thrush and Eastern Wood-pewee.

The Butternut is listed as 'Endangered' under the *Endangered Species Act (2007) (ESA)* and the *Species at Risk Act (2002) (SARA)*. Habitat for this species and individuals of this species are afforded protection. Habitat is available within the study area due to the wide range of habitat preferences for Butternuts in which to grow. Butternuts are shade intolerant and prefer open areas but often become crowded out by other pioneer species (i.e. regenerating areas). Two (2) Butternuts were identified and located within the study area (however outside of the area to be disturbed for Phase 6) during the June 8, 2019 field investigation. Both individuals were mature trees (**Photos 15 and 23**). One of the Butternuts was identified within the Coniferous Forest (FOC) in the northwest end of the study area and the other was identified within the Dry-Fresh Sugar Maple-Ironwood Deciduous Forest (FODM5-4) in the north end of the study area. Under the ESA, individuals must be assessed by a qualified Butternut Health Inspector to determine the general health and viability of the individual to resist the butternut canker (*Sirococcus clavignenti-juglandacearum*) and produce immune offspring.

Suitable habitat for Common Snapping Turtle and Blanding's Turtle is available in the study area within the PSW. The Common Snapping Turtle is listed as 'Special Concern' under the ESA and SARA and does not receive habitat protection. The Blanding's Turtle is listed as 'Threatened' under the ESA and SARA and receives habitat protection. Several of the vegetation communities in the study area as parts of the PSW (i.e. MASO1-1, MAS, SWTO2, SWD1,

and MAMO1-2) provide suitable foraging and migration habitat for these species. No distinct areas of open water marsh with depth were noted during the field reviews as suitable overwintering habitat. Potential nesting habitat for these species was observed within the study area in the form of gravel road shoulders along Perthmore Road as well as adjacent to the study area on North Street and Dufferin Street. However, no nests, evidence of nesting, or individual Common Snapping Turtles or Blanding's Turtles were observed during the 2019 field investigations. No records of Blanding's Turtles were found within 2 km of the study area.

Potential breeding habitat for the Least Bittern is also available in the open wetland areas of the PSW within the study area which contain narrow leaved emergent herbaceous vegetation (MAS and MASO1-1). This species is listed as 'Threatened' under the ESA and SARA and receives habitat protection. This species was not observed or heard calling during any of the field investigations. Targeted studies in Long Swamp in 2020 for Least Bittern along Highway 7 did not yield any sightings. No records were found of this species breeding within or adjacent to the study area.

The Eastern Wood-pewee is listed as 'Special Concern' under the ESA and SARA. The Wood Thrush is listed as 'Special Concern' under the ESA and 'Threatened' under the SARA. The habitat for these species is not afforded protection under the ESA or SARA. However, individuals of these species, their eggs, nest and fledglings are protected under the *Migratory Birds Convention Act* (1994) (MBCA). The Eastern Wood-pewee is a habitat generalist which will utilize a variety of habitats for nesting and foraging, however it prefers edge habitat near water. The Wood Thrush breeds in deciduous and mixed forests containing ironwood and oaks where the trees are over 15 m tall with a moderate understory and open floor consisting of moist soils, decaying leaf litter, and water nearby. During the June 8 and June 22, 2019 field investigations, an Eastern Wood-pewee and Wood Thrush were observed within the Dry-Fresh Sugar Maple-Ironwood Deciduous Forest (FODM5-4) vegetation community in the centre of the study area. The individuals were displaying territorial behaviour (singing males) within suitable habitat during the breeding season of these species. Suitable habitat for these species is present within the Dry-Fresh Sugar Maple-Ironwood Deciduous Forest (FODM5-4) vegetation community of the study area.

3.7 Wildlife

The study area is in the Smiths Falls Ecodistrict (6E-11) of the Lake Simcoe-Rideau Ecozone (6E) within the Mixedwood Plains Ecozone (Ecological Stratification Working Group, 1996). Characteristic wildlife present within this Ecozone include: northern raccoon (*Procyon lotor*), striped skunk (*Mephitis mephitis*), white-tailed deer (*Odocoileus virginianus*), groundhog (*Marmota monax*), waterfowl, turtles, snakes, and various bird species (Crins, et al., 2009).

The following section outlines the existing wildlife observations from the field investigations conducted within the study area. **Table 4** lists the species observed during the 2019 field investigations. Habitat present within the study area represented appropriate breeding/nesting/foraging habitat for all wildlife species observed with the exception of the Canada Goose (*Branta canadensis*) and Ring-billed Gull (*Larus delawarensis*).

Table 4: Wildlife Species Observed within the Study Area

Common Name	Scientific Name	Resident/Seasonally	Evidence
Snakes & Lizards			
Eastern Gartersnake	<i>Thamnophis sirtalis sirtalis</i>	Resident	Visual observation
Birds			
Alder Flycatcher	<i>Empidonax alnorum</i>	Seasonally	Singing male, within appropriate breeding habitat, during appropriate breeding season
American Bittern	<i>Botaurus lentiginosus</i>	Seasonally	Singing male, within appropriate breeding habitat, during appropriate breeding season
American Crow	<i>Corvus brachyrhynchos</i>	Resident	Visual observation, within appropriate breeding habitat, during appropriate breeding season
American Goldfinch	<i>Spinus tristis</i>	Seasonally	Visual observation, within appropriate breeding habitat, during appropriate breeding season
American Robin	<i>Turdus migratorius</i>	Seasonally	Singing male, within appropriate breeding habitat, during appropriate breeding season
Baltimore Oriole	<i>Icterus galbula</i>	Seasonally	Singing male, within appropriate breeding habitat, during appropriate breeding season
Black-and-white Warbler	<i>Mniotilta varia</i>	Seasonally	Singing male, within appropriate breeding habitat, during appropriate breeding season
Black-billed Cuckoo	<i>Coccyzus erythrophthalmus</i>	Seasonally	Singing male, within appropriate breeding habitat, during appropriate breeding season
Black-capped Chickadee	<i>Poecile atricapilla</i>	Resident	Visual observation, within appropriate breeding habitat, during appropriate breeding season
Black-throated Green Warbler	<i>Setophaga virens</i>	Seasonally	Singing male, within appropriate breeding habitat, during appropriate breeding season
Blue Jay	<i>Cyanocitta cristata</i>	Resident	Visual observation, within appropriate breeding habitat, during appropriate breeding season

Table 4: Wildlife Species Observed within the Study Area

Common Name	Scientific Name	Resident/Seasonally	Evidence
Canada Goose	<i>Branta canadensis</i>	Seasonally	Flyover
Chestnut-sided Warbler	<i>Setophaga pensylvanica</i>	Seasonally	Singing male, within appropriate breeding habitat, during appropriate breeding season
Chipping Sparrow	<i>Spizella passerine</i>	Seasonally	Singing male, within appropriate breeding habitat, during appropriate breeding season
Common Grackle	<i>Quiscalus quiscula</i>	Seasonally	Visual observation, within appropriate breeding habitat, during appropriate breeding season
Common Yellowthroat	<i>Geothlypis trichas</i>	Seasonally	Singing male, within appropriate breeding habitat, during appropriate breeding season
Downy Woodpecker	<i>Dryobates pubescens</i>	Resident	Visual observation, within appropriate breeding habitat, during appropriate breeding season
Eastern Meadowlark	<i>Sturnella magna</i>	Seasonally	Agitated calls/behaviour of an adult
Eastern Phoebe	<i>Sayornis phoebe</i>	Seasonally	Singing male, within appropriate breeding habitat, during appropriate breeding season
Eastern Towhee	<i>Pipilo erythrophthalmus</i>	Seasonally	Visual observation, within appropriate breeding habitat, during appropriate breeding season
Eastern Wood-pewee	<i>Contopus virens</i>	Seasonally	Singing male, within appropriate breeding habitat, during appropriate breeding season
European Starling	<i>Sturnus vulgaris</i>	Resident	Visual observation, within appropriate breeding habitat, during appropriate breeding season
Great Crested Flycatcher	<i>Myiarchus crinitus</i>	Seasonally	Singing male, within appropriate breeding habitat, during appropriate breeding season
Mourning Dove	<i>Zenaida macroura</i>	Resident	Singing male, within appropriate breeding habitat, during appropriate breeding season
Northern Cardinal	<i>Cardinalis cardinalis</i>	Resident	Singing male, within appropriate breeding habitat, during appropriate breeding season

Table 4: Wildlife Species Observed within the Study Area

Common Name	Scientific Name	Resident/Seasonally	Evidence
Northern Flicker	<i>Colaptes auratus</i>	Resident	Visual observation, within appropriate breeding habitat, during appropriate breeding season
Pileated Woodpecker	<i>Dryocopus pileatus</i>	Resident	Nest holes observed
Purple Finch	<i>Haemorhous purpureus</i>	Resident	Singing male, within appropriate breeding habitat, during appropriate breeding season
Red-eyed Vireo	<i>Vireo olivaceus</i>	Seasonally	Singing male, within appropriate breeding habitat, during appropriate breeding season
Red-winged Blackbird	<i>Agelaius phoeniceus</i>	Seasonally	Singing male, within appropriate breeding habitat, during appropriate breeding season
Ring-billed Gull	<i>Larus delawarensis</i>	Resident	Flyover
Rock Pigeon	<i>Columba livia</i>	Resident	Visual observation, within appropriate breeding habitat, during appropriate breeding season
Rose-breasted Grosbeak	<i>Pheucticus ludovicianus</i>	Seasonally	Singing male, within appropriate breeding habitat, during appropriate breeding season
Savannah Sparrow	<i>Passerculus sandwichensis</i>	Seasonally	Singing male, within appropriate breeding habitat, during appropriate breeding season
Song Sparrow	<i>Melospiza melodia</i>	Seasonally	Singing male, within appropriate breeding habitat, during appropriate breeding season
Sora	<i>Porzana Carolina</i>	Seasonally	Singing male, within appropriate breeding habitat, during appropriate breeding season
Swainson's Thrush	<i>Catharus ustulatus</i>	Seasonally	Visual observation, within appropriate breeding habitat, during appropriate breeding season
Swamp Sparrow	<i>Melospiza georgiana</i>	Seasonally	Singing male, within appropriate breeding habitat, during appropriate breeding season
Tree Swallow	<i>Tachycineta bicolor</i>	Seasonally	Visual observation, within appropriate breeding habitat, during appropriate breeding season

Table 4: Wildlife Species Observed within the Study Area

Common Name	Scientific Name	Resident/Seasonally	Evidence
Veery	<i>Catharus fuscescens</i>	Seasonally	Singing male, within appropriate breeding habitat, during appropriate breeding season
Warbling Vireo	<i>Vireo gilvus</i>	Seasonally	Singing male, within appropriate breeding habitat, during appropriate breeding season
White-breasted Nuthatch	<i>Sitta carolinensis</i>	Resident	Singing male, within appropriate breeding habitat, during appropriate breeding season
Wild Turkey	<i>Meleagris gallopavo</i>	Resident	Visual observation, within appropriate breeding habitat, during appropriate breeding season
Wilson's Snipe	<i>Gallinago gallinago</i>	Seasonally	Singing male, within appropriate breeding habitat, during appropriate breeding season
Winter Wren	<i>Troglodytes hiemalis</i>	Seasonally	Singing male, within appropriate breeding habitat, during appropriate breeding season
Wood Thrush	<i>Hylocichla mustelina</i>	Seasonally	Singing male, within appropriate breeding habitat, during appropriate breeding season
Yellow Warbler	<i>Setophaga petechia</i>	Seasonally	Singing male, within appropriate breeding habitat, during appropriate breeding season
Yellow-bellied Sapsucker	<i>Sphyrapicus varius</i>	Seasonally	Singing male, within appropriate breeding habitat, during appropriate breeding season
Mammals			
eastern chipmunk	<i>Tamias striatus</i>	Resident	Visual observation
eastern cottontail	<i>Sylvilagus floridanus</i>	Resident	Visual observation, scat observed
eastern gray squirrel	<i>Sciurus carolinensis</i>	Resident	Visual observation
groundhog	<i>Marmota monax</i>	Resident	Dens
North American beaver	<i>Castor canadensis</i>	Resident	Chewed branches observed, small beaver dam in ditch line
red squirrel	<i>Tamiasciurus hudsonicus</i>	Resident	Visual observation
white-tailed deer	<i>Odocoileus virginianus</i>	Resident	Tracks

For those observations of male birds singing and visual observations of males, within appropriate breeding habitat, during the appropriate breeding season, this quality of breeding evidence represents “possible breeder,” under the Ontario Breeding Bird Atlas’ *Breeding Evidence Codes* (Bird Studies Canada, 2019). The Alder Flycatcher, American Bittern, American Goldfinch, American Robin, Baltimore Oriole, Black-and-white Warbler, Black-billed Cuckoo, Black-capped Chickadee, Black-throated Green Warbler, Canada Goose, Chestnut-sided Warbler, Chipping Sparrow, Common Yellowthroat, Downy Woodpecker, Eastern Meadowlark, Eastern Phoebe, Eastern Towhee, Eastern Wood-pewee, Great Crested Flycatcher, Mourning Dove, Northern Cardinal, Northern Flicker, Purple Finch, Red-eyed Vireo, Ring-billed Gull, Rose-breasted Grosbeak, Savannah Sparrow, Song Sparrow, Sora, Swainson’s Thrush, Swamp Sparrow, Tree Swallow, Veery, Warbling Vireo, White-breasted Nuthatch, Wilson’s Snipe, Winter Wren, Wood Thrush, Yellow Warbler, Yellow-bellied Sapsucker, their nests, and eggs are protected under the MBCA. The Canada Goose and Ring-billed Gull were observed as flyovers and are not considered to be resident breeders within the study area. The Blue Jay and Wild Turkey are afforded protection under the *Fish and Wildlife Conservation Act* (1997) (FWCA). The American Crow, Common Grackle, European Starling, Red-winged Blackbird, and Rock Pigeon are not afforded protection under the MBCA or FWCA. Two (2) Common Grackle nests were observed within compost piles located in the western end of the mixed meadow (MEM) in the northern end of the study area during the May 24, 2019 field investigation. One nest contained five (5) unhatched eggs. The other nest contained a fledgling mortality.

A review of NHIC data identified a deer yard present within the Perth Long Swamp PSW (Town of Perth, 2017) not on the subject property. White-tailed deer tracks were observed throughout the study area during the field investigations.

4.0 DESCRIPTION OF THE PROPOSED PROJECT

The Phase 6 development within the study area is subject to a Draft Plan of Subdivision application. The proposed work for Phase 6 includes:

- Clearing of the majority of the subdivision area;
- Construction of residential roads within the cleared area, and
- Development within the cleared area.





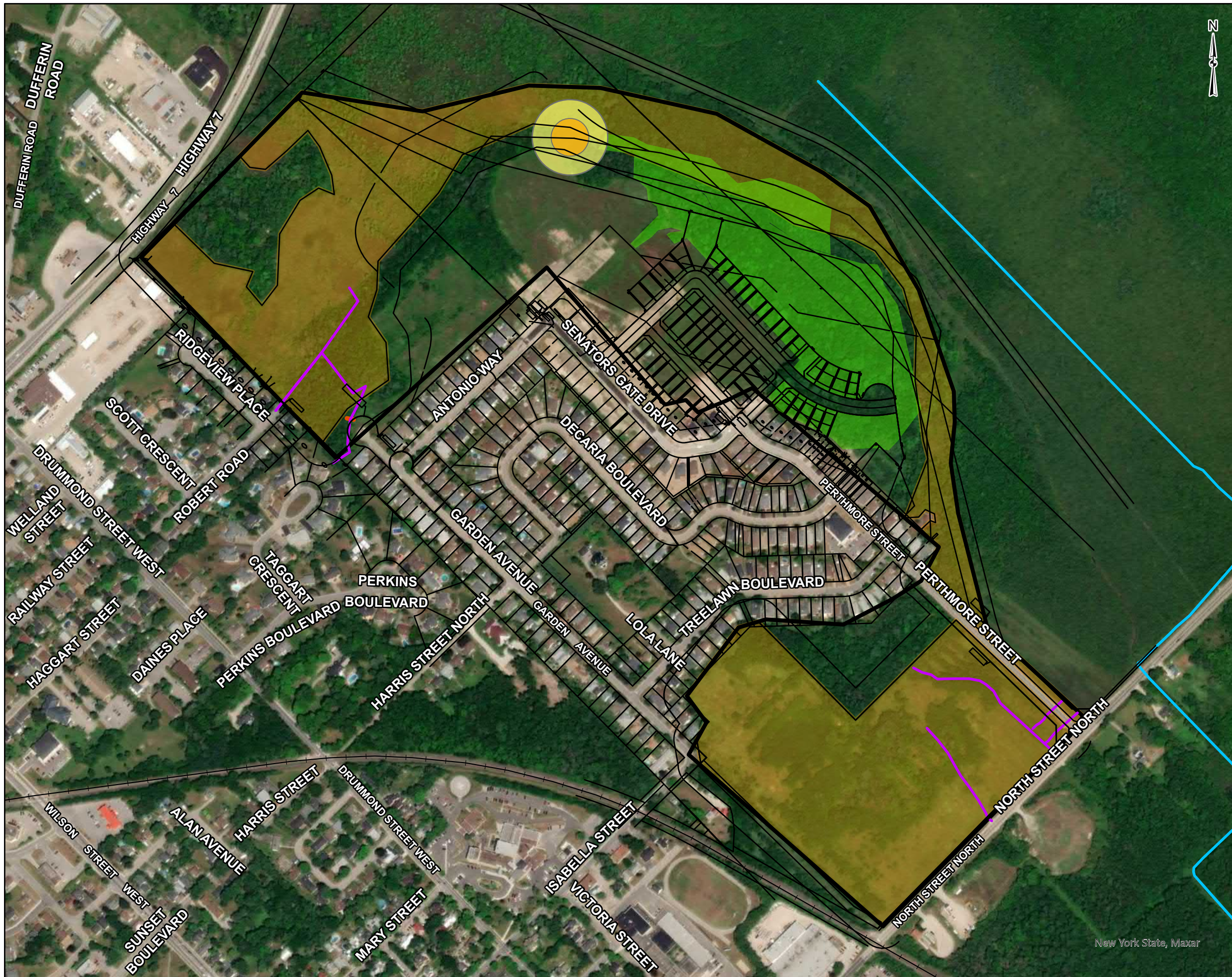

Refer to **Figure 5** for the Draft Plan of Subdivision for the proposed development area. The development will include clearing most of the vegetation within the Phase 6 limits as seen on Figure 5. This will occur adjacent to a 30 m buffer around the PSW. Residential roads will be constructed within the area to be cleared which will serve as access to potential development of single-detached dwellings and semi-detached dwellings.

The proposed project also includes a number of mitigation measures detailed within Section 6.0 herein, including but not limited to:

- Vegetation planting within the 30 m wetland buffer and associated with the stormwater pond habitat; and
- Educational materials for residents outlining the natural heritage features and the importance of conservation

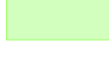

LEGEND

-  Perthmore Boundary
-  Beaver Dam
-  Ditch
-  Watercourse
-  McIntosh Perry Updated PSW Boundary within Study Area Limits
-  Significant Wildlife Habitat
-  25 m Butternut Buffer
-  50m Butternut Buffer

REFERENCE
 GIS data provided by the Ontario Ministry of Natural Resources and Forestry, 2022.

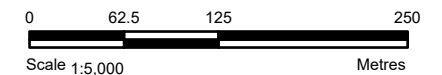

CLIENT:	PERTHMORE SUBDIVISION	
PROJECT:	EIS	
TITLE:	WETLAND RECLASSIFICATION MAPPING	
McINTOSH PERRY <small>115 Walgreen Road, RR3, Carp, ON K0A1L0 Tel: 613-836-2184 Fax: 613-836-3742 www.mcintoshperry.com</small>	PROJECT NO: PP-13-9668	FIGURE:
	Date	Jul., 15, 2022
	GIS	MG
	Checked By	JK
		5

New York State, Maxar

5.0 IMPACT ASSESSMENT

The following sections outline and assess any potential impacts that are expected as a result of the proposed development. Recommendations for mitigation measures to avoid these impacts are outlined in Section 6.0 of this report.

5.1 Natural Heritage System Components, Landforms, Soils, and Geology

The proposed work of Phase 6 will include clearing and development of the Mixed Meadow (MEM) in the center of the study area. No significant landforms, soils or geology are present or adjacent to this area. The FODM5-4, SWD1, and FOC vegetation communities (Figure 4) are considered to be 'Potentially Significant Woodlands' according to the *Town of Perth Official Plan* (Town of Perth, 2017). The proposed project is anticipated to remove less than 1.5 hectares of FODM5-4 which is a Dry-fresh Sugar Maple, Ironwood Deciduous Forest.

'Significant Wildlife Habitat' was identified within the Perth Long Swamp PSW and potentially in FODM5-4 based on the presence of species of special concern observed during field reviews. No valleylands were identified within the study area.

Official Plan section 8.6.4(e) addresses Significant Woodlands and Potentially Significant Woodlands, and generally establishes that an EIS is required before development can proceed within/adjacent to these areas. Official Plan policy 8.6.4(e)(3) reads as follows:

Where a potentially Significant Woodland feature corresponds to an area within the Environmental Protection designation on Schedule 'A' of this Plan then development or site alteration shall not be permitted unless an EIS is completed and demonstrates either that the identified feature is not a significant woodland or, where a Woodland is confirmed as significant, there will be no negative impacts to natural features or their ecological functions.

Only small portions of the stormwater management block are designated Environmental Protection on Schedule 'A' of the Official Plan, and this EIS is provided in order to address impact to natural features and their ecological functions.

5.2 Surface Water, Groundwater, Wetlands, and Fish Habitat

5.2.1 Wetlands

A significant portion of the study area (approximately 52 %) is comprised of the Perth Long Swamp PSW. The boundaries of this PSW were reclassified due to outdated modelling of the wetland boundaries. Approximately 0.61 ha of the previous boundary was removed from the study area. Approximately 9.28 ha were added to the study area. Most of the expansion occurred in the southeast end of the study area (**Figure 3**). Due to the presence of a PSW within the study area, a 30 m setback from the boundaries of the PSW is proposed to be established in which no clearing or development are to take place (see **Figure 5**). This setback was chosen based on recommendations in the Natural Heritage Reference Manual (MNDMNR, 2010) as well as observations during the field investigation in which non-sensitive vegetation communities and habitats were recorded adjacent to the PSW. It is anticipated that the 30 m forested buffer will remove a large amount of potential nutrient run-off. A

stormwater pond is proposed and surface water will be directed to this pond which will significantly reduce the risk of sedimentation to the wetland. Although the PSW does provide valuable wildlife function, it is not anticipated that any species at risk critical habitat is found adjacent to the subdivision area. No significant natural areas such as waterfowl staging areas or significant amphibian breeding ponds are found immediately adjacent the subdivision. The wetland itself is likely to provide function for SAR and breeding amphibians and will continue to provide this function. Breeding bird surveys were completed and there were no waterfowl nesting areas noted. Based on personal experience the wetland is likely to provide wintering habitat for wildlife species such as the Bobcat, however this function should not be affected by the proposed works.

The proposed vegetation clearing and Phase 6 development will occur in all of the upland areas including MEM, FODM5-4 and FODM7 vegetation communities. Based on Google Earth satellite imagery (Maxar Technologies, 2019), the MEM community was cleared prior to 2005 and regenerated with meadow conditions. Ecological functions of this area are limited due to the disturbance and cultural impacts of previous clearing. The adjacent woodlands (FODM5-4, FODM7) are at a higher elevation than the Mixed Meadow to the southwest and the deciduous swamp (SWD1) (as part of the PSW) to the northeast. No negative impacts to the PSW are anticipated as part of the clearing and development of the scheduled Phase 6 development plan. A stormwater management pond (proposed Block 55) will be incorporated as part of the subdivision and is proposed outside of the 30 m setback. As such, removal/alteration of these habitats will include upland habitat/vegetation removal a minimum of 30 m from the PSW. Drainage is proposed to be directed towards the Stormwater Management pond, following which it will outlet in a controlled manner farther southeast. The details are to be confirmed at the detailed design phase of approvals.

As such, it is recommended that no future lot-lines should extend within 30 m of the PSW on the property to prevent impacts to the wetland. At this location no vegetation removal should occur within the full 30 m buffer and where vegetation is currently disturbed and a planting plan should be prepared to provide appropriate protection and improvement to habitat. An exception to disturbance in this area could include a modest recreational pathway.

Per Section 8.6.4(b)(2) of the Town of Perth Official Plan, "Development and site alteration shall not be permitted in the Perth Long Swamp, the Blue Berry Creek Wetland, and the Grant's Creek Wetland. Development and site alteration shall not be permitted on adjacent lands to these significant wetlands unless it has been demonstrated, through the preparation of an Environmental Impact Study (EIS) as required in Section 8.5.4 e. EIS of this Plan, that there will be no negative impacts on the natural features or on the ecological functions for which a specific wetland area is identified. This shall include impacts on the wildlife habitat which exists in these wetlands."

As written in Section 5.1 above, this EIS is provided to address impact to natural features and their ecological functions.

Considering the existing landscape, the development of Phase 6 of this subdivision meets the no development within a provincially significant wetland requirements of the Perth OP and provincial documents. It can be determined that there would be no significant impacts to the PSW based on the current plan provided a 30 m buffer is maintained and where a buffer does not exist one is planted.

In the northern portion of the property, there is commonly a 30 m or less treed buffer between the wetland and the open MEM habitat. Retention of this forested portion and enhancing it along this northern portion of the lands within 30 m would provide a sufficient buffer and would be a positive impact to the Long Swamp PSW at this location.

5.2.2 Fish Habitat

The tributaries associated with the southeast end of the study area provide suitable spawning habitat for sport fish (i.e. Northern Pike) and baitfish. These habitats are seasonal as the water conditions fluctuate. The tributaries are within the PSW in the study. The proposed development is situated more than 30 m from the tributaries. It is not anticipated that the proposed development will have impacts on fish or fish habitat.

5.3 Vegetation Cover

5.3.1 Vegetation Communities

Vegetation removal is proposed to occur for a large portion of Phase 6 of the study area. The MEM vegetation community will be fully cleared where previous clearing has occurred (prior to 2005) and regeneration of pioneer graminoid species (i.e. grass) and non-native herbaceous species typical of roadsides (i.e. cow vetch, red clover, etc.) have established. Portions of the Dry-Fresh Sugar Maple-Ironwood Deciduous Forest (FODM5-4) are anticipated to be impacted by vegetation clearing and subsequent development of the property. FODM7 is not expected to be significantly impacted at this time by clearing activities. Less than 1.5 hectares of forested community is anticipated for removal as part of Phase 6. Due to the historical disturbance of the Mixed Meadow and the low diversity of native plants, it is not anticipated that significant negative impacts will occur to vegetation within this community. As mentioned above less than 1.5 hectares of Community FODM5-4 is anticipated to be removed as a result of the proposed Phase 6 works. This removal is anticipated to be primarily edge habitat. A parkland block is included in the plans for Phase 6 and it has been assumed that this area will remain as wildlife habitat.

Given the location of the development in close proximity to the Perth Long Swamp, educational signage is proposed as a feature within the park to educate the public about the significant habitats within and adjacent to the Town of Perth and their importance to the ecosystem.

Vegetation communities of this type are not rare within the landscape in Lanark County and it is not anticipated that the removal of this vegetation will impact this type of vegetation community in the broader landscape. It is proposed to off-set most or all of the loss of vegetation by planting within any under-vegetated areas within the proposed 30m-buffer adjacent to the Perth Long Swamp and within non-functional areas of the Stormwater Pond block as wildlife habitat where access is not required. Enhancing the wetland buffers and creating habitat associated with the stormwater pond is expected to off-set the loss of primarily fringe habitat proposed for removal.

5.3.2 SAR Vegetation

Two (2) Butternut trees were identified within the Coniferous Forest (FOC) and Dry-Fresh Sugar Maple-Ironwood Deciduous Forest (FODM5-4) of the PSW in the study area. The *Butternut Recovery Strategy* (MNRF, 2013)

recommends a 25 m buffer around ‘retainable’ trees do avoid damage to root zones and prevent shading due to the species’ intolerance to shade. An additional 25 m buffer is also recommended to preserve habitat around any ‘retainable’ for potential establishment of seedlings (**Figure 2**). At least 30 days prior to any vegetation clearing, these individuals must be assessed by a qualified Butternut Health Assessor into Categories 1, 2 or 3 as part of the requirements under Section 23.7 of Ontario Regulation (O. Reg.) 242/08 – *General* of the ESA. One of the butternuts has been assessed, however depending on the potential impact date, the tree and area should be cleared again if it is more than 3 years from the original assessment/area review. The following are definitions of the Butternut Categories during a health assessment under O. Reg. 242/08:

- Category 1 tree – “the butternut tree is affected by butternut canker to such an advanced degree that retaining the tree would not support the protection or recovery of butternut trees in the area in which the tree is located”;
- Category 2 tree – “the butternut is not affected by butternut canker, or the butternut tree is affected by butternut canker, but the degree to which it is affected is not too advanced and retaining the tree could support the protection or recovery of butternut trees in the area in which the tree is located”, and
- Category 3 tree – “the butternut tree may be useful in determining sources of resistance to butternut canker”.

A *Butternut Health Assessment Report* (**Appendix C**) was prepared by a qualified Butternut Health Assessor (BHA) which assessed the conditions of the Butternut tree found in the Dry-Fresh Sugar Maple-Ironwood Deciduous Forest (FODM5-4) in the east end of the study area. The tree was deemed as Category 2 (retainable). The assessment was conducted on June 22, 2019 and the report was submitted to the MECP on August 30, 2019. As of the timing of this EIS, the mandatory 30-day period has finished. Development adjacent to the assessed Butternut should occur outside of the 50 m buffer around the individual. It is not anticipated that impacts will occur to the Butternut present within the study area due to the limits of the proposed development, however future development of the by-pass road may impact this individual tree.

The Butternut tree in the Coniferous Forest (FOC) in the west end of the study area has not been assessed as of the timing of this EIS. No other at-risk vegetation was observed within the study area. It is not anticipated that the Butternuts present within the study area will be harmed or removed as part of the proposed works.

Butternut can spread to open areas and therefore additional trees can grow as Phase 6 of the subdivision develops. As such, it is recommended that a butternut survey be completed prior to development of Phase 6 of the development.

5.4 Habitat for Species at Risk & Significant Wildlife Habitat

Due to their status of ‘Special Concern,’ habitat for the Eastern Wood-pewee and Wood Thrush is considered Significant Wildlife Habitat in accordance with the Natural Heritage Reference Manual. Less than 1.5 hectares of vegetation clearing is proposed within their habitat identified in **Figure 2**. Although there will be the direct loss of usable breeding habitat for both species, there is no shortage of suitable habitat within Lanark County, including within the immediate vicinity, and it is not anticipated that either species will be negatively impacted within the County as part of the loss of habitat in the proposed Phase 6 development. This area represented one potential

nesting pair of each species in 2019. The function of this woodland will be partially impaired, however the individuals represented will continue to find habitat available in the remaining upland habitat and/or easily find suitable habitat throughout the area. Eastern Wood-pewee and Wood Thrush nests and eggs are afforded protection under the MBCA and cannot be harmed, harassed, or killed as a result of development activities, and these requirements are reflected in the Sections 6.5 and 6.6 of this EIS.

Policy 8.6.4(b)(2) of the Official Plan states in part that “Development and site alteration shall not be permitted in significant wildlife habitat,” and that “Development and site alteration shall not be permitted on adjacent lands to these natural heritage features unless it has been demonstrated through the preparation of an EIS as required in Section 8.5.4 e.~ EIS of this Plan, that there will be no negative impacts on the natural features or on their ecological functions.”

According to the Natural Heritage Reference Manual (NHRM) (2005) ‘Development and site alteration shall not be permitted in: d) significant wildlife habitat; unless it has been demonstrated that there will be no negative impacts on the natural features or their ecological functions.

The proposed development includes some development and alteration of significant wildlife habitat, but in an area that is almost entirely separate from that designated Environmental Protection Area - Natural Heritage Features on Schedule “A” of the Official Plan. Accordingly, when considering mitigation measures proposed, the intent of the Official Plan policy is adhered to.

As previously discussed, there is a large amount of this type of forest and forest habitat in general that remains and will remain that these two species are able to use. Neither of these species is rare within the broader study area as they are observed throughout the County based on our extensive knowledge of the area. Additionally, the proposed/future Perth by-pass road, if or when it is constructed, is expected to fragment this forested area and isolate the habitat between the subdivision and by-pass roadway. Accordingly, it is anticipated that the by-pass road is likely to eliminate the use of the habitat by the Wood Thrush. The Eastern Wood-pewee may continue to find habitat within the remaining forested after the by-pass is installed as they are adapted to smaller forested areas, however their continued use can’t be certain. The Town of Perth is a designated settlement area, the large majority of the subject lands are designated under the Official Plan for residential development, and further to Section 1.1.3 of the PPS, settlement areas shall be the focus of growth and development. Section 1.1.3 also provides that land use patterns within settlement areas shall be based on densities and a mix of land uses which efficiently use land and resources. Given the eventual development of the arterial road and policy support for development within settlement areas, it is our opinion that the proposal (including the recommendations of the EIS) satisfies the intent of all applicable policies, including those intending to protect significant wildlife habitat and associated SAR and other species. The enhancements discussed above in Section 5.3 are anticipated to offset significant wildlife habitat impacts by buffering the PSW with upland vegetation and an increased buffer from the wetland in the vicinity of the stormwater pond, constructed in such a way as to enhance habitat.

5.5 Wildlife

A total of 38 species of migratory birds and seven (7) non-migratory birds were observed to be possible breeders within the study area during the 2019 field investigations (**Table 4**). Therefore, if construction (including any

vegetation removal) is proposed from April 15 to September 15 (Hussel and Lepage, 2015), of any year, the area where clearing is proposed to occur, must be screened by an avian specialist prior to construction activity. This is recommended in order to prevent negative impacts to migratory birds and other bird species (especially those that are known to nest within recently cleared areas, such as the Killdeer), their nests and eggs, which are protected under the MBCA or the FWCA.

The white-tailed deer is a highly mobile species which travels for extended periods of time in search of food. There were no deer yards observed within the study area (however, deer tracks were observed) which suggests that this species does not rely significantly on the area proposed for clearing. No development is proposed to occur within the Perth Long Swamp PSW where a deer yard has been identified. The North American beaver is an amphibious species which spends most of its life in water. A small beaver dam was observed in a ditch line in the north west end of the study area. Impacts to the ditch lines and dam within the study area are not anticipated as part of the Phase 6 development as they are not located within the proposed area for clearing. Significant negative impacts are not anticipated to wildlife habitat as a result of the proposed development.

5.6 Significant Woodlands

Schedule 11 to the Perth OP identifies areas of potentially significant woodlands. This includes Community FODM5-4 and SWD-1 within the vicinity of Phase 6 of the proposed plan. The Town of Perth Official Plan (2019), defines Significant Woodlands as "...areas which serve an important ecological function in the broader landscape because of their location, extent of forest cover, tree age and long-standing forest function, species composition and their potential as wildlife habitat". Using the criteria in the NHRM (2005) SWD-1 does not classify as a woodland as it is primarily a shrub swamp with some younger water tolerant trees around the periphery adjacent to FODM5-4. Community FODM5-4 generally does not meet the criteria of a significant woodland within the broader study area as it does not meet size thresholds, does not meet interior forest cover size, does not provide a significant link, and is a common vegetation community throughout the landscape that does not have significant vegetation species. McIntosh Perry is unaware of any economic and social values of the woodland. The trees within the forest could be considered mature, however this does not imply woodland significance within the area. However, the proximity of the woodland to a significant feature (within 30m of Perth Long Swamp) would classify it as a significant woodland. The Perth OP also includes potential as wildlife habitat as a contributor to significant woodlands. The woodland is considered significant wildlife habitat which was addressed in Section 5.4.

According to policy Section 8.6.4(e) of the Official Plan, no development is generally to be permitted within significant woodlands "...unless and EIS is completed and demonstrates either that the identified feature is not a significant woodland or, where a Woodland is confirmed as significant, there will be no negative impacts to natural features or their ecological functions."

As explored within Section 5.5 above, the proposed development (including the recommendations of the EIS) satisfies the intent of applicable Official Plan policies, including those intending to protect significant woodlands.

The development currently is planned to remove less than 1.5 hectares of the potentially significant woodland. The loss of woodland habitat for Phase 6 will primarily be edge habitat allowing the significant woodland to remain and wildlife to continue to utilize it in the same function as before. It will also continue to function for the reason

it was determined to be significant woodlands which is buffering the Perth Long Swamp. The main reason for it being categorized as Significant Woodland (within 30 m of a significant feature) is likely to be impacted in the future based on plans for an arterial bypass. Therefore, looking at future conditions it is doubtful that the woodland will continue to meet the significant woodland criteria for being adjacent to a significant natural feature. Any water contributions from the woodland to the PSW can be mitigated in the design of the subdivision.

5.7 Wildland Fire Risk Assessment

According to Section 3.1.8 of the *Provincial Policy Statement, 2014*, “Development shall generally be directed to areas outside of lands that are unsafe for development due to the presence of hazardous forest types for wildland fire. Development may, however, be permitted in lands with hazardous forest types for wildland fire where the risk is mitigated in accordance with wildland fire assessment and mitigation standards.”

Wildland fire assessment is necessary to determine the presence or absence of forest types associated with the risk of high to extreme wildland fire. Recommended mitigation techniques are designed to disrupt that principle of combustion by eliminating one or more of the three necessary elements of fire (heat, oxygen and fuel). They do so by minimizing the opportunity for ignition of new fires from embers; reducing the potential for direct flame contact from approaching wildland fires; and reducing the effects of radiant heat from an approaching wildland fire by reducing the opportunity for crown fire potential (MNDMNRF, 2016).

The woody species composition (refer to Section 3.5), condition (i.e. very few coniferous trees on the restricted to the northwest end of the study area adjacent to the PSW, scattered eastern white-cedars in low-lying wet areas, etc.), and health (i.e. low occurrence of insect or diseased trees), within 100 m of the proposed development, characterizes the adjacent wooded area as not a hazardous forest type. Therefore, further risk assessment and mitigation measures are not required.

6.0 RECOMMENDED MITIGATION MEASURES

To minimize or eliminate environmental impacts and to help achieve ecological and environmental improvements from the proposed construction and development, the following mitigation measures are recommended.

6.1 Natural Heritage System Components

- No development or vegetation clearing shall occur within 30 m of the Perth Long Swamp PSW, significant woodlands or significant wildlife habitat as part of the Phase 6 proposed development unless identified as part of the subdivision plan for Phase 6.
- Educational signs and other materials are to be provided for the future park lands (Block 58) which are within and adjacent to natural features.

6.2 Surface Water, Groundwater, Wetlands, and Fish Habitat

- During construction, the Contractor should have a spill kit on-hand at all times, in case of spills, and
- No development shall occur within the undisturbed Perth Long Swamp PSW (and subsequent tributaries of Tay River).

6.3 Vegetation Communities

- It is recommended that only locally appropriate native species be used for landscaping within the subject property. This would contribute to re-establishing native plants within the wider landscape and potentially have a positive impact for biodiversity (i.e., using native species for pollinators such as bees);
- Where vegetation is not currently present within 30 m of the Perth Long Swamp a plan should be prepared to enhance this buffer. This should occur primarily at the north end of the developable lands.
- The proposed stormwater pond (Block 55) is to be vegetated to allow the habitat to be utilized by wildlife from adjacent communities. Details are to be confirmed at the detailed design phase of approvals.
- To prevent the introduction and spread of invasive plant species into the site, equipment utilized during construction should be inspected and cleaned in accordance with the *Clean Equipment Protocol for Industry (Appendix B)*;
- As part of the proposed works, the following mitigation measures should be implemented to prevent harm to trees adjacent to the area of proposed development:
 - Protect trees and their roots (within the buffer limits) from damage, compaction, and compensation resulting from construction;
 - Do not place material or equipment on bare roots of the protected trees;
 - Do not attach any signs or notices to protected trees to prevent mechanical damage to the tree;
 - Do not damage the root system, trunk or branches of any protected trees, and
 - Ensure that exhaust fumes from all equipment are not directed towards the canopy of the protected trees.

6.4 SAR Vegetation

- If the Butternut tree assessed as a Category 2 Butternut in the east end of the study area is proposed to

be harmed or removed or if development is to occur within the 50 m buffer around the tree, the following steps must be followed under the Ontario Regulation (O. Reg.) 242/08 – *General* to comply with the ESA:

- “4. If the butternut health assessor’s report indicates that one or more of the butternut trees are category 2 trees, the person must satisfy the following additional conditions with respect to those trees after the 30-day period described in paragraph 3 has elapsed:
 - i. before killing, harming or taking the category 2 trees, the person must give the Minister notice of the activity by submitting a notice of butternut impact form available on the Registry to the Minister through the Registry,
 - ii. the person must ensure that the notice of butternut impact form includes,
 - A. the number of category 2 trees that the person proposes to kill, harm or take,
 - B. whether the category 2 trees will be killed, harmed or taken,
 - C. the location of each category 2 tree and the diameter of each tree at breast height, and
 - D. the date and report number of the butternut health assessor’s report prepared in respect of the butternut trees in question,
 - iii. the person must follow the requirements of subsections (7) and (8) with respect to the completion of the notice of butternut impact form, the keeping of records relating to the notice of butternut impact form and the updating of the information on the Registry, and
 - iv. the person must comply with the requirements set out in subsection (10) for planting seedlings to replace butternut trees that are killed, harmed or taken and for monitoring and tending to those seedlings, and keeping records in relation to the seedlings. O. Reg. 176/13, s. 14”;
- (7) Before submitting a notice of butternut impact form to the Minister, the person must ensure that,
 - (a) all mandatory information requested on the form, including the person’s contact information, has been provided; and
 - (b) the information provided on the form is complete and accurate. O. Reg. 176/13, s. 14.
- (8) After submitting a notice of butternut impact form to the Minister, the person must,
 - (a) promptly upon obtaining from the Ministry confirmation that a notice of butternut impact form submitted through the Registry has been received by the Minister, make a record of the confirmation;
 - (b) for as long as the activity is being carried out,
 - (i) keep the record of the confirmation and, if applicable, ensure that a copy of the record is kept at the site where the activity is being carried out, and
 - (ii) make the record of the confirmation available to the Ministry upon receiving a request for it; and
 - (c) if there is a change in the contact information for the person who submitted the notice of butternut impact form, update the information on the Registry within 10 business days of the change. O. Reg. 176/13, s. 14.
- (10) A person who kills, harms or takes one or more butternut trees that are category 2 trees and who, pursuant to subsection (4), is exempt from clause 9 (1) (a) of the Act shall comply with the following requirements:
 - 1. For each tree that is killed or taken, the person shall plant butternut seedlings in accordance with the following rules:

- *i. at least two butternut seedlings, if the tree that is killed or taken is described in the butternut health assessor's report as shorter than breast height or less than three centimetres in diameter at breast height,*
- *ii. at least five butternut seedlings, if the tree that is killed or taken is described in the butternut health assessor's report as at least three centimetres but less than 15 centimetres in diameter at breast height, and*
- *iii. at least 20 butternut seedlings, if the tree that is killed or taken is described in the butternut health assessor's report as 15 centimetres or greater in diameter at breast height.*
- *2. For each tree that is harmed, the person shall plant butternut seedlings in accordance with the following rules:*
 - *i. at least one butternut seedling, if the tree that is harmed is described in the butternut health assessor's report as shorter than breast height or less than three centimetres in diameter at breast height,*
 - *ii. at least three butternut seedlings, if the tree that is harmed is described in the butternut health assessor's report as at least three centimetres but less than 15 centimetres in diameter at breast height, and*
 - *iii. at least 10 butternut seedlings, if the tree that is harmed is described in the butternut health assessor's report as 15 centimetres or greater in diameter at breast height.*
- *3. Every butternut seedling that is planted must have been grown from seed that originated from the seed zone in which it is planted.*
- *4. All butternut seedlings must be planted within three years of the person submitting the relevant notice of butternut impact form under subparagraph 4 i of subsection (4).*
- *5. Butternut seedlings must be planted in an area with the following characteristics:*
 - *i. the soil must be greater than one metre deep, moist but well-drained and have a fine to medium texture with a recognizable organic layer and with a pH ranging from 6.8 to 7.2, and*
 - *ii. the area must provide full sunlight conditions to the butternut seedlings.*
- *6. In order to avoid a monoculture of butternut, the person shall plant deciduous trees and shrubs that are not butternut seedlings and that are native to the area in which the seedlings are planted in such numbers to ensure that there are an equal number of butternut trees and other native Ontario species in the area.*
- *7. Every butternut seedling and companion tree or shrub referred to in paragraph 6 must be planted either between March 1 and May 15 or between September 20 and October 30 of any year, except for a butternut seedling or companion tree or shrub that was grown in a container which may be planted between May 16 and May 25 of any year.*
- *8. No more than 200 butternut seedlings shall be planted in a hectare.*
- *9. Butternut seedlings must be planted at least,*
 - *i. three metres from other planted butternut seedlings,*
 - *ii. two metres from other trees or shrubs that are likely to be the same height or shorter than the butternut tree at full growth,*
 - *iii. four metres from other trees or shrubs that are likely to be taller than the butternut tree at full growth,*

- *iv. five metres from the canopy drip line of trees that are greater than four metres in heights at the time of planting, and*
- *v. 100 metres from a highway consisting of two or more lanes in either direction.*
- *10. Every butternut seedling that is planted under this subsection must be monitored once annually between May 15 and September 20 for two years after it is planted to assess the health of the tree and its habitat conditions.*
- *11. In order to ensure the good growth and health of the butternut tree, every butternut seedling that is planted under this subsection must be tended to in accordance with the following rules:*
 - *i. tending activities shall take place once a week from May 15 to September 20 during the first growing season after the butternut seedling is planted,*
 - *ii. tending activities during the first growing season after the butternut seedling is planted will include,*
 - *A. maintenance of tree guards to protect the lower stem from rodents,*
 - *B. vegetation control 60 centimetres around the base of the tree until the tree is above the herbaceous vegetation, and*
 - *C. watering during drought or low rainfall periods, and*
 - *iii. tending activities shall take place during the second growing season after the butternut seedling is planted as required to ensure that,*
 - *A. vegetation is controlled 60 centimetres around the base of the tree until the tree is above the herbaceous vegetation, and*
 - *B. the tree is watered during drought or low rainfall periods.*
- *12. The person must plant a butternut seedling to replace any butternut seedling planted under this subsection that dies within two years of the planting of the seedling and must do so in accordance with the planting requirements of this subsection.*
- *13. For each butternut seedling planted under this subsection, the person must maintain a record of the planting, monitoring and tending activities required under this subsection, which record shall include,*
 - *i. the date the butternut seedling was planted,*
 - *ii. the date of each time a person attended to monitor or tend to the butternut tree,*
 - *iii. a description of every monitoring and tending activity,*
 - *iv. an assessment of the health status of the butternut seedling every time it is monitored or tended to to indicate if its health is good, poor or whether it is dead, and*
 - *v. whether the butternut tree shows evidence of butternut canker and, if so, a description of the extent to which the tree is affected by butternut canker.*
- *14. Within 14 days of receiving a request from the Ministry, the person shall provide the record maintained under paragraph 13. O. Reg. 176/13, s. 14; O. Reg. 323/13, s. 4.*
- Due to the Butternut tree identified in the west end of the study area, a Butternut Health Assessment must be conducted by a qualified Butternut Health Assessor if any works are proposed to occur within 50 m of the tree. The assessment must be conducted, and a report submitted to MECP at least 30 days prior to any vegetation clearing that would impact the Butternut. The assessment must follow the steps outlined in Section 23.7 of O. Reg. 242/08.

6.5 Habitat for Species at Risk and Significant Wildlife Habitat

- Eastern Wood-pewee and Wood Thrush (SAR) were observed in the forest within the study area. The clearing of this habitat should be done so at an appropriate time of year to not disturb these species;
- Butternut habitat has been defined as a 50 m radius around each individual tree in which no development or work activities shall occur without further communication with MECP or approval from a Butternut Health Assessor. Mitigation measures listed in Section 6.3 may also apply to Butternuts however it is not anticipated to have any impact for Phase 6 of the project; and
- Should any SAR be discovered during construction, a management biologist at MECP – Kemptville District should be contacted immediately, and operations modified to avoid any negative impacts to SAR or their habitat until further direction is provided by MECP.

6.6 Wildlife

- To prevent harming, harassing or killing migratory birds, no clearing or other construction should occur from April 15 to September 15, unless a qualified biologist has determined that no nesting is occurring within 5 days prior to the clearing. Note: these dates are based upon breeding bird nesting data for eastern Ontario, provided by Environment Canada. The nests and eggs of many bird species are protected under federal and/or provincial legislation (i.e. MBCA, FWCA), and
- Thickets or woodlands should not be removed during sensitive times of year (i.e. March through mid-August for the breeding season, Mid-October through March for overwintering wildlife). The *Canadian Wildlife Service does not support relying on inspections for migratory bird nests in such habitats due to the difficulty of locating all nests and risk to birds.*

7.0 SUMMARY

This EIS has been prepared to review the development area proposed for Phase 6 on Perthmore Road, “Part Lots 3 and 4, Concession 2, Geographic Township of Drummond.”

This EIS has assessed the existing land use and determined the potential impacts to the natural heritage features (i.e. PSW, Significant Woodland, unevaluated wetland, Significant Wildlife Habitat, etc.), as well as SAR and SAR habitat as a result of the proposed development. Although the development does impact natural heritage features, adherence to the proposed recommendations and mitigation measures provided in Sections 5.0 and 6.0 of this report will ensure that the intent of applicable natural heritage policies are satisfied.

On a larger landscape scale, the proposed alterations are generally not anticipated to have a significant impact on the ecological function. A Provincially Significant Wetland setback reduction from 120 m to 30 m is proposed, as it has been determined that there will be no significant impacts to the function of the Perth Long Swamp provided that the 30 m setback is either left natural/forested, or and where there is no significant vegetation within 30 m of wetland habitat, that this area be vegetated with native species pursuant to a future planting plan.

The Town of Perth is a designated settlement area, and the large majority of the subject lands are designated for development under the Perth Official Plan. Further to Sections 1.1.3 of the PPS, settlement areas shall be the focus of growth and development and land use patterns within settlement areas shall be based on densities and a mix of land uses which efficiently use land and resources. It is our opinion that the proposal satisfies the intent of applicable policy.

8.0 LIMITATIONS

The investigations undertaken by McIntosh Perry with respect to this report and any conclusions or recommendations made in this report reflect McIntosh Perry's judgment based on the site conditions observed at the time of the site inspection(s) on the date(s) set out in this report and on information available at the time of the preparation of this report.

This report has been prepared for specific application to this site, and it is based, in part, upon visual observation of the site and terrestrial investigations at various locations during a specific time interval, as described in this report. Unless otherwise stated, the findings cannot be extended to previous or future site conditions, or portions of the site which were unavailable for direct investigation.

If site conditions or applicable standards change or if any additional information becomes available at a future date, modifications to the findings, conclusions, and recommendations in this report may be necessary.

If you have any question, comments, or concerns, please do not hesitate to contact the undersigned at McIntosh Perry at 613-903-6147.

Sincerely,
McIntosh Perry Consulting Engineers Ltd.



Erik Pohanka, B. Sc.
Biologist

9.0 REFERENCES

- Bird Studies Canada, Environment Canada's Canadian Wildlife Service, Ontario Nature, Ontario Field Ornithologists, and Ontario Ministry of Natural Resources (OBBA). 2019. *Breeding Evidence Codes*. Ontario Breeding Bird Atlas Website. <https://www.bsc-eoc.org/dataentry/codes.jsp?page=breeding>. Accessed 06 November 2019.
- Bird Studies Canada, Environment Canada's Canadian Wildlife Service, Ontario Nature, Ontario Field Ornithologists, and Ontario Ministry of Natural Resources (OBBA). 2006. *Atlas Data Summary*. Ontario Breeding Bird Atlas Website. 31 January 2008. <http://www.birdsontario.org/atlas/index.jsp>. Accessed 06 November 2019.
- Canada Department of Agriculture. 1966. *Soils Map of Lanark County Ontario*. Soil Report No. 40. South Sheet. Map Reproduction Centre, Reproduction and Distribution Division, Department of Energy, Mines and Resources, Ottawa. <http://sis.agr.gc.ca/cansis/publications/surveys/on/on40/index.html>. Accessed 06 November 2019.
- Crins, W.J., P.A. Gray, P.W.C. Uhlig, and M.C. Wester. 2009. *The Ecosystems of Ontario, Part 1: Ecozones and Ecoregions*. Inventory, Monitoring and Assessment Section. Science and Information Branch. Ontario Ministry of Natural Resources. Ontario, Canada: Queen's Printer for Ontario. 87p.
- Ecological Stratification Working Group. 1996. *A National Ecological Framework for Canada*. Agriculture and Agri-Food Canada, Research Branch, Centre for Land and Biological Resources Research, and Environment Canada. State of the Environment Directorate; Ecozone Analysis Branch, Ottawa/Hull.
- Endangered Species Act*. 2007. S.O. 2007, c. 6. Current version 01 July 2019.
- Fish and Wildlife Conservation Act*. 1997. S.O. 1997, c. 41. Current version 26 March 2019.
- Hussell, J. and D. Lepage. 2015. *Bird Nesting Calendar Query Tool*. Project NestWatch. Bird Studies Canada. <http://www.birdscanada.org/volunteer/pnw/rnest/warning.jsp?lang=en>. Accessed 06 November 2019.
- Lee, HT, WD Bakowsky, J Riley, J Bowles, M Puddister, P Uhlig and S McMurray. 1998. *Ecological Land Classification for Southern Ontario: First Approximation and its Application*. Ontario Ministry of Natural Resources, South Central Science Section, Science Development and Transfer Branch. SCSS Field Guide FG-02.
- Maxar Technologies. 2019. *Google Earth Image*. Google Earth Pro. <http://www.earth.google.com>. Accessed 06 November 2019.
- Migratory Birds Convention Act*. 1994. S.C. 1994, c. 22. Current version 28 August 2019.
- Ministry of Municipal Affairs and Housing. 2014. *Provincial Policy Statement*. Queen's Printer of Ontario. 50 p.
- Ministry of Natural Resources and Forestry (MNRF). March 2010. *Natural Heritage Reference Manual for Natural Heritage Policies of the Provincial Policy Statement, 2005. Second Edition*. Toronto: Queen's Printer for Ontario. 248 p.
- Ministry of Natural Resources and Forestry (MNRF). 2013. *Butternut Recovery Strategy*. Queen's Printer of

Ontario. 55 p.

Ministry of Natural Resources and Forestry (MNRF). 2018. *Land Information Ontario metadata tool*. <https://www.ontario.ca/page/land-information-ontario>. Queen's Printer of Ontario. Accessed 06 November 2019.

Ministry of Natural Resources and Forestry (MNRF). 2019a. *Make A Map: Natural Heritage Areas*. Ministry of Natural Resources and Forestry. http://www.gisapplication.lrc.gov.on.ca/mamnh/Index.html?site=MNR_NHLUPS_NaturalHeritage&viewer=NaturalHeritage&locale=en-US. Queen's Printer for Ontario. Accessed 06 November 2019.

Ministry of Natural Resources and Forestry (MNDMNRF). 2019b. *Land Information Ontario (LIO)*. Queen's Printer for Ontario. <https://geohub.lio.gov.on.ca/>. Accessed 06 November 2019.

Ministry of Natural Resources and Forestry. 2016. *Wildland Fire Risk Assessment and Mitigation: A Guidebook in Support of the Provincial Policy Statement, 2014 – Draft*. Ministry of Natural Resources and Forestry. 78 p.

Ontario Geological Survey. 2010. *Surficial geology of Southern Ontario*. Ontario Geological Survey. http://www.geologyontario.mndm.gov.on.ca/mndmaccess/mndm_dir.asp?type=pub&id=MRD128-REV. Accessed 06 November 2019.

Ontario Nature. 2019. *Ontario Reptile and Amphibian Atlas: A citizen science project to map the distribution of Ontario's reptiles and amphibians*. Ontario Nature. <http://www.ontarionature.org/atlas>. Accessed 06 November 2019.

Rideau Valley Conservation Authority (RVCA). 2017. *Tay River Subwatershed Report 2017*. Rideau Valley Conservation Authority. <https://watersheds.rvca.ca/subwatersheds/tay-river/subwatershed-report-tay-river>. Accessed 06 November 2019.

Species at Risk Act. 2002. S.C. 2002, c. 29. Current version 28 August 2019.

Town of Perth. 2019. *Town of Perth Official Plan*. Town of Perth.

Tunnock Consulting Ltd. 2015. *Town of Perth Official Plan – Schedule A Land Use Designations and Overlays per Comprehensive Update Amendment No. 14*. Town of Perth. https://www.perth.ca/uploads/1169/Doc_636373547346580773.pdf?ts=637086360115268633. Accessed 06 November 2019.

APPENDIX A: SITE PHOTOGRAPHS



Photo 1: Mixed Meadow (MEM) vegetation community in the centre of the study area. 17 June 2019.



Photo 2: American Robin (*Turdus migratorius*) observed within the Mixed Meadow (MEM) vegetation community in the centre of the study area. 24 May 2019.



Photo 3: Mixed Meadow (MEM) vegetation community in the west end of the study area. 17 June 2019.



Photo 4: Common Grackle (*Quiscalus quiscula*) nest in compost pile in Mixed Meadow (MEM) vegetation community in the west end of the study area. 24 May 2019.



Photo 5: MEM Community extended into the forested area based on site visit on 15 July 2022.



Photo 6: Ditch line along the Mixed Meadow (MEM) and Green Ash Organic Deciduous Swamp (SWDO1-2) in the west end of the study area. 24 May 2019.



Photo 7: Small beaver dam observed in the ditch lines in the west end of the study area. 24 May 2019.



Photo 8: Green Ash Organic Deciduous Swamp (SWDO1-2) vegetation community within the west end of the study area in the PSW boundaries. 22 June 2019.



Photo 9: Beaver chew observed within the Green Ash Organic Deciduous Swamp (SWDO1-2) in the west end of the study area. 24 May 2019.



Photo 10: White-tailed deer (*Odocoileus virginianus*) tracks observed within the Green Ash Organic Deciduous Swamp (SWDO1-2) in the west end of the study area. 24 May 2019.



Photo 11: Eastern gray squirrel (*Sciurus carolinensis*) observed within the Green Ash Organic Deciduous Swamp (SWDO1-2) in the west end of the study area. 24 May 2019.



Photo 12: Eastern cottontail (*Sylvilagus floridanus*) observed within the Green Ash Organic Deciduous Swamp (SWDO1-2) in the west end of the study area. 24 May 2019.



Photo 13: Cattail Shallow Marsh (MASO1-1) vegetation community within the southeast end of the study area in the PSW boundaries. 08 June 2019.



Photo 14: Coniferous Forest (FOC) vegetation community within the northwest end of the study area. 17 June 2019.



Photo 15: Butternut (*Juglans cinerea*) observed within Coniferous Forest (FOC) vegetation community in the northwest end of the study area. 22 June 2019.



Photo 16: Shallow Marsh (MAS) vegetation community within the northwest end of the study area in the PSW boundaries. 17 June 2019.



Photo 17: Fresh-Moist Lowland Deciduous Forest (FODM7) vegetation community within the northwest end of the study area. 24 May 2019.



Photo 18: Fresh-Moist Lowland Deciduous Forest (FODM7) vegetation community within the southeast end of the study area. 24 May 2019.



Photo 19: Groundhog (*Marmota monax*) dens observed in the slopes of Perthmore Street. 24 May 2019.



Photo 20: Dry-Fresh Sugar Maple-Ironwood Deciduous Forest (FODM5-4) vegetation community within the east end of the study area. 24 May 2019.



Photo 21: Great Crested Flycatcher (*Myiarchus crinitus*) observed within the Dry-Fresh Sugar Maple-Ironwood Deciduous Forest (FODM5-4) vegetation community within the east end of the study area. 24 May 2019.



Photo 22: Eastern chipmunk (*Tamias striatus*) observed within the Dry-Fresh Sugar Maple-Ironwood Deciduous Forest (FODM5-4) vegetation community within the east end of the study area. 24 May 2019.



Photo 23: Butternut (*Juglans cinerea*) observed within the Dry-Fresh Sugar Maple-Ironwood Deciduous Forest (FODM5-4) vegetation community in the east end of the study area. 17 June 2019.



Photo 24: Ash Mineral Deciduous Swamp (SWD1) vegetation community within the east end of the study area. 17 June 2019.



Photo 25: Ash Mineral Deciduous Swamp (SWD1) vegetation community within the east end of the study area in the PSW. 24 May 2019.



Photo 26: Groundwater upwelling observed within the Ash Mineral Deciduous Swamp (SWD1) vegetation community in the east end of the study area. 24 May 2019.



Photo 27: Watercress (*Nasturtium officinale*) observed within the Ash Mineral Deciduous Swamp (SWD1) vegetation community in the east end of the study area. 24 May 2019.



Photo 28: Veery (*Catharus fuscescens*) observed within the Ash Mineral Deciduous Swamp (SWD1) vegetation community in the east end of the study area. 24 May 2019.



Photo 29: Willow Organic Deciduous Thicket Swamp (SWTO2) vegetation community within the southeast end of the study area. 17 June 2019.



Photo 30: Culvert outlet on Perthmore Street within the Willow Organic Deciduous Thicket Swamp (SWTO2) vegetation community in the southeast end of the study area. 24 May 2019.



Photo 31: Pileated Woodpecker (*Dryocopus pileatus*) observed within the Willow Organic Deciduous Thicket Swamp (SWTO2) vegetation community in the southeast end of the study area. 24 May 2019.



Photo 32: Willow Organic Deciduous Thicket Swamp (SWTO2) vegetation community within the southeast end of the study area. 17 June 2019.



Photo 33: Common Yellowthroat (*Geothlypis trichas*) observed within the Willow Organic Deciduous Thicket Swamp (SWTO2) vegetation community in the southeast end of the study area. 24 May 2019.



Photo 34: Cattail Graminoid Organic Meadow Marsh (MAMO1-2) vegetation community within the southeast end of the study area. 17 June 2019.



Photo 35: Culvert inlet on North Street conveying a tributary of Tay River within the Cattail Graminoid Organic Meadow Marsh (MAMO1-2) vegetation community in the southeast end of the study area. 24 May 2019.



Photo 36: Song Sparrow (*Melospiza melodia*) observed within the Cattail Graminoid Organic Meadow Marsh (MAMO1-2) vegetation community in the southeast end of the study area. 24 May 2019.

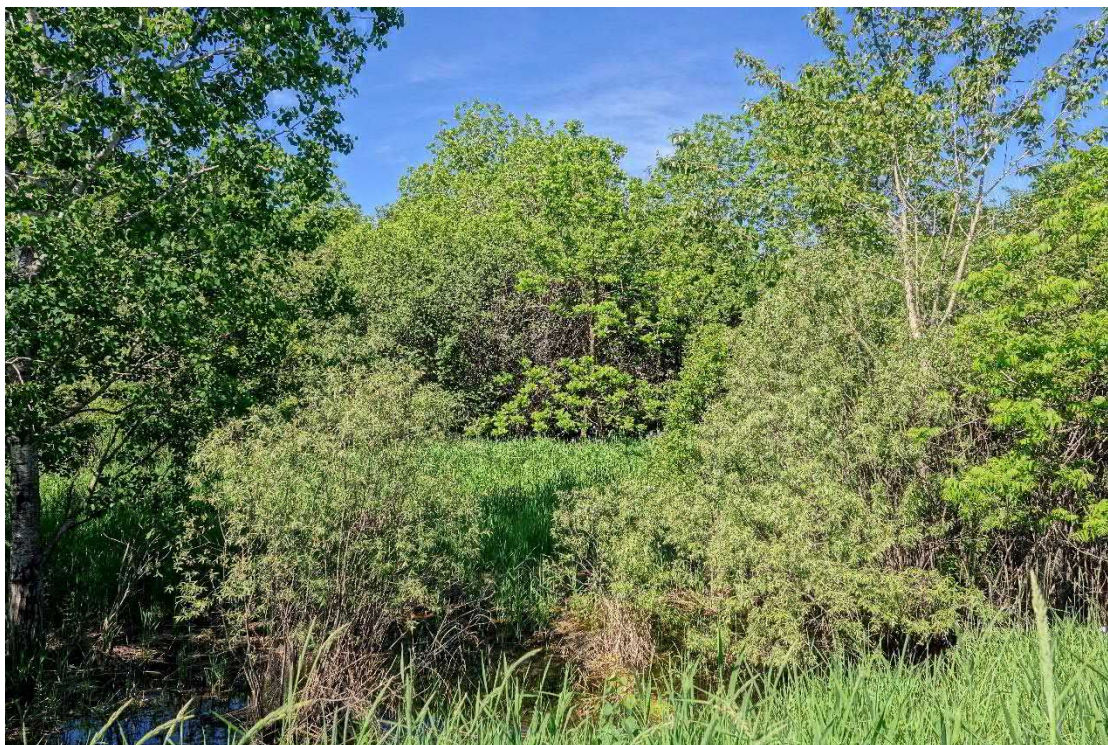

Photo 37: Fresh-Moist Poplar Deciduous Forest (FODM8-1) vegetation community adjacent to the southwest end of the study area. 17 June 2019.

APPENDIX B: CLEAN EQUIPMENT PROTOCOL FOR INDUSTRY

Clean Equipment Protocol for Industry

Inspecting and cleaning equipment for the purposes of invasive species prevention



Catalyst for research and response



Publication Information

Halloran, Joe, Anderson, Hayley and Tassie, Danielle. 2013. Clean Equipment Protocol for Industry. Peterborough Stewardship Council and Ontario Invasive Plant Council. Peterborough, ON.

Printed April 2013
Peterborough, Ontario

ISBN: (to be confirmed)

This document was prepared for the Canada-Ontario Invasive Species Centre and the Ontario Ministry of Natural Resources by the Peterborough Stewardship Council and the Ontario Invasive Plant Council.

Inquiries regarding this document can be directed to the Ontario Invasive Plant Council
PO Box 2800, 4601 Guthrie Drive
Peterborough, ON
K9J 8L5

Phone: (705) 748-6324
Email: info@ontarioinvasiveplants.ca

For more information on invasive plants in Ontario, visit www.ontario.ca/invasivespecies,
www.ontarioinvasiveplants.ca, www.invadingspecies.com or www.invasivespeciescentre.ca

Table Of Contents

Introduction	1
Why Cleaning Vehicles and Equipment is Important	3
Impacts of Invasive Species on Industry	4
Construction	4
Forestry/Agriculture	4
Land Management (Trail Use/Maintenance).....	4
Roadsides/Utilities	4
Steps to Prevent the Unintentional Introduction of Invasive Species from Equipment	5
When to Inspect	5
How to Inspect	5
When to Clean.....	6
Where to Clean	6
How to Clean Inside	6
How to Clean Outside	6
Final Inspection Checklist	7
Equipment Required	7
Inspection and Cleaning Diagrams and Checklists	8
2WD and 4WD Vehicles.....	8
Excavator	9
Backhoe.....	10
Bulldozer	11
Contacts and Resources	12
Appendix A: Identification of Invasive Plants found in Ontario	13

Introduction

Why Invasive Plants are a Problem

Invasive alien species are “a growing environmental and economic threat to Ontario. Alien species are plants, animals and microorganisms that have been accidentally or deliberately introduced into areas beyond their normal range. Invasive species are defined as harmful alien species whose introduction or spread threatens the environment, the economy, or society, including human health (Government of Canada 2004).” (Ontario Invasive Species Strategic Plan, 2012). The great majority of plant invasions occur in habitats that have been disturbed either naturally or by humans (Rejmanek 1989; Hobbs and Huenneke 1992; Hobbs 2000).

The ecological effects of invasive species are often irreversible and, once established, they are extremely difficult and costly to control or eradicate. According to Pimental et al. (1999), invasive species in the U.S. cause economic and environmental damages totalling over \$138 billion per year, with agricultural weed control and crop losses totalling approximately \$34 billion per year. Exact figures for the total economic and environmental damages are not available for Canada. In Ontario however, the costs of dealing with just one invasive species is astonishing; Zebra Mussels cost Ontario power producers who draw water from the lake \$6.4 million per year in increased control/operating costs and about \$1 million per year in research costs (Colautti et al. 2006).

Invasive species can spread to new areas when contaminated mud, gravel, water, soil and plant material are unknowingly moved by equipment used on different sites. This method of spread is called an unintentional introduction, and is one of the four major pathways for invasive species introduction into a new area of Ontario (Ontario Invasive Species Strategic Plan, 2012).



Buckthorn removal, Lynde Shores Conservation Area.
Photo by: Central Lake Ontario Conservation Authority

Invasive plant seed and propagules (plant material, i.e. rhizomes) have the ability to travel sight unseen in mud attached to or lodged in various parts and spaces between parts of vehicles, machinery and other mechanical equipment. A recent study at Montana State University found that most seeds (99% on paved roads and 96% on unpaved roads) stayed attached to the vehicle after traveling 160 miles (257 km) under dry conditions.

Invasive plant species are commonly transported on or in vehicles and construction equipment when they are moved to new locations. Those vehicles include four-wheel drives, excavators, tractors, loaders, water trucks and all-terrain vehicles. Failure to properly clean vehicles and machinery of soils, mud, and contaminated water that may contain invasive species seed and propagules can result in permanent, irreversible environmental impacts. These impacts can mean substantial cost to the landowner, land manager and/or the user. Businesses may also face liability issues for activities and operations that result in the introduction of invasive species.

Some of the invasive species in Ontario which have been known to spread through equipment transfer include:

- **Common Buckthorn** (*Rhamnus cathartica*)
- **Dog-strangling Vine** (*Cynanchum rossicum*)
- **Garlic Mustard** (*Alliaria petiolata*)
- **Giant Hogweed** (*Heracleum mantegazzianum*)
- **Glossy Buckthorn** (*Frangula alnus*)
- **Japanese Knotweed** (*Polygonum cuspidatum*)
- **Miscanthus or Chinese Silver Grass** (*Miscanthus sinensis*)
- **Phragmites or Common Reed** (*Phragmites australis* subsp. *australis*)
- **Reed Canary Grass** (*Phalaris arundinacea*)
- **Wild Parsnip** (*Pastinaca sativa*)
- **Wild Chervil** (*Anthriscus sylvestri*)



Dog-strangling vine
(*Cynanchum rossicum*)
Photo by: Hayley Anderson



Garlic Mustard
(*Alliaria petiolata*)
Photo by: Ken Towle



Phragmites
(*Phragmites australis* subsp. *Australis*)
Photo by: Michael Irvine

These plants impact biodiversity by out-competing native species for space, sunlight, and nutrients. They can also have impacts on road and driver safety by physically blocking intersection sightlines, and in the case of Phragmites and Miscanthus, may fuel intense grass fires if ignited, which can damage utility stations and hydro lines.

The harmful effects of invasive species include:

- Physical and structural damage to infrastructure
- Human health hazards (i.e. Giant Hogweed and Wild Parsnip exposure)
- Delays and increased cost in construction activities
- Environmental damage (i.e. erosion)
- Aesthetic degradation
- Loss of biodiversity
- Reduced property values
- Loss of productivity in woodlots and agriculture

Why Cleaning Vehicles and Equipment is Important

Passenger and recreational vehicles as well as heavy machinery are major vectors for spreading terrestrial invasive species into new areas.

It is much more costly to control invasive species after their establishment and spread than it is to prevent their spread. The spread of invasive species through unintentional introduction can be minimized significantly by the diligent cleaning of vehicles and equipment when leaving one site and moving to the next. In the case of large properties, cleaning before moving to a new site is recommended, even if it is within the same property.

This guide has been developed for the construction, agriculture, forestry and other land management industries, to provide equipment operators and practitioners with tools and techniques to identify and prevent the unintentional introduction of invasive species. It establishes a standard for cleaning vehicles and equipment and provides a guide where current codes of practice, industry standards or other environmental management plans are not already in place.

Passenger and recreational vehicles include:

- 2WD and 4WD cars
- 2WD and 4WD trucks
- All Terrain Vehicles (ATV's)
- Motorbikes
- Snowmobiles

Heavy machinery includes:

- Trucks
- Tractors
- Mowers
- Slashers
- Trailers
- Backhoes
- Graders
- Dozers
- Excavators
- Skidders
- Loaders
- Water Tankers and Trucks



Dog-strangling Vine plants attached to ATV.

Photo by: Francine Macdonald



Plant material attached to bobcat.

Photo by: TH9 Outdoor Services

Impacts of Invasive Species on Industry

Construction

In the UK, Japanese Knotweed (*Polygonum cuspidatum* or *Fallopia japonica*) is classified as a hazardous material. When construction occurs in established Japanese Knotweed stands workers sift the soil to remove root fragments and institute treatment plans to ensure that the Knotweed does not re-sprout, as it can damage housing foundations by growing through concrete and asphalt. The contractors must also thoroughly clean their equipment, and dispose of the contaminated soil at biohazard waste sites. While we do not have these requirements in Ontario, Japanese Knotweed is present here.

Invasive plant species can also increase site preparation and weed control costs, and reduce property values. For example, in Vermont the presence of the aquatic invasive plant Eurasian Watermilfoil (*Myriophyllum spicatum*) depressed shoreline residence property value by as much as 16.4% (Zhang and Boyle, 2010).

Forestry/Agriculture

Invasive plant species which become established in forests will out-compete native species and prevent forest re-generation after logging or natural disturbance. Dog-strangling Vine (*Cynanchum rossicum*) is of particular concern in conifer plantations. This species thrives in the filtered light and open soils of mature plantations, and suppresses seedling establishment of native hardwoods. If its invasion continues, very few juvenile trees will survive to fill the shrinking canopy of over-mature pines. Reforestation sites are also susceptible; the thick mats of vegetation and aggressive competition from Dog-strangling Vine decrease available planting space and increase costs as more mature vegetation needs to be planted in order to ensure the new vegetation can outcompete the invasive plant. As a result, expensive control programs are often required.

Land Management (Trail Use/Maintenance)

Recreational trail use and the maintenance of trails can facilitate the transport of invasive plant material and seeds, and create open and disturbed sites that are prime locations for the establishment of invasive species. Studies have proven that trails act as corridors which assist in the spread of invasive plant species. Humans, their pets, and vehicles such as ATV's can be vectors of invasion along trails because seeds and plant pieces can be carried on equipment and clothing. In addition, frequent trampling along trails alters soil properties, limits the growth of some native species, and creates conditions that may favour the growth of non-native species (Kuss et al. 1985; Marion et al. 1985; Yorks et al. 1997).

Roadsides/Utilities

Invasive species can increase the cost of roadside and utility maintenance by requiring additional maintenance and control efforts. The presence of invasive species can also provide a safety hazard. In the case of Phragmites and Miscanthus (invasive grass species), along with interrupting sight lines, the dead stalks which remain standing each autumn also provide combustible material. Fires in these stands burn intensely, and can damage utilities and hydro lines. Phragmites along roadsides is generally assumed to be spread through the transport and burial of rhizome fragments through ditching, ploughing, and other human activities that transport rhizomes on machinery. Studies have shown that vehicles and road-fill operations can transport invasive plant seeds into uninfested areas, and road construction and maintenance operations provide optimal disturbed sites for seed germination and seedling establishment (Schmidt 1989; Lonsdale & Lane 1994; Greenberg et al. 1997; Trombulak & Frissell 2000).

Steps to Prevent the Unintentional Introduction of Invasive Species from Equipment

Inspection and cleaning of all machinery and equipment should be performed in accordance with the procedures, checklists and diagrams provided in this protocol.

When visiting more than one site, always schedule work in the sites that are the least disturbed and free of known invasive species first, and visit sites with known invasive species infestations last. This will greatly reduce the risk of transferring plants to new locations.

When to Inspect

Inspection should be done before:

- Moving vehicles out of a local area of operation
- Moving machinery between properties or sites within the same property where invasive species may be present in one area, and not in another
- Using machinery along roadsides, in ditches, and along watercourses
- Vehicles using unformed dirt roads, trails or off road conditions
- Using machinery to transport soil and quarry materials
- Visiting remote areas where access by vehicles is limited

Inspection should be done after:

- Operating in areas known to have terrestrial invasive plants or are in high risk areas (i.e. recently disturbed areas near known invaded areas)
- Transporting material (i.e. soil) that is known to contain, or has the potential to contain, invasive species
- Operating in an area or transporting material that you are uncertain contain invasive species
- In the event of rain. If mud contains seeds, they can travel indefinitely until it rains or the road surface is wet, allowing for long distance transport. This may result in transporting seeds to areas where those species did not previously exist

How to Inspect

- Inspect the vehicle thoroughly inside and out for where dirt, plant material and seeds may be lodged or adhering to interior and exterior surfaces.
- Remove any guards, covers or plates that are easy to remove.
- Attention should be paid to the underside of the vehicle, radiators, spare tires, foot wells and bumper bars.

If clods of dirt, seed or other plant material are found, removal should take place immediately, using the techniques outlined below.

When to Clean

Vehicles and heavy equipment that stay on formed and sealed roads have a low risk of spreading invasive species. Cleaning is only required when inspection identifies visible dirt clods and plant material or when moving from one area to another.

Depending on the invasive species present, vehicles may need to be cleaned even when deep snow is present. Phragmites, for example, can still be spread, even in packed snow because the seed heads are usually above the surface of the snow. Other plants, such as Dog-strangling vine, will be contained beneath deep snow.

**Regular inspection of vehicles and machinery will identify if any soil or plant material has been collected on or in vehicles and machinery.*

Where to Clean

Clean the vehicle/equipment in an area where contamination and seed spread is not possible (or limited). The site should be:

- Ideally, mud free, gravel covered or a hard surface. If this option is not available, choose a well maintained (i.e. regularly mowed) grassy area.
- Gently sloping to assist in draining water and material away from the vehicle or equipment. Care should be taken to ensure that localized erosion will not be created, and that water runs back into the area where contamination occurred.
- At least 30m away from any watercourse, water body and natural vegetation.
- Large enough to allow for adequate movement of larger vehicles and equipment.

**Safely locate the vehicle and equipment away from any hazards. If mechanized, ensure engine is off and the vehicle or equipment is immobilized.*

How to Clean Inside

Clean the interior of the vehicle by sweeping, vacuuming or using a compressed air device. Particular attention should be paid to the floor, foot wells, pedals, seats and under the seats.

How to Clean Outside

Knock off all large clods of dirt. Use a pry bar or other device if necessary.

Identify areas that may require cleaning with compressed air rather than water such as radiators and grills. Clean these areas first prior to using water.

Clean the vehicle with a high pressure hose in combination with a stiff brush and/or pry bar to further assist the removal of dirt clods.

Start cleaning from the top of the vehicle and work down to the bottom.

Emphasis should be placed on the undersides, wheels, wheel arches, guards, chassis, engine bays, radiator, grills and other attachments.

When the cleaning is finished avoid driving through the waste water when removing the vehicle or equipment from the cleaning site.

For equipment such as water trucks that may be exposed to aquatic invasive species, trucks should be disinfected with bleach solution before conducting work in a new area. For further information please refer to the Invading Species Awareness Program's Technical Guidelines listed under Contacts and Resources.



Hosing down a vehicle in Queensland Australia

Photo by: TH9 Outdoor Services

Final Inspection Checklist

Conduct a final inspection to ensure the following general clean standard has been achieved:

- No clods of dirt should be visible after wash down.
- Radiators, grills and the interiors of vehicles should be free of accumulations of seed, soil, mud and plant material parts including seeds, roots, flowers, fruit and or stems.

Diagrams have been provided to assist in quickly identifying key areas to inspect and clean on a variety of vehicles associated with the targeted industries. These can be used in combination with vehicle checklists to ensure all areas of the vehicles have been inspected and cleaned.

Equipment Required

- A pump and high pressure hose OR High pressure water unit
- Minimum water pressure for vehicle cleaning should be at least 90 pounds per square inch. Water can be supplied as high volume/low pressure or low volume/high pressure (NOAA Fisheries Service).
- Air compressor and blower OR Vacuum
- Shovel
- Pry bar
- Stiff brush or broom



Cleaning station at construction site.

Photo by: Mark Heaton, OMNR

Inspection and Cleaning Diagrams and Checklists

2WD and 4WD Vehicles

4WD VEHICLE WITH KEY SPOTS TO CHECK AND CLEAN

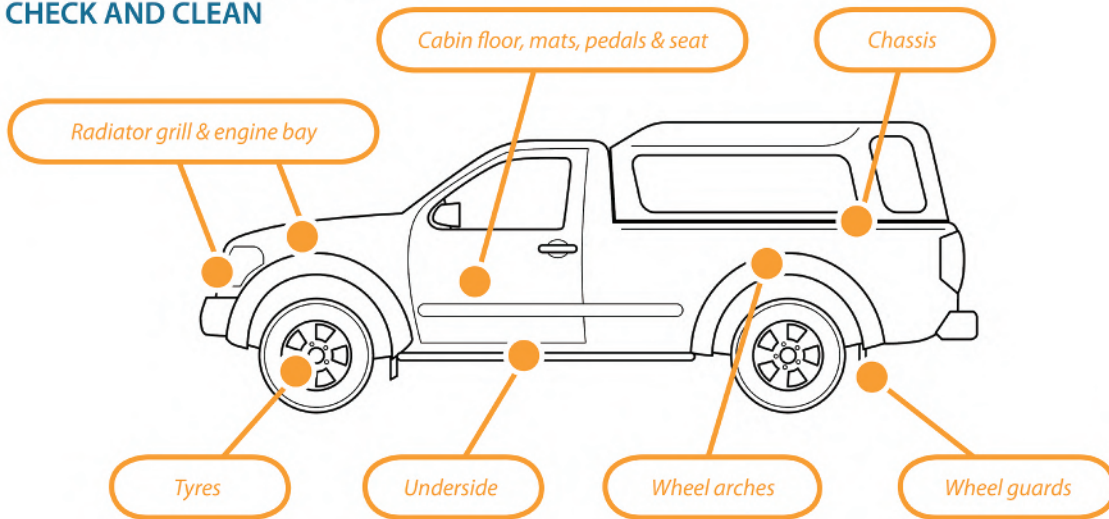

		✓
Cabin	Floor, mats, pedals, seats	
Engine	Radiators, engine bay, grill	
Body	Underside, chassis, crevices, ledges, bumper bars	
Wheels	All wheels (including spare), wheel arches, guards	
Tray	Floor, canopy (if included)	

Excavator

EXCAVATOR WITH KEY SPOTS TO CHECK AND CLEAN

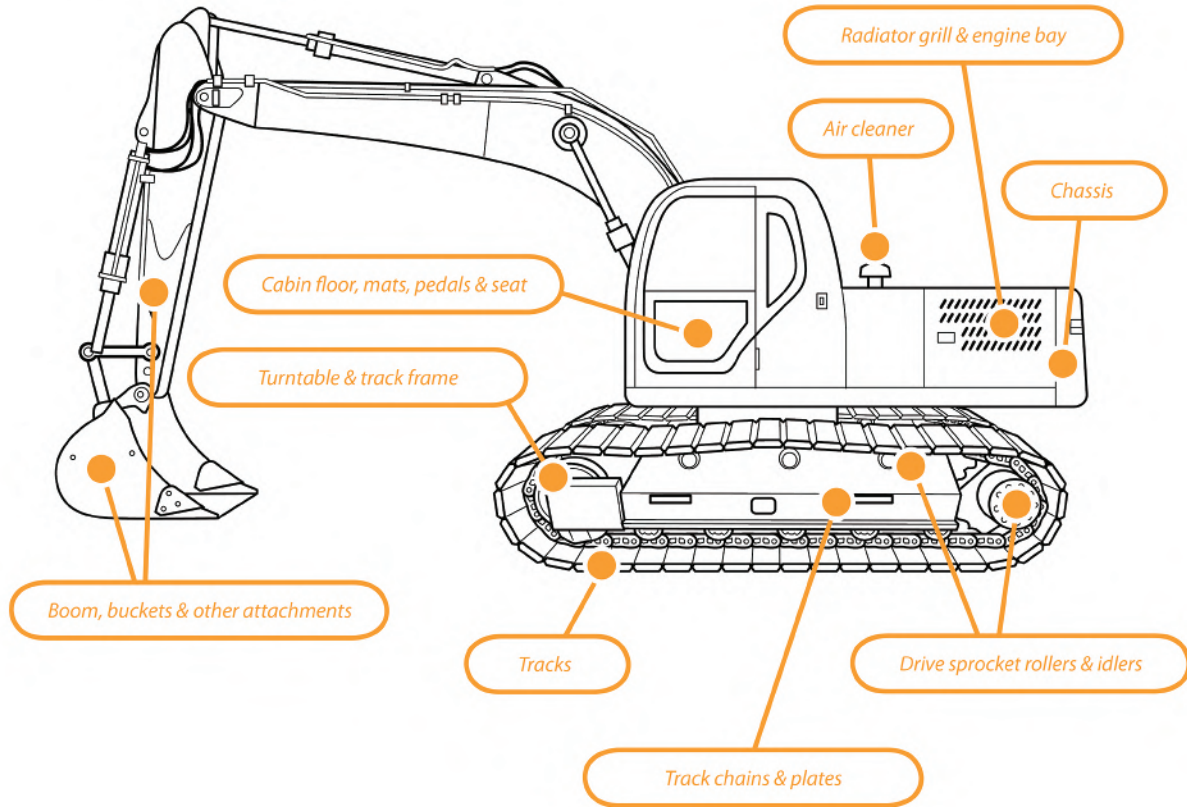

		✓
Cabin	Floor, mats, pedals, seats	
Engine	Radiators, engine bay, grill, air cleaner	
Tracks	Tracks, track frame, drive sprocket rollers, idlers	
Body Plates	Plates of cabin	
Body	Ledges, channels	
Bucket		
Booms		
Turret Pivot		

Backhoe

BACKHOE WITH KEY SPOTS TO CHECK AND CLEAN

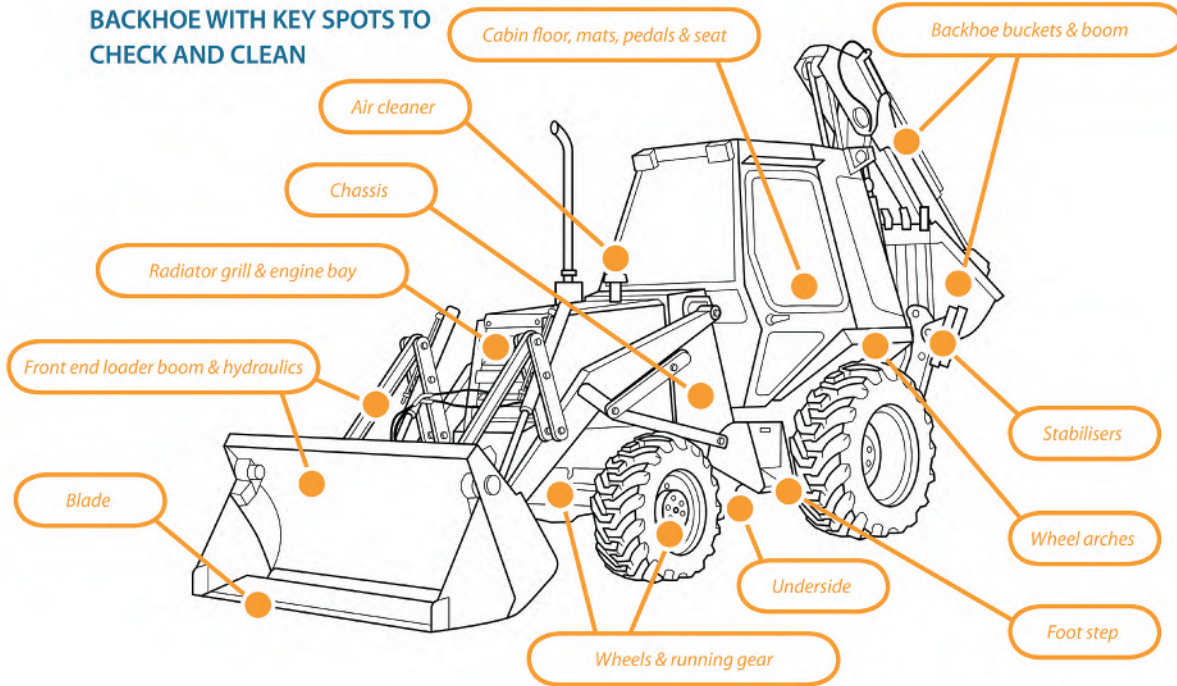

		✓
Cabin	Floor, mats, pedals, seats, foot step	
Engine	Radiators, engine bay, grill, air cleaner	
Wheels	All wheels (including spare), wheel arches, guards	
Front end loader	Blade, hydraulics, booms	
Backhoe	Buckets, boom, hydraulics, stabilizers	

Bulldozer

BULLDOZER WITH KEY SPOTS TO CHECK AND CLEAN

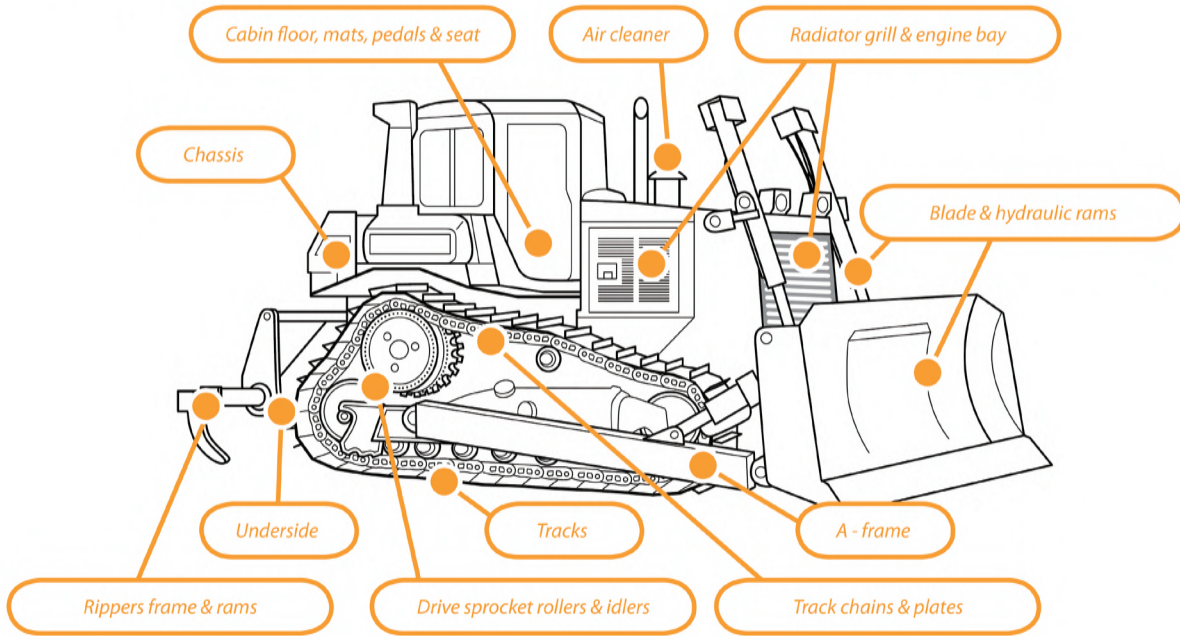

		✓
Cabin	Floor, mats, pedals, seats	
Engine	Radiators, engine bay, grill, air cleaner	
Tracks	Tracks, track frame, drive sprocket rollers, idlers	
Body Plates	Belly plates and rear plates	
Body	Ledges, channels	
Blade	Pivot points, hydraulic rams, a-frame	
Ripper	Ripper frame, ripper points	

Contacts and Resources

Ontario Invasive Species Strategic Plan 2012. Government of Ontario. Online, accessed May 8, 2012.

http://www.mnr.gov.on.ca/stdprodconsume/groups/lr/@mnr/@biodiversity/documents/document/stdprod_097634.pdf

Invasive Species Management for Infrastructure Managers and the Construction Industry 2008. Wade, M. Booy, O. and White, V. Online, accessed April 27, 2012

http://www.ciria.org/service/Web_Site/AM/ContentManagerNet/ContentDisplay.aspx?Section=Web_Site&ContentID=9001

T.I.P.S (Targeted Invasive Plant Solutions) Highway Operations. British Columbia Invasive Species Council. Online, accessed May 8, 2012

http://www.bcinvvasiveplants.com/iscbc/publications/TIPS/Highways_Operations_TIPS.pdf

Invading Species Awareness Program Workshop Manual: Aquatic Invasive Species: An Introduction to Identification, Collection and Reporting of Aquatic Invasive Species in Ontario Waters (includes information on decontaminating equipment).

<http://www.invadingspecies.com/download/publications/manuals/WorkshopManual.pdf>

Reporting Invasive Species

To report invasive species, or view maps of existing records, visit the Invading Species Awareness Program website www.invadingspecies.com/report/ or www.eddmaps.org/Ontario.

Or call the OFAH/MNR Invading Species Awareness Program Hotline at **1-800-563-7711**

Acknowledgements

We gratefully acknowledge NRM South (Tasmania, Australia) for allowing the use of their artwork and text from their “Keeping it Clean – A Tasmanian Field Hygiene Manual to Prevent the Spread of Freshwater Pests and Pathogens”.

We also sincerely thank the Clean Equipment Protocol Working Group and the Ontario Invasive Plant Council Committees and Board of Directors for their ongoing support and valuable input into this document, and the Canada-Ontario Invasive Species Centre and Ontario Ministry of Natural Resources for the support in creating this protocol.

Clean Equipment Protocol Working Group:

Diana Shermet, Central Lake Ontario Conservation Authority; Paula Berketo, Ontario Ministry of Transportation; Travis Cameron, Ontario Ministry of Natural Resources; Jennifer Hoare, Ontario Parks; Michael Irvine, Ontario Ministry of Natural Resources; Alison Kirkpatrick, OFAH/MNR Invading Species Awareness Program; Erika Weisz, Ontario Ministry of Natural Resources; Amanda Chad, Ontario Power Generation; Nancy Vidler, Lambton Shores Phragmites Community Group; Nigel Buffone, Du Pont Canada Company; Ewa Bednarczuk, Lower Trent Conservation Authority

We also gratefully acknowledge the input and direction from Francine MacDonald, James Rockwood, Anne-Marie Roussy, Stephen Smith, Caroline Mach, Patricia Lowe, John Bowen, Karen Hartley, and the Southern Ontario Community Forest Managers group.

More Information:

Ontario Invasive Plant Council: www.ontarioinvasiveplants.ca

Appendix A: Identification of Invasive Plants found in Ontario

- **Common Buckthorn** (*Rhamnus cathartica*) and **Glossy Buckthorn** (*Frangula alnus*)
- **Dog-strangling Vine** (*Cynanchum rossicum*)
- **Garlic Mustard** (*Alliaria petiolata*)
- **Japanese Knotweed** (*Polygonum cuspidatum*)
- **Phragmites or Common Reed** (*Phragmites australis subsp. australis*)
- **Giant Hogweed** (*Heracleum mantegazzianum*)

common & glossy buckthorn

(*Rhamnus cathartica* & *R. frangula*)



Plant type: Shrub/small tree

Arrangement: Common buckthorn are sub-opposite (almost opposite). Glossy buckthorn are alternate.

Leaf: The common buckthorn leaf is egg shaped, edge of the leaf is “pebbled” (small rounded teeth). Veins converging toward leaf top. The glossy buckthorn leaf is more slender (tear drop shaped) and smooth margined.

Bark: Smooth, young bark with prominent raised patches or lenticels; rough texture and peeling bark when mature.

Seed/Flowers: Flowers are green-yellowish, small and inconspicuous. Green berries becoming purplish/black in late summer, berry > 1 cm in diameter.

Buds/Twigs: Common buckthorn has thorn-like tip on many twigs. Glossy buckthorn buds have no bud scales and lack thorny tips to twigs.

Habitat: Various - forest, thickets, meadows, dry to moist soils.

Similar native species: Native dogwoods, which lack the thorny “tip”. Native dogwoods are truly opposite in arrangement of twigs; only alternate leaved (pagoda) dogwood has alternate branching.

dog-strangling vine

(*Cynanchum rossicum* & *C. nigrum*)



Plant type: Herb, twining vine

Arrangement: Opposite

Leaf: Lance shaped, smooth margin (edge)

Bark: n/a

Seed/Flowers: Bean shaped seed pod with seeds attached to downy 'umbrellas'. Flowers - pink (*C. rossicum*) or purple (*C. nigrum*) with five petals.

Buds/Twigs: n/a

Habitat: Dry to moist soils; more dominant in meadows and woodland edges.

Similar native species: Swamp milkweed (*Asclepias incarnata* spp.), is an upright plant, typically found in wetland habitats.

garlic mustard

(*Alliaria petiolata*)



Plant type: Herb

Arrangement: Alternate

Leaf: Saw tooth like edge, elongated heart shape. Garlic/onion smell when crushed. Leaves are kidney shaped with prominent veins.

Bark: n/a

Seed/Flowers: Cluster of small white flowers with four petals. Small black < 1 mm rounded seed found in elongated 'tube-like' seed pods (similar to a bean pod).

Buds/Twigs: n/a

Habitat: Various – dry to moist soils, in all habitat types, less often in meadows.

Similar native species: n/a

japanese knotweed

(*Polygonum cuspidatum*)



Plant type: Herb, 2 - 4 m in height.

Arrangement: Alternate

Leaf: Tear drop shaped, sharp pointed, dark green, flattened at base.

Bark: n/a

Seed/Flowers: Flowering stalk of many small greenish-white flowers.

Buds/Twigs: Large plant with a 'bamboo-like' stem. Stem light green maturing to tan colour.

Habitat: Moist to wet soils found in wetlands, water-courses and roadside ditches.

Similar native species: None.

common reed

(*Phragmites australis*)



Plant type: Grass

Arrangement: Alternate

Leaf: Broad leaf > 1 cm wide.

Bark: n/a

Seed/Flowers: Dense cascading 'broom-like' flower head. 'Cottony' in appearance when mature.

Buds/Twigs: Stems rough and ridged, ligule a densely hairy band. Mature plants > 3 m tall.

Habitat: Moist to wet soils. Found in wetlands, water-courses and road side ditches.

Similar native species: Species of mannagrass (*Glyceria* sp) including tall northern, eastern and rattlesnake grass. A native common reed exists but has a smooth stem and the ligule is not hairy. It is also quite rare.

giant hogweed

(*Heracleum mantegazzianum*)



Plant type: Herb. Mature plants can be over 3m tall.

Arrangement: Alternate

Leaf: Lobed leaf 1-2 m wide, lobes sharp-pointed.

Bark: n/a

Seed/Flowers: Small, white flowers in a large umbrella-shaped cluster, .75 m wide.

Buds/Twigs: Hairy stem with purple spots.

Habitat: Fresh to wet soils in forests, swamps, meadows, marshes.

Similar native species: Cow parsnip (*Heracleum maximum*) – has smaller flowers, no purple spots on stems. Angelica (*Angelica atropurpurea*) has a rounded-topped flower cluster and leaves divided into many leaflets.

Do not touch this plant because it is poisonous. If you do, wash your skin immediately in cool soapy water and do not expose the area to sunlight.

Seek professional advice before removing.

Identification of Invasive Plants found in Ontario Photos by:

Credit Valley Conservation, Greg Bales, Ken Towle, Patrick Hodge,
Ontario Federation of Anglers and Hunters, Francine Macdonald, Matt Smith

APPENDIX C: BUTTERNUT HEALTH ASSESSMENT REPORT

Enclosures:

1. Information from the Ministry of Natural Resources and Forestry about Butternut and the *Endangered Species Act, 2007*
2. Butternut Health Assessor's Report
3. Original data forms
4. Electronic and printed copies of the Excel data spreadsheet (BHA Tree Analysis)

Butternut Trees on Your Property

INTRODUCTION

The Ministry of Natural Resources is streamlining and automating its approvals processes for natural resource-related activities – with the goal of providing individuals and businesses with faster and more efficient service delivery.

This fact sheet provides information about regulatory provisions under the Endangered Species Act (ESA) for activities that may impact butternut trees.

The ESA provides protection for endangered or threatened species in Ontario. Some activities that would otherwise contravene the ESA may be eligible to proceed without a permit from the Ministry of Natural Resources provided that regulatory conditions for the ongoing protection of species at risk and their habitats are met.

ACTIVITIES THAT MAY AFFECT BUTTERNUT

Anyone intending to cut down or harm butternut trees may be able to follow the rules set out in the regulation, depending on the health of the trees as determined by a qualified butternut health assessor and the number of trees impacted. In some cases, this will include a requirement for the person to register with the Ministry of

Natural Resources. A permit under the ESA is not required if the rules in regulation are followed for all eligible activities.

What is a “qualified butternut health assessor?”

A butternut health assessor is a person designated by the Ministry of Natural Resources for the purpose of assessing whether, and the extent to which, butternut trees are affected by a disease called butternut canker.

What are the categories for butternut trees?

A qualified butternut health assessor must inspect and report on the tree, and then assign it to one of three categories, based on the tree's condition or value as a genetic resource. The categories are:

- Category 1: the tree is in an advanced state of disease from butternut canker and is considered “non-retainable.”
- Category 2: the tree does not have butternut canker, or the disease is not as advanced and the tree is considered “retainable.”
- Category 3: the tree may be useful in determining sources of resistance to butternut canker and is considered “archivable.” This regulation does not apply to Category 3 trees.

2 Butternut Trees on Your Property

What activities are eligible?

This section may apply to anyone who is proposing an activity that may have an impact on a butternut tree. The butternut must be assessed by a qualified butternut health assessor, and the regulation may apply depending on the number of trees proposed to be affected, and the category of the tree.

A person may be eligible if the activity affects Category 1 trees or 10 or fewer Category 2 trees.

A person is not eligible for the regulation and must obtain an ESA authorization if the activity affects a Category 3 tree, or more than 10 Category 2 trees.

What activities are not eligible?

- A person cannot affect more than 10 Category 2 trees identified in the butternut health assessors report.
- The regulation does not apply if a person has been previously exempted to remove 10 butternut trees, identified by a butternut health assessor as Category 2 trees and the location of the trees are in the same area or close proximity, the person is proposing to have an impact on additional butternut trees for the same or similar reasons.

What are the rules in regulation?

At least 30 days before any butternut is killed, harmed or taken:

- A designated butternut health assessor must;
- complete an assessment for each butternut tree in accordance with the "Butternut Assessment

Guidelines: Assessment of Butternut Tree Health for the Purposes of the Endangered Species Act, 2007" published by the Ministry of Natural Resources and designate it as Category 1, 2, or 3;

- provide a written report of the assessment in accordance with those guidelines.
- The person proposing to carry out the activity must send the report of the butternut health assessor to the appropriate MNR District Manager and allow MNR staff to access the site during that time, if requested.

After the 30 day period has passed, the person may carry out activities on any Category 1 trees identified in the report.

If 10 or fewer Category 2 trees are affected (and the activity is not otherwise ineligible), the person carrying out the activity must:

- Register using the Notice of Butternut Impact form on the Registry.
- Follow the rules in regulation including:
 - Plant replacement trees to benefit butternut using best management practices outlined in the regulation.
 - Conduct monitoring and tending of the seedlings that are planted.
 - Keep required records.

Please refer to **Legal/Technical Background** below for a summary of these conditions.

3 Butternut Trees on Your Property

LEGAL/TECHNICAL BACKGROUND

The following is a summary of the conditions in the regulation that must be fulfilled to allow eligible activities, and is for information purposes only. Please refer to O.Reg. 242/08 section 23.7 at e-laws.gov.on.ca for the full legal text.

Summary of Conditions

Actions to Benefit Butternut:

The person must provide a benefit for butternut by carrying out these activities:

- follow planting ratios as described in the regulation for replacing the trees, based on the size of the tree(s) and whether the tree is being killed and taken or harmed;
- follow the rules in regulation regarding seed origin, timing of planting, soil characteristics, companion trees plantings and spacing requirements; and,
- replace planted butternut that die within two years of planting the seedling.

Monitoring and Tending:

The person must monitor and tend the planted butternut trees by following requirements described in the regulation:

- monitor planted trees once annually for two years between May 15 and September 20 to assess the health of each tree;
- tend each butternut tree planted once a week during the first growing season (May 15 – September 20) which includes maintenance of tree guards, vegetation control and watering; and,

- tend each butternut tree planted in the second growing season as required by completing vegetation control and watering.

Records:

The person must maintain a record of planting, monitoring and tending activities for every planted butternut tree and provide this record to MNR should it be requested. This record must include planting dates, dates and description of monitoring and tending activities and the health status of each tree, including any signs of butternut canker.

IMPORTANT LINKS

For more information about Ontario's species at risk, visit ontario.ca/speciesatrisk.

FOR MORE INFORMATION

1-855-613-4256

Email: mnr.rasc@ontario.ca

Ministry of Natural
Resources and Forestry

Species At Risk
P.O. Box 7000, 300 Water Street
Peterborough ON K9J 8M5

Ministère des Richesses
naturelles et des Forêts

Espèces en péril
C.P. 7000, 300, rue Water
Peterborough ON K9J 8M5

The enclosed Butternut Health Assessor's Report documents the results of the Butternut health assessment that was conducted by the designated Butternut Health Assessor (BHA) identified in the top section of the report. If there are other Butternut trees (of any size or age) at the site that may be affected by the activity and they are not identified in the enclosed BHA Report, they too must be assessed by a designated BHA.

Butternut is listed as an endangered species on the Species at Risk in Ontario List, and as such, it is protected under the *Endangered Species Act, 2007* (ESA) from being killed, harmed, or removed. If you are planning to undertake an activity that may affect Butternut, you may be eligible to follow the requirements set out in section 23.7 of Ontario Regulation 242/08 under the ESA, or you may need to seek an authorization under the ESA (e.g., a permit).

Please visit e-laws at the link provided below for the legal requirements of eligible activities under section 23.7 of Ontario Regulation 242/08 and conditions that must be fulfilled. Information about Butternut is also available at: <http://www.ontario.ca/environment-and-energy/butternut-trees-your-property>.

If you are eligible to kill, harm or take Butternut under section 23.7 of the regulation, your first step is to submit the BHA Report and the original data forms enclosed in this package to the local Ministry of Natural Resources and Forestry (MNRF) District Manager. Note that MNRF cannot accept photocopies or scanned electronic copies of the data forms.

Note regarding changes:

If the enclosed BHA Report does not identify which Butternut tree(s) are proposed to be killed, harmed, or taken in Table 1 (i.e., if "unknown" is indicated in the second last column of Table 1), or, if the information in the last two columns of Table 1 has changed since the date this BHA Report was produced, **do not make any edits to the BHA Report**. Instead, please attach a cover letter that identifies which Butternut tree(s) are proposed to be killed, harmed, or taken (by referencing the tree identification numbers) when you submit the enclosed BHA Report to the local MNRF District Manager.

The BHA Report must be submitted at least 30 days prior to registering an eligible activity to kill, harm, or remove a Butternut tree. During this 30 day period, no Butternut trees (of any category) may be killed, harmed, or removed, and MNRF may contact you for an opportunity to examine the trees. If MNRF chooses to examine the trees, a representative of MNRF will contact you using the information you supplied when you submitted the BHA Report.

If you are eligible to follow the rules in regulation under section 23.7, you may register your activity using the "Notice of Butternut Impact" form on the [MNRF Registry](#) **after the 30 day period has elapsed**.

If you are **not** eligible to follow the rules in regulation under section 23.7, please contact the local MNRF district office to determine whether you will need to seek an authorization (e.g., a permit). A link to the directory of MNRF offices is provided below.

Note that municipal by-laws and legislation other than the ESA may also be applicable to the removal or harming of trees.

Please retain this information and a copy of the BHA Report (including copies of all data forms) for your records, along with any other documentation you may receive from MNRF should an examination of the trees occur. If you have any questions, please contact your local MNRF district office.

Links:

Endangered Species Act, 2007:

http://www.e-laws.gov.on.ca/html/statutes/english/elaws_statutes_07e06_e.htm

Ontario Regulation 242/08 (refer to section 23.7):

http://www.e-laws.gov.on.ca/html/regs/english/elaws_regs_080242_e.htm

MNRF Office Locations:

<https://www.ontario.ca/government/ministry-natural-resources-and-forestry-regional-and-district-offices>

Butternut Health Assessor's Report Number: 289-006

Heather Lunn BHA #289
1909 Sixth Line Road
Dunrobin, Ontario
K0A 1T0
343-262-4769
heather.lunn@gmail.com

Maurice DeCaria
Perthmore Development Co. Ltd.
80 Dufferin St.
P.O. Box 20054
Perth, ON
K7H 3M6
(416) 697-3804
Maurice@perthmore.com

Site location: Lot 03 Concession 02 Geographic Township of Drummond, Town of Perth

Date(s) of Butternut health assessment: June 22, 2019
Date BHA Report prepared: August 30, 2019

Map datum used: NAD83 WGS84

Total number of trees assessed in this BHA Report: 1

The assessed trees were numbered on site using white flagging tape and numbered on the flagging tape with a black marker. The numbers at the site correspond to the tree numbers referenced in this report.

This BHA Report includes the following tables:

- Table 1: Butternut Trees Assessed
- Table 2: Trees Determined by BHA to be Butternut Hybrids
- Table 3: Summary of Assessment Results

Table 1: Butternut Trees Assessed

Tree #	UTM coordinates	Category (1, 2, or 3)	dbh (cm)	Cultivated? (Y/N)	Proposed to be: (enter one: unknown, killed, harmed or taken)	If tree is proposed to be killed, harmed, or taken, indicate reason tree is proposed to be killed, harmed or taken:
1	18T 401236 4974211	2	62	N	Unknown	N/A

Table 2: Trees Determined by BHA to be Butternut Hybrids

Tree #	UTM coordinates	Method used (genetic testing or field identification):

Table 3: Summary of Assessment Results

Result:	Total #:	Important information for persons planning activities that may affect Butternut:
Category 1	0	<ul style="list-style-type: none"> A Category 1 tree is one that is affected by butternut canker to such an advanced degree that retaining the tree would not support the protection or recovery of butternut in the area in which the tree is located; and is considered "non-retainable". During the 30 day period that follows your submission of this BHA Report to the MNRF District Manager, no Butternut trees (of Category 1, 2, or 3) may be killed, harmed, or taken, and MNRF may contact you for an opportunity to examine the trees. Category 1 trees may be killed, harmed or taken after the 30 day period that follows submission of this BHA Report to the MNRF District Manager, unless the results of an MNRF examination indicate that the assessment has not been conducted in accordance with the document entitled "Butternut Assessment Guidelines: Assessment of Butternut Tree Health for the Purposes of the <i>Endangered Species Act, 2007</i>".
Category 2	1	<ul style="list-style-type: none"> A Category 2 tree is one that is not affected by Butternut Canker, or is affected by Butternut Canker but the degree to which it is affected is not too advanced and retaining the tree could support the protection or recovery of butternut in the area in which the tree is located, and is considered "retainable". During the 30 day period that follows your submission of this BHA Report to the MNRF District Manager, no Butternut trees (of Category 1, 2, or 3) may be killed, harmed, or taken, and MNRF may contact you for an opportunity to examine the trees. Activities that may kill, harm or take up to a maximum of ten (10) Category 2 trees may be eligible to follow the rules in section 23.7 of Ontario Regulation 242/08, in accordance with the conditions and requirements set out in the regulation. Refer to e-Laws for the legal requirements of eligible activities under section 23.7 of Ontario Regulation 242/08 and conditions that must be fulfilled: http://www.e-laws.gov.on.ca/html/regs/english/elaws_regs_080242_e.htm Activities that may kill, harm or take more than ten (10) Category 2 trees are not eligible to follow the rules in section 23.7 of Ontario Regulation 242/08. Contact the local MNRF district office for information on how to seek an ESA authorization (e.g., a permit) or consider an alternative that would be eligible for the regulation.
Category 3	0	<ul style="list-style-type: none"> A Category 3 tree is one that may be useful in determining sources of resistance to Butternut Canker, and is considered "archivable". Category 3 trees are not eligible to be killed, harmed or taken under section 23.7 of Ontario Regulation 242/08. Contact the local MNRF district office for information on how to seek an ESA authorization, or consider an alternative that will avoid killing, harming or taking any Category 3 trees.
Cultivated	0	<ul style="list-style-type: none"> An activity that involves killing, harming, or taking a cultivated Butternut tree that was not required to be planted to fulfill a condition of an ESA permit or a condition of a regulation, may be eligible for the exemption provided by subsection 23.7 (11) of O. Reg. 242/08. Prior to undertaking the activity, the owner or occupier of the land on which the Butternut is located (or person acting on their behalf) will need to determine whether the exemption for cultivated trees is applicable by determining whether or not the tree was cultivated as a result of the requirements for an exemption under O. Reg. 242/08 or a condition of a permit issued under the ESA. This information can be accessed by contacting the local MNRF district office. The owner or occupier of the land on which the Butternut is located (or person acting on their behalf) is encouraged to append the details regarding whether the tree was planted to satisfy a requirement (e.g., the permit number or registration number) to this BHA Report for their records.
Hybrid	0	<ul style="list-style-type: none"> Hybrid Butternut trees are not protected under the ESA, but their removal may be subject to municipal by-laws and other legislation.

Butternut Health Assessor's Comments:

This concludes the summary of the BHA Report. A complete BHA Report must also include:

1. All original (hard copy) data forms (i.e., all completed sets of Form 1 and Form 2), and
2. Electronic and printed copies of the Excel data analysis spreadsheet.

Butternut Data Collection Form 1 - 2010 Edition

Surveyor ID or BHA #

(PLEASE USE BLOCK LETTERS)

Date (dd/mm/yyyy)

- -

Shaded fields are mandatory for Butternut Health Assessments

Surveyor Contact
 First Last
 Email
 Telephone (Telephone Other () X

Property Owner
 (check if same as surveyor)
 First Last
 or Company
 Email
 Telephone (Telephone Other () X

Property Owner's Mailing address
 Address Postal Code Prov.
 City

Tree Location (if different from mailing address)
 Address/(911#)
 Township Lot Con
 City

Directions

Yes No Can Share Location Information with other Butternut Recovery Organizations?
 Yes No Site visits OK? (prior arrangements will always be made for a site visit)

Butternut Trees Tally by Diameter Class

(Do a dot tally in blank space; write total# in box for each)

Tree Condition	< 3 cm	3-15 cm	16-30cm	>30 cm
Vigorous: > 50% Live Crown Minor or no cankers	<input type="text"/>	<input type="text"/>	<input type="text"/>	<input type="text" value="01"/>
Poor Vigor: <50% Live Crown or >50% Live Crown + heavily cankered stem	<input type="text"/>	<input type="text"/>	<input type="text"/>	<input type="text"/>
Dead	<input type="text"/>	<input type="text"/>	<input type="text"/>	<input type="text"/>

Historically, do some trees produce seeds? Y N Unknown

Estimated area containing butternut for properties > 1 acre (0.4 hectares): Acres Hectares

Overall Property Description (area(s) containing Butternut)

- Rolling Upland Bottomland
- Valley Slope Variable
- Tableland Unknown

Vegetation Community/ies

- Open Fencerow
- Shrubland Roadside
- DeciduousForest Quarry
- ConiferForest UrbanYard
- MixedForest UrbanPark

Other

Soil Drainage

- Well Drained
- Moderately Drained
- Poorly Drained
- Unknown

Soil Depth

- > 1metre
- 30 - 99cm
- < 30cm
- Variable

Soil Texture

- Clay Sand
- Clay Loam Variable
- Loam Unknown
- Loamy Sand

Unknown

Please enter matching numerical page link code on forms 1 and 2

Page Link

(Contact Information follows all applicable privacy policies and guidelines)

Please return forms to:
 Forest Gene Conservation Association
 Suite 233, 266 Charlotte St.
 Peterborough, ON, K9J 2V4
 www.fgca.net

49731

Butternut Data Collection FORM 2 (2010 Edition)

(PLEASE USE BLOCK LETTERS)

Fill when Form 1 indicates canker is well established. The information on Form 2 must be filled out for all trees when doing a Butternut Health Assessment.

Shaded fields are mandatory for Butternut Health Assessments

001 Site Code(A,B,...Z, AA...)

Surveyor ID or BHA # 289

Date (dd/mm/yyyy) 22-06-2019

Surveyor Last Name LUNN

Tree ID Numbering: 1,2,3,...Starting from 1 for each site

Tree # Zone Easting Northing
001 1 840 1236 4974 211

Crown Class 75 Live Crown % 04 Main Stem Length(m) Below crown Seed Signs
 Twig Dieback 1 #Stems Butternut Origin Male Flowers
 Branch Dieback Natural Female Flowers
 Defoliation Planted Seed Set
 Discolouration 62 DBH(cm) Unknown None

Assess below live crown
 #Epic-Live 00 #Open #Sooty
 #Epic-Dead 00 Root 02 00
 Bark Type =<2m 00 00
 # Callused Wounds >2m 01 00

Metres from badly cankered tree
 < 40 > 40 None Found

Competing Species
 FRAXAME
 QUERMAC
 TILIAME

Tree # Zone Easting Northing
 1

Crown Class Live Crown % Main Stem Length(m) Below crown Seed Signs
 Twig Dieback #Stems Butternut Origin Male Flowers
 Branch Dieback Natural Female Flowers
 Defoliation DBH(cm) Planted Seed Set
 Discolouration Unknown None

Assess below live crown
 #Epic-Live #Epic-Dead #Open #Sooty
 Root Bark Type =<2m # Callused Wounds >2m

Metres from badly cankered tree
 < 40 > 40 None Found

Competing Species

Tree # Zone Easting Northing
 1

Crown Class Live Crown % Main Stem Length(m) Below crown Seed Signs
 Twig Dieback #Stems Butternut Origin Male Flowers
 Branch Dieback Natural Female Flowers
 Defoliation DBH(cm) Planted Seed Set
 Discolouration Unknown None

Assess below live crown
 #Epic-Live #Epic-Dead #Open #Sooty
 Root Bark Type =<2m # Callused Wounds >2m

Metres from badly cankered tree
 < 40 > 40 None Found

Competing Species

Tree # Zone Easting Northing
 1

Crown Class Live Crown % Main Stem Length(m) Below crown Seed Signs
 Twig Dieback #Stems Butternut Origin Male Flowers
 Branch Dieback Natural Female Flowers
 Defoliation DBH(cm) Planted Seed Set
 Discolouration Unknown None

Assess below live crown
 #Epic-Live #Epic-Dead #Open #Sooty
 Root Bark Type =<2m # Callused Wounds >2m

Metres from badly cankered tree
 < 40 > 40 None Found

Competing Species

Tree # Zone Easting Northing
 1

Crown Class Live Crown % Main Stem Length(m) Below crown Seed Signs
 Twig Dieback #Stems Butternut Origin Male Flowers
 Branch Dieback Natural Female Flowers
 Defoliation DBH(cm) Planted Seed Set
 Discolouration Unknown None

Assess below live crown
 #Epic-Live #Epic-Dead #Open #Sooty
 Root Bark Type =<2m # Callused Wounds >2m

Metres from badly cankered tree
 < 40 > 40 None Found

Competing Species

Please enter matching page link code on forms 1 and 2

Page Link 006

(Contact Information follows all applicable privacy policies and guidelines)

Please return forms to:
 Forest Gene Conservation Association
 Suite 233, 266 Charlotte St.
 Peterborough, ON, K9J 2V4
 www.fgca.net

49731



BHA Tree Analysis (version: December 2013)

This table is to be completed by a designated Butternut Health Assessor (BHA).

BHA Report #	6	Assessment Date(s)	June 22, 2019	Total # Butternut Trees in BHA Report	1
--------------	---	--------------------	---------------	---------------------------------------	---

BHA ID #	289	BHA Name	Heather Lunn
----------	-----	----------	--------------

Landowner / Client Name	Maurice Decaria
-------------------------	-----------------

Property Location	Lot 03 Concession 02 Drummond Geographic Township, Town of Perth
-------------------	--

Tree #	Live Crown %	Tree dbh (cm)	input field data				automatic calculations from field data				Circ. (cm)	BC (cm)	RC (cm)	BC%	RC%	BRC%	Categories: 1: non-retainable, 2: retainable, 3: archivable	FINAL TREE CALL a Cat 2, dbh>20cm <40m from a Cat 1
			sooty (S) (will be assigned 2.5 cm per canker)	open (O) (will be assigned 5 cm per canker)	# root flare (RF) cankers	<40 m from cankered tree? (Y or N)	total bole canker width (sooty x 2.5 + open x 5)	total RF canker width (sooty x 2.5 + open x 5)	bole canker % of circ.	RF canker % of circ.								
1	75	62	0	0	0	0	0	0	2	194.68	0.0	10.0	0.0	5.1	2.6	2	2	2
2																		
3																		
4																		
5																		
6																		
7																		
8																		
9																		
10																		
11																		
12																		
13																		
14																		
15																		
16																		
17																		