

Engineering

Land/Site
Development

Municipal
Infrastructure

Environmental/
Water Resources

Traffic/
Transportation

Recreational

Planning

Land/Site
Development

Planning Application
Management

Municipal Planning

Urban Design

Expert Witness
(LPAT)

Wireless Industry

Landscape Architecture

Streetscapes &
Public Amenities

Open Space, Parks &
Recreation

Community &
Residential

Commercial &
Institutional

Environmental
Restoration



Mill Run Extension-Phases 7 and 8 Transportation Impact Statement

February 9, 2023

Julie Stewart, County Planner
County of Lanark
Planning Department
99 Christie Lake Road
Perth, ON K7H 3C6

Melanie Knight, Senior Planner
Municipality of Mississippi Mills
Planning Department
3131 Old Perth Rd, Box 400
Almonte ON, K0A 1A0

**Reference: Transportation Impact Statement
Mill Run Extension - Phases 7 and 8
Town of Mississippi Mills, County of Lanark
Our File No.: 121125**

This Traffic Impact Study has been prepared in support of the Draft Plan of Subdivision application for the Mill Run Extension, Phases 7 and 8, located north of Leishman Drive west of Ramsay Concession 11A and Martin Street.

This study provides a description of the development proposal, a summary of the existing conditions, and an updated estimate of the projected site traffic during the weekday AM and PM peaks. The internal road pattern and access configuration are also assessed.

If you have any questions or comments regarding this report, please feel free to contact Brad Byvelds, or the undersigned.

Yours truly,

NOVATECH

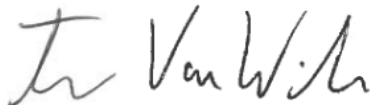

Trevor Van Wiechen, M.Eng.
E.I.T. | Transportation

1.0 PROPOSED DEVELOPMENT

The subject site has an area of approximately 5.6 hectares. The proposed development consists of 47 single detached housing units, 18 semi-detached housing units, and 60 townhouses. The development includes an extension of Sadler Drive to the north, two streets to the east of Sadler Drive, and a street to the west of Sadler Drive that ends in a cul-de-sac. A copy of the proposed Draft Plan and Concept Plan is shown in **Appendix A**.

2.0 EXISTING CONDITIONS

2.1 Roadways and Intersections

Sadler Drive is a local two-lane urban road with sidewalks on either side and runs in the north-south direction. The speed limit is not posted and therefore has a regulatory speed limit of 50km/h under the Ontario Highway Traffic Act.

The Ottawa Street at Sadler Drive/Industrial Drive intersection is a four legged signalized intersection. The westbound and eastbound legs of Ottawa Street have a turn lane, a through lane, and a shared through/right turn lane. The southbound leg of Sadler Drive has a left turn lane and a shared through/right turn lane. The northbound leg of Industrial Drive has a shared through/left turn lane and a channelized right turn lane. All legs of the intersection have standard crosswalks.

Figure 1: Key Plan

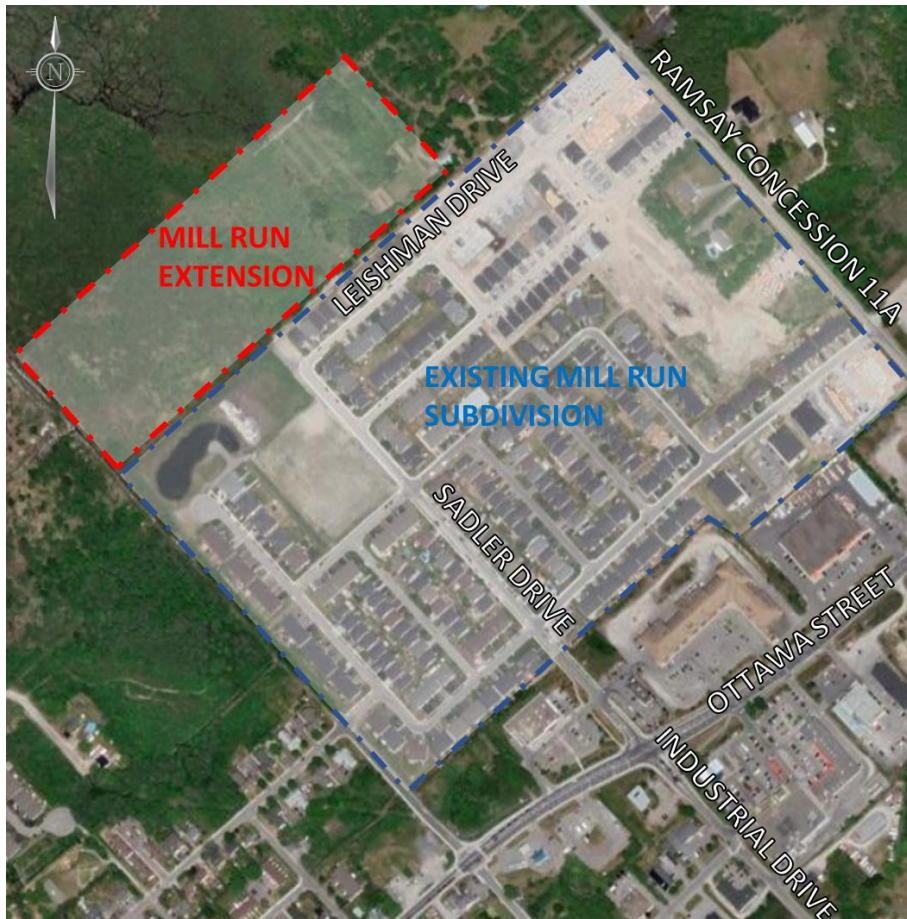

2.2 Traffic Volumes

In February 2020, Parsons prepared a Traffic Safety Review memorandum for the Municipality of Mississippi Mills. As part of this memorandum, weekday ten hour turning movement counts were conducted in November 2019 at the nearby intersections of Sadler Drive/Industrial Drive/Ottawa Street, Menzie Street/Paterson Street/Ottawa Street and Main Street/Martin Street/Ottawa Street. Volumes from the 2019 traffic count were then factored by an annual 2% growth rate to adjust for 2023 traffic volumes. A copy of the Parsons November 2019 traffic count data is included in **Appendix B** and the factored 2023 traffic volumes for the Sadler Drive/Industrial Drive/Ottawa Street are shown in **Figure 2**.

Figure 2: Factored Traffic Volumes

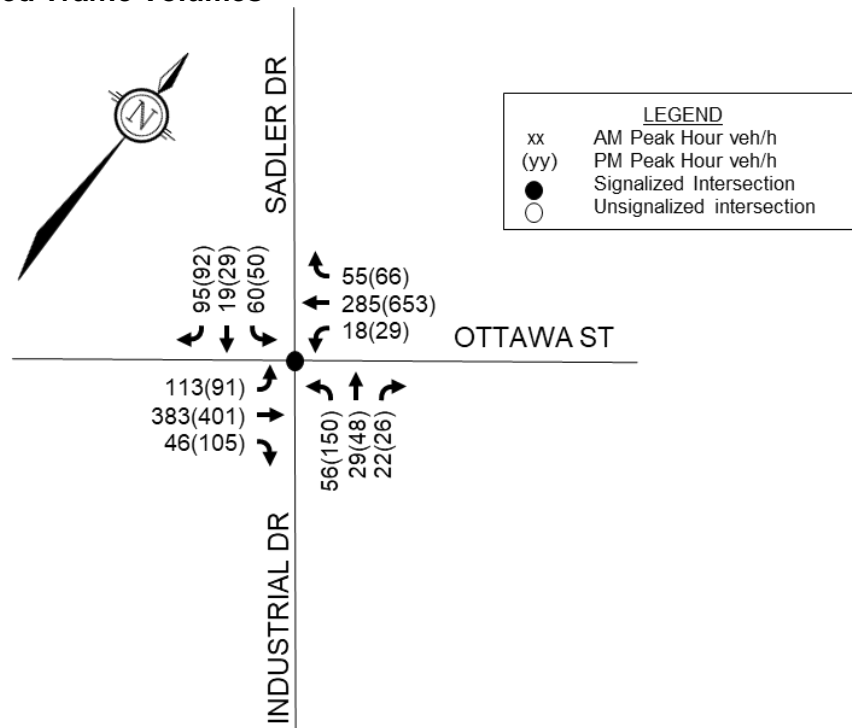

3.0 TRIP GENERATION AND DISTRIBUTION

Trips generated by the proposed development have been estimated using relevant peak hour trip generation rates identified in the Institute of Transportation Engineers (ITE) Trip Generation Manual, 11th Edition. The estimated peak hour vehicle trips generated by the proposed development during the weekday AM and PM peak hours are outlined in the following table.

Table 1: Trip Generation

Land Use	ITE Code	Dwelling Units	AM Peak (vph ¹)			PM Peak (vph)		
			IN	OUT	TOTAL	IN	OUT	TOTAL
Single-Family Detached	210	47	9	28	37	31	18	49
Semi-Detached	215	18	1	3	4	4	3	7
Townhouse	220	60	10	31	41	29	17	46
TOTAL			20	62	82	64	38	102

1. vph = vehicles per hour

The assumed distribution of trips generated by the proposed development has been estimated based on the local and commuter traffic patterns. The trip distribution assumptions for trips generated by the proposed development are as follows:

- 50% to/from the east
- 10% to/from the south
- 40% to/from the west

Using the trips generated and the assumed trip distribution the following **Figure 3** was created to show the generated turning movements at the Sadler Drive/Ottawa Street/Industrial Drive intersection. Total traffic volumes at this intersection are shown in **Figure 4**.

Figure 3: Site Generated Traffic

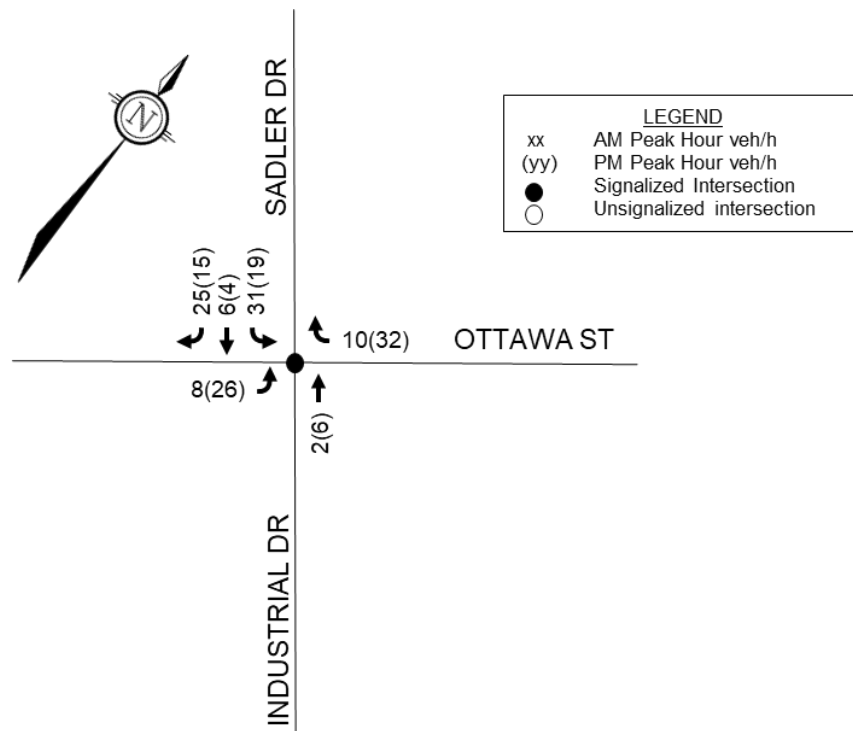
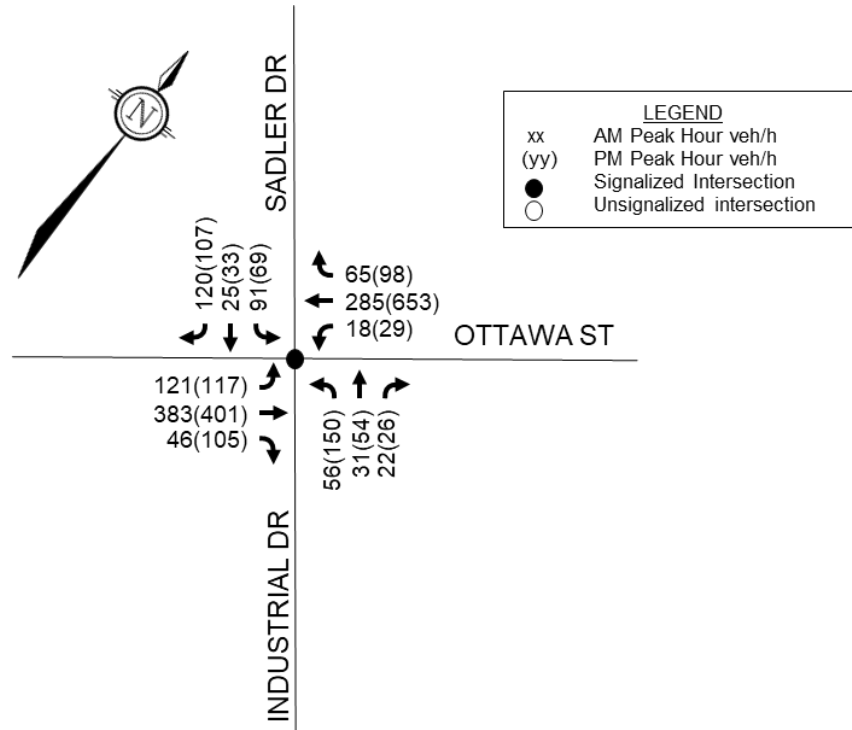

Figure 4: Total Traffic



4.0 IMPACT ANALYSIS

Based on the intersection analysis presented in the Parsons Traffic Safety Review Memorandum, the Ottawa Street/Industrial Street/Sadler Street intersection operates with a LOS A during the AM peak hour and a LOS B during the PM peak hour. Relevant excerpts from the Parsons Memorandum are provided in **Appendix C**.

During the weekday AM and PM peak hours, the additional trips generated by the proposed development equate to an overall increase of 6-7% to the existing traffic volumes at the Sadler Drive/Ottawa Street/Industrial Drive intersection. The additional traffic is considered relatively insignificant compared to the typical capacity of the signalized intersection.

The increase in traffic volumes is not anticipated to have a significant impact to the intersection operations presented in the Parsons Memorandum.

5.0 ON-SITE DESIGN

The proposed access to the development is a northern extension of Sadler Drive and creates a 3-way intersection where Sadler Drive meets Leishman Drive. The proposed extension of Sadler Drive is roughly 200m long and has a 20m right-of-way (ROW) which is consistent with the existing portion of Sadler Drive south of the proposed development.

The proposed internal road network includes Streets 1, 2, and 3. Streets 1 and 2 run east-west between Sadler Drive and the eastern edge of Phase 7. Street 3 begins at the intersection of Sadler Drive and Street 2 and heads westbound and ends in a cul-de-sac. All three internal streets have a 18m wide ROW.

The TAC Geometric Design Guide specifies that for local roads three-legged intersections must be spaced 40m apart while four-legged intersections need to be spaced 60m apart. As the internal roadways are spaced roughly 80m apart from each other and Street 1 is roughly 80m from Leishman Drive this satisfies the required distance for all intersections.

Sidewalks have been proposed along both sides of Sadler Drive, the south side of Street 1, and the north side of Street 2 and 3. Sidewalks were placed to provide connectivity to the residential development to the south as well as the Mill Run Park. A new pathway will be provided within Servicing Block 63 shown on the Draft Plan to connect to the pathway as part of Phase 4 of the Mill Run subdivision. The pathway along the north and west edge of the existing stormwater management pond will be removed and replaced with a new pathway connecting the terminus of Street 3 to Sadler Drive.





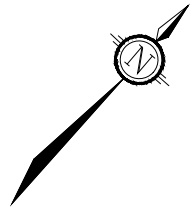

Side street stop control on the minor street is proposed at each of the proposed intersections.

The proposed network and pathways plan is included in **Figure 5**.

M:\2021\121125\CAD\Design\Figures\Traffic\121125-NPP.dwg, NPP, Feb 08, 2023 - 3:29pm, smatthews



LEGEND

-  PROPOSED CONCRETE SIDEWALK
-  PROPOSED FUTURE CONCRETE SIDEWALK
-  EXISTING PARK PATHWAYS
-  EXISTING PARK PATHWAYS TO BE REMOVED
-  PROPOSED PATHWAYS
-  VEHICLE CONNECTIONS TO FUTURE DEVELOPMENT LANDS
-  PROPOSED STOP SIGNS

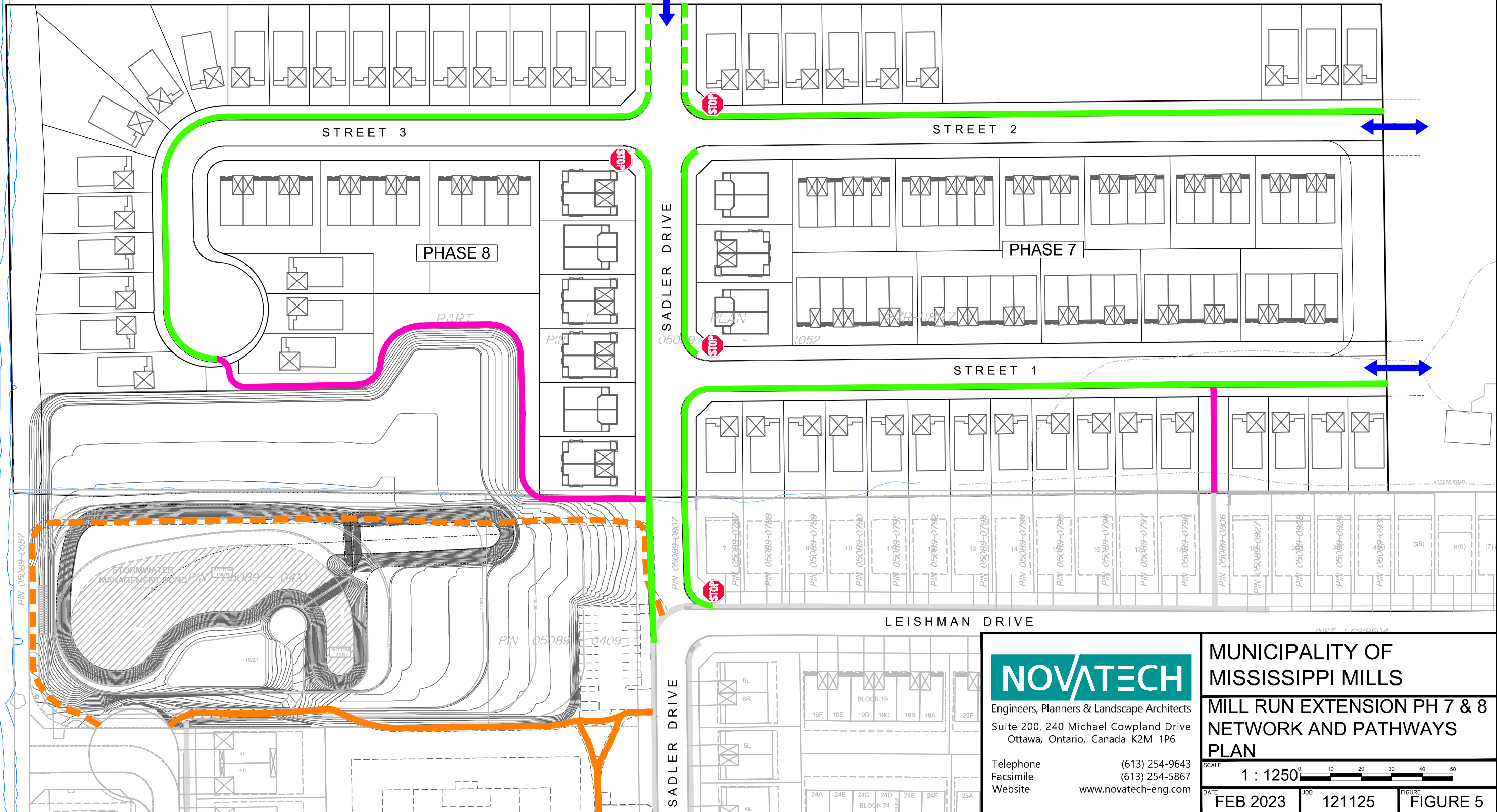

NOVATECH
 Engineers, Planners & Landscape Architects
 Suite 200, 240 Michael Cowpland Drive
 Ottawa, Ontario, Canada K2M 1P6
 Telephone (613) 254-9643
 Facsimile (613) 254-5867
 Website www.novatech-eng.com

MUNICIPALITY OF MISSISSIPPI MILLS
MILL RUN EXTENSION PH 7 & 8 NETWORK AND PATHWAYS PLAN
 SCALE 1 : 1250
 DATE FEB 2023 JOB 121125 FIGURE FIGURE 5

6.0 CONCLUSIONS AND RECOMMENDATIONS

Based on the foregoing, the conclusions and recommendations of this Transportation Impact Statement can be summarized as follows:

- The marginal increase in traffic volumes attributable to the additional trips generated by the proposed development is not anticipated to have a significant impact to the intersection operations at the Ottawa Street/Industrial Street/Sadler Drive intersection.
- All internal roadways meet TAC requirements as intersections have appropriate spacing.
- The internal sidewalk network will provide connectivity to the residential development to the south as well as the Mill Run Park. The pathway along the northern edge of the existing stormwater management pond will be removed and replaced with a new pathway connecting the terminus of Street 3 to Sadler Drive.

The proposed development is recommended from a transportation perspective.

Yours truly,

NOVATECH

Prepared by:

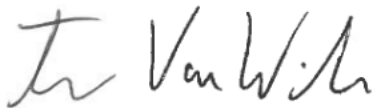

Trevor Van Wiechen, M.Eng.
E.I.T. | Transportation

Reviewed by:



Brad Byvelds, P.Eng.
Project Manager | Transportation

APPENDIX A

Draft Plan & Concept Plan

SCHEDULE OF LANDUSE

BLOCK #'s	LAND USE	UNITS	AREA (hectares)
1-16, 25-56	RESIDENTIAL (Single Family Homes)	47	2.24
17-25	RESIDENTIAL (Semi Detached Homes)	18	0.53
57-60	RESIDENTIAL (Townhomes)	60	1.49
61-62	OPEN SPACE		0.49
63	STORMWATER MANAGEMENT		0.75
64-65	SERVICING		0.11
TOTAL			5.61

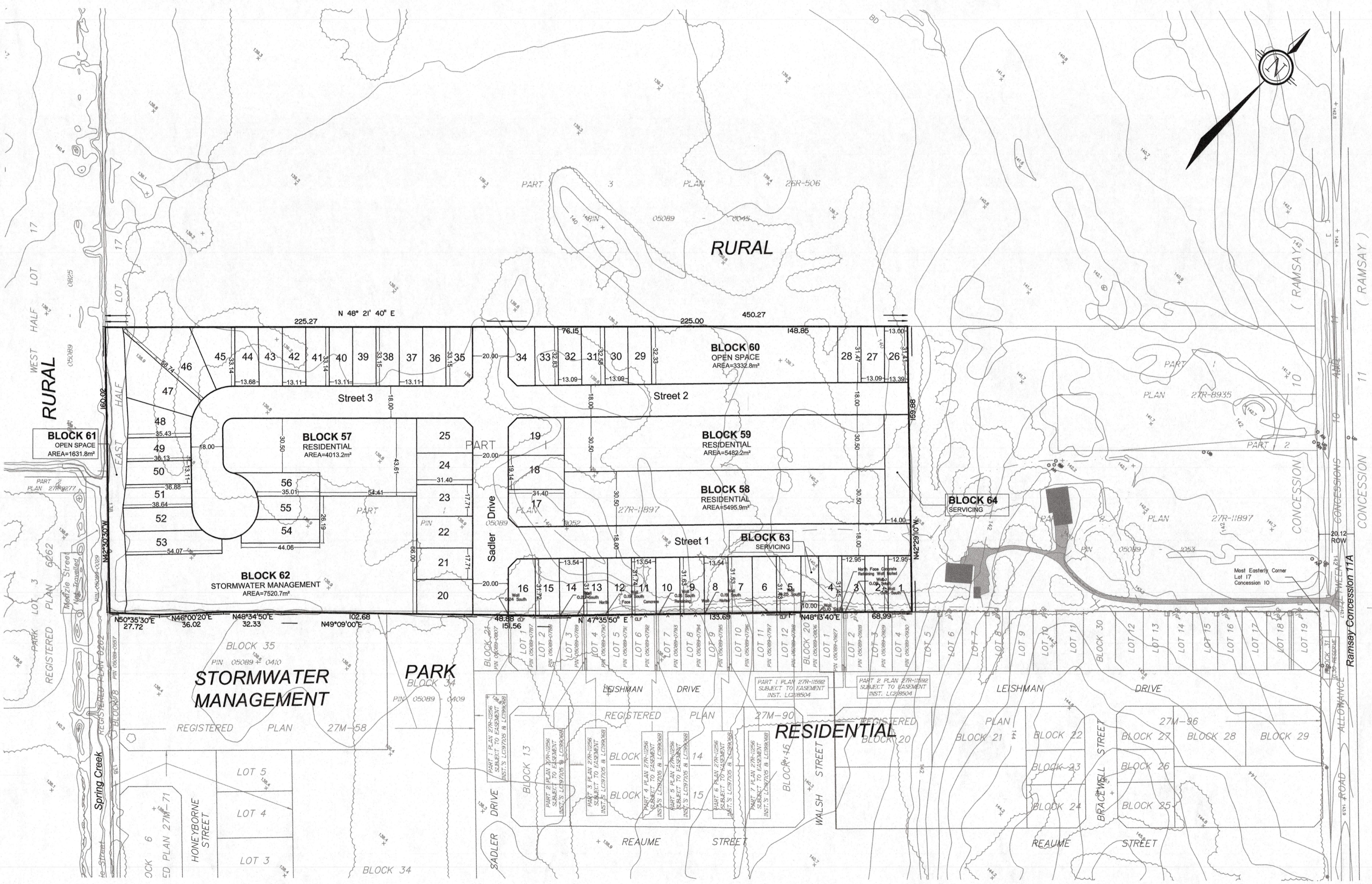
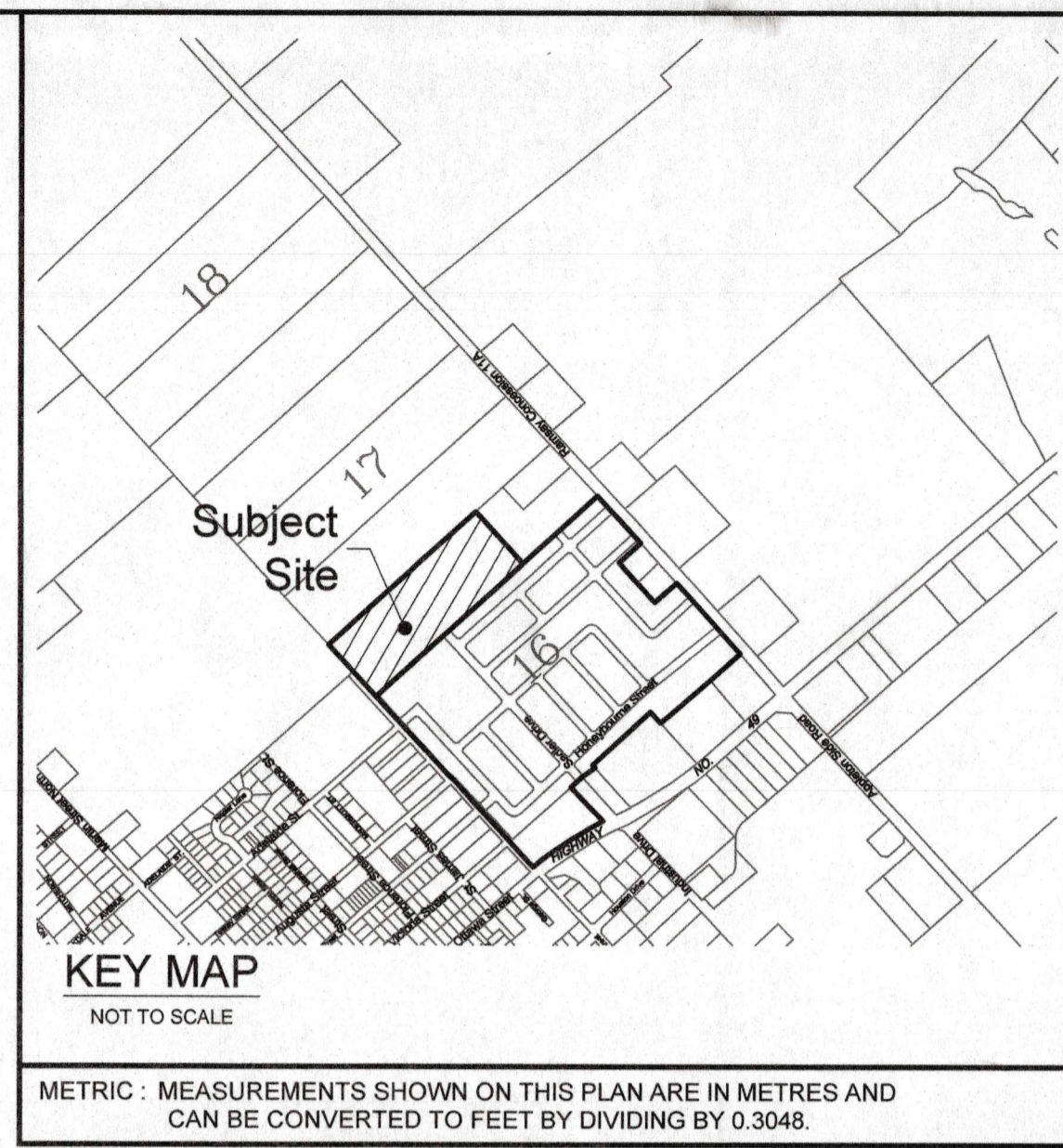

DRAFT PLAN OF SUBDIVISION OF
PART OF LOT 17
CONCESSION 10
 Geographic Township of Ramsay
MUNICIPALITY OF MISSISSIPPI MILLS
COUNTY OF LANARK

SCALE
 1 : 1250

DATE: JANUARY, 2023

SURVEYOR'S CERTIFICATE

I HEREBY CERTIFY THAT THE BOUNDARIES OF THE LANDS TO BE SUBDIVIDED AND THEIR RELATIONSHIP TO ADJOINING LANDS ARE CORRECTLY SHOWN.

DATED Feb 6/23

T. Harwick
 ONTARIO LAND SURVEYOR

ANNIS O'SULLIVAN, VOLLEBECK LTD.
 ONTARIO LAND SURVEYORS
 Project No. 23126-22

OWNER'S CERTIFICATE

THIS IS TO CERTIFY THAT WE, MENZIE ALMONTE 2 INC., ARE THE OWNERS / AGENTS OF THE LANDS TO BE SUBDIVIDED AND THAT THIS PLAN WAS PREPARED IN ACCORDANCE WITH OUR INSTRUCTIONS.

Fd 6/23
 DATE

David Kardish (Assistant Secretary)
 I have the authority to bind the corporation

- ADDITIONAL INFORMATION REQUIRED UNDER SECTION 51 (17) OF THE PLANNING ACT.**
- A) The boundaries of the land proposed to be subdivided, certified by an Ontario Land Surveyor.
 - B) The locations, widths & names of the proposed highways within the proposed subdivision & of existing highways on which the proposed subdivision abuts.
 - C) On a small keyplan, on a scale of not less than 1cm to 100m, all of the land adjacent to the proposed subdivision that is owned by the applicant in which the applicant has an interest, every subdivision adjacent to the proposed subdivision & the relationship of the boundaries of the land to be subdivided to the boundaries of the township lot of other original grant of which the land forms the whole part.
 - D) The purposes for which the proposed lots are to be used.
 - E) The existing uses of all adjoining lands.
 - F) The approximate dimensions & layout of the proposed lots.
 - G) Natural & artificial features such as buildings or other structures or installations, railways, highways, watercourses, drainage ditches, wetlands & wooded areas within or adjacent to the land proposed to be subdivided.
 - H) The availability and nature of domestic water supplies.
 - I) The nature & porosity of the soil.
 - J) Existing contours or elevations as may be required to determine the grade of the highways and the drainage of the land proposed to be subdivided.
 - K) The municipal services available or to be available to the land proposed to be subdivided.
 - L) The nature & extent of any restrictions affecting the land proposed to be subdivided, including restrictive covenants or easements, 1994, c. 23, s. 30, 1996, c. 4, s. 28 (3).

MILL RUN EXTENSION

NOVATECH
 Engineers, Planners & Landscape Architects
 Suite 200, 240 Michael Cowpland Drive
 Ottawa, Ontario, Canada K2M 1P6

Telephone (613) 254-9643
 Facsimile (613) 254-5867
 Website www.novatech-eng.com

PROJECT No. 121125

Y:\REGIONAL GROUP\23126-22 Regional Almonte Mill Land\Draft Plan of Subdivision\MacNovatech_Draft Plan of Subdivision_2023.02.06.12125.DP3.dwg, DP-A1, Feb. 06, 2023, 8:30am, F:\Users\

Phases	Single Lots							Semi-Detached Lots			Townhouse Lots			Total Units	
	43' Lots		50' Lots		Subtotal		Target Mix	Semi-Detached		Target Mix	Townhouses		Target Mix	Units	%
	Units	%	Units	%	Units	%	%	Units	%	%	Units	%	%	Units	%
PHASE 7															
Sub-Total	25	32%	0	0%	25	32%	20%	6	8%	20%	48	61%	60%	79	100%
PHASE 8															
Sub-Total	22	48%	0	0%	22	48%	20%	12	26%	20%	12	26%	60%	46	100%
Total	47	38%	0	0%	47	38%	20%	18	14%	20%	60	48%	60%	125	100%

Dwelling Type	Phase 7			Phase 8			Overall Site		
	# Units	Area (ha)	Net Density (units/ha)	# Units	Area (ha)	Net Density (units/ha)	# Units	Area (ha)	Net Density (units/ha)
PHASE 7 & 8									
Detached	25	1.07	23	22	1.17	19	47	2.24	21
Semi-Detached	6	0.19	32	12	0.34	35	18	0.53	34
Townhouse	48	1.10	44	12	0.40	30	60	1.49	40
Total	79	2.35	34	46	1.91	24	125	4.26	29

Phases	# Units	% Mix	Overall Site		
			OP Target Mix	Net Density (units/ha)	OP Target (units/net ha)
PHASE 7 & 8	65	52%	60%	23	15 - 30
Low Density	60	48%	40%	40	30 - 40
Medium Density	-	-	-	-	-
High Density	-	-	-	-	-

Low Density = Single Lots + Semi-Detached Lots
 Medium Density = Townhouse Lots

- LEGEND:**
- 43' WIDE MODELS
 - SEMI DETACHED
 - FREEHOLD 2-STORY TOWNHOUSES
 - FREEHOLD BUNGALOW TOWNHOUSES
 - STORMWATER MANAGEMENT POND / PARK
 - WALKWAY / SERVICING BLOCK
 - PARK LANDS
 - NATURALIZED BUFFER

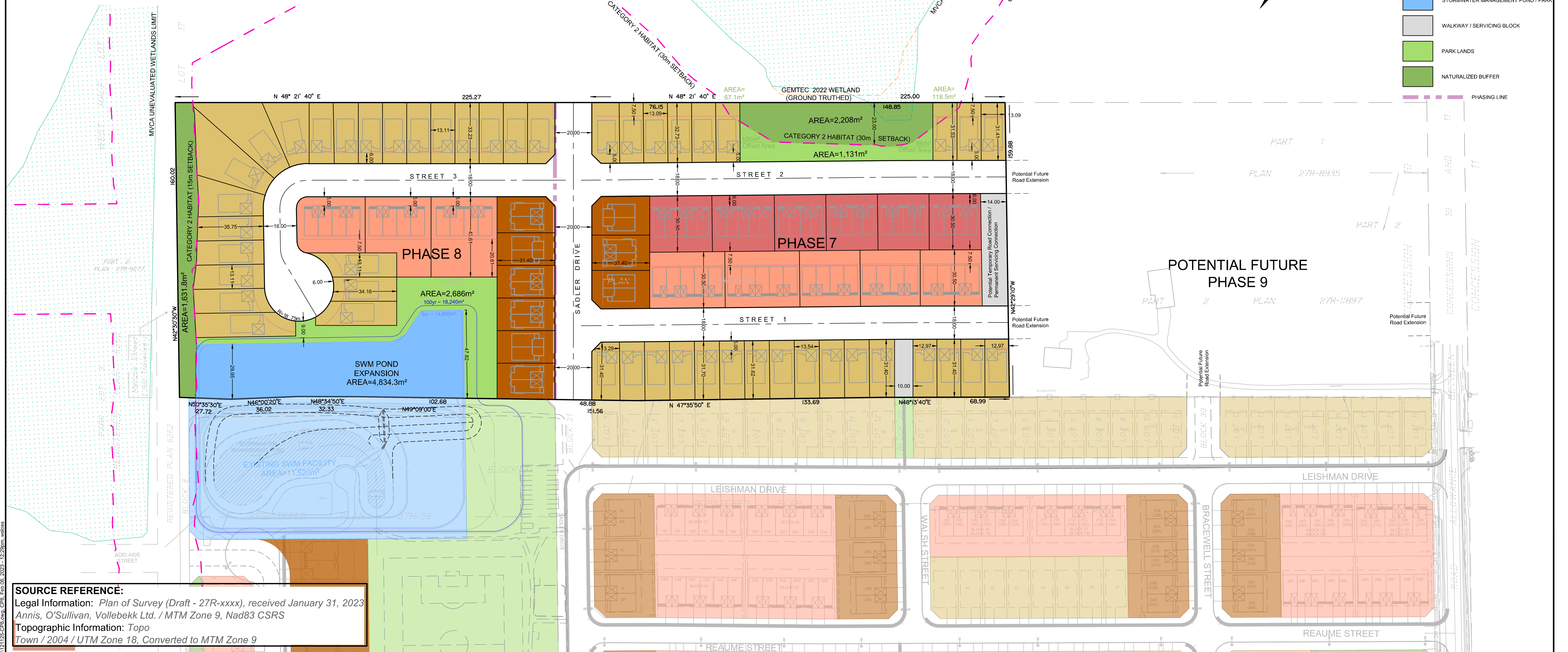
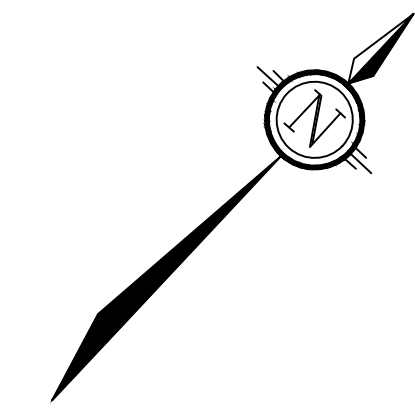

SOURCE REFERENCE:
 Legal Information: Plan of Survey (Draft - 27R-xxxx), received January 31, 2023
 Annis, O'Sullivan, Vollebek Ltd. / MTM Zone 9, Nad83 CSRS
 Topographic Information: Topo
 Town / 2004 / UTM Zone 18, Converted to MTM Zone 9

Net Density means the total number of dwelling units divided by the area of land (project area) in exclusively residential use, including lands and parking area internal to development and private amenity area, but excluding public streets, parks and open space, infrastructure and all non-residential uses.

REVISION				SCALE		DESIGN	
3	REVISED PHASE 8 TOWNS / UPDATED LEGAL LINEWORK	FEB 2/23	DDB	1:1000 (A1) / 1:2000 (11x17)		CHECKED	DDB
2	ISSUED FOR DRAFT PLAN APPLICATION	JAN 11/23	DDB			DRAWN	MER
1	ISSUED FOR CLIENT REVIEW	NOV 30/22	DDB			CHECKED	SM
No.	REVISION	DATE	BY			APPROVED	MER
							DDB

NOVATECH
 Engineers, Planners & Landscape Architects
 Suite 200, 240 Michael Cowpland Drive
 Ottawa, Ontario, Canada K2M 1P6
 Telephone: (613) 254-9643
 Facsimile: (613) 254-5867
 Website: www.novatech-eng.com

MISSISSIPPI MILLS
 MILL RUN EXTENSION - PHASES 7 and 8
 DRAWING NAME
CONCEPT PLAN 8
 PROJECT No. 121125-00
 REV #3
 DRAWING No. 121125-CP8

M:\2021\121125\CP8\Planning\Concept Plans\121125-CP8.dwg, CPL File 06, 2023, 12:29pm, wdelmas

APPENDIX B

Traffic Count Data



Turning Movement Count Summary, AM and PM Peak Hour Flow Diagrams

Automobiles, Taxis, Light Trucks, Vans, SUV's, Motorcycles, Heavy Trucks, Buses, and School Buses

Industrial Drive/Sadler Drive & Ottawa Street Almonte, ON

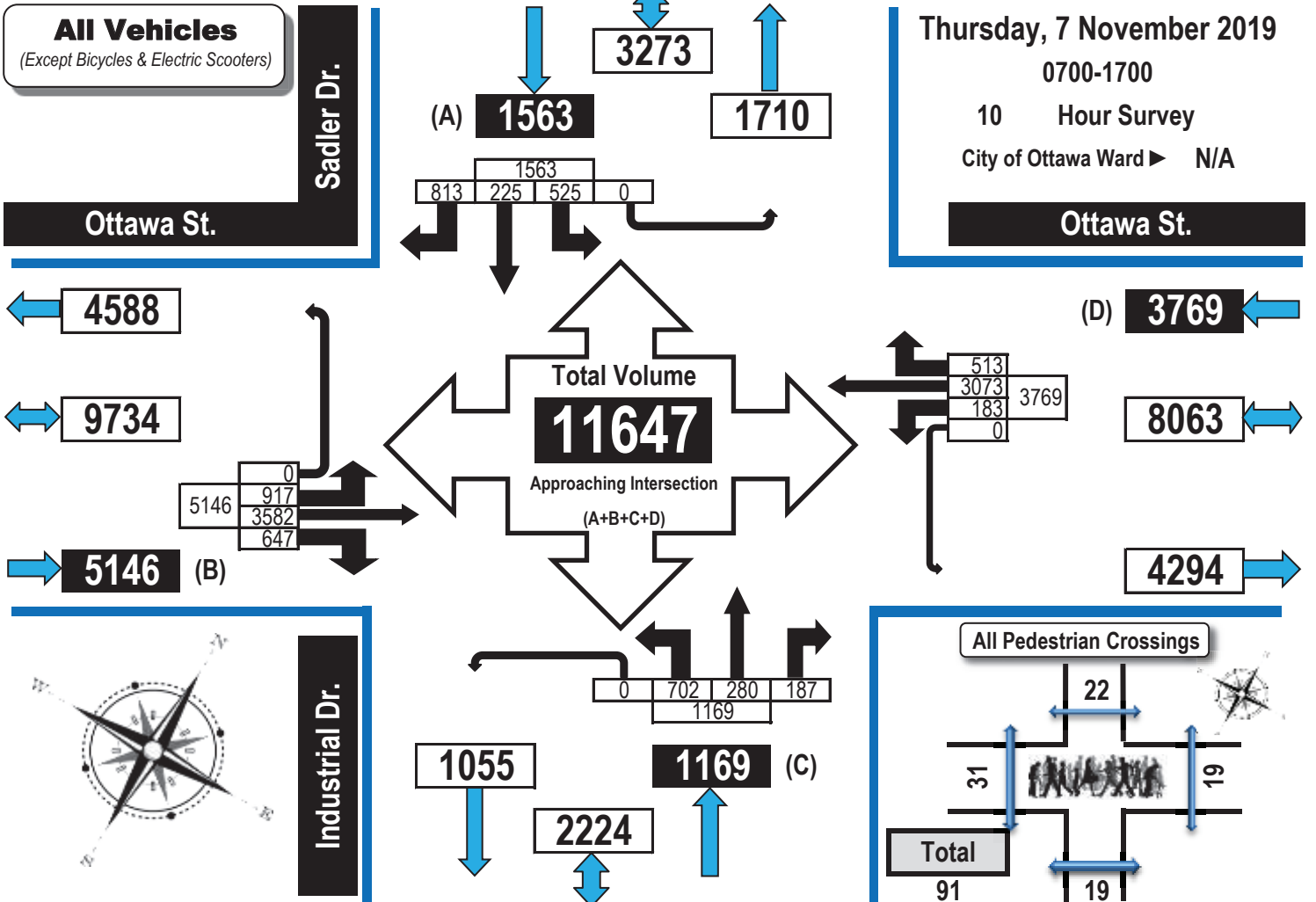

AM Peak Hour Flow Diagram PM Peak Hour Flow Diagram

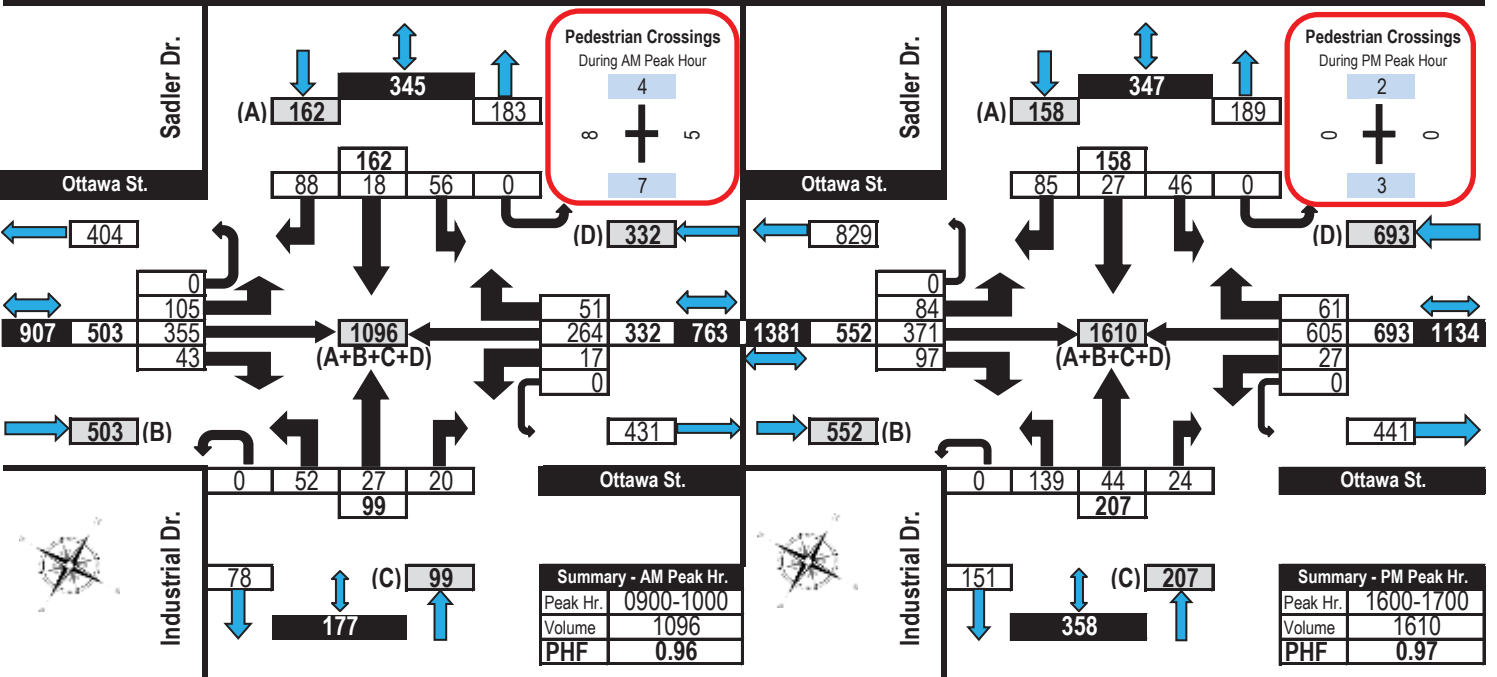

APPENDIX C

Excerpts From the Parsons Traffic Safety Review Memorandum

3.3. INTERSECTION OPERATION PERFORMANCE

In the following section, the operational capacity of study area intersections will be assessed using Synchro v10 analysis software. The purpose of this analysis is to identify whether there is vehicular congestion that may contribute to safety concerns. The peak hour traffic volumes from **Figure 5** were entered and modelled in Synchro. The criteria for the analysis have been summarized below.

3.3.1. INTERSECTION ANALYSIS CRITERIA

For signalized intersections, the Level of Service (LOS) defines operational conditions within a traffic stream and their perception by motorists. LOS 'A' represents the best operating conditions and LOS 'E' represents the level which the intersection or an approach to the intersection is carrying the maximum traffic volume that can theoretically be accommodated. LOS 'F' indicates that the intersection is operating beyond its theoretical capacity.

For the purposes of this analysis, the City of Ottawa criteria for LOS has been referenced. These criteria were developed as part of the Transportation Impact Assessment Guidelines, which relate a LOS designation to be defined range. These criteria are as follows:

Table 2: LOS Criteria for Signalized Intersections

LOS	Volume to Capacity Ratio (v/c)
A	0 to 0.60
B	0.61 to 0.70
C	0.71 to 0.80
D	0.81 to 0.90
E	0.91 to 1.00
F	>1.00

A LOS 'D' or better is considered acceptable operations based on City of Ottawa Standards. Based on these criteria, the operational capacity at the study area intersections were assessed in the following section.

3.3.2. INTERSECTION ANALYSIS RESULTS

Table 3 provides a summary of the existing traffic operations at the study area intersections. The signalized intersections were assessed in terms of the volume-to-capacity (v/c) ratio and the corresponding Level of Service (LOS) for the critical movement(s) and for the entire intersection, the latter was assessed based on weighted v/c ratio. The Synchro model output of existing conditions is provided within **Appendix E**.

Table 3: Existing Intersection Performance

Intersection	Weekday AM(PM) Peak Hour Operational Results					
	Critical Movement			Intersection		
	max. v/c	LOS	Movement	Delay (s)	LOS	v/c
Martin/Ottawa	0.49(0.58)	A(A)	EBT(WBL)	12.4(12.5)	A(A)	0.39(0.55)
Paterson/Ottawa	0.62(0.64)	B(B)	NBT(WBT)	13.1(14.7)	A(A)	0.50(0.60)
Industrial/Ottawa	0.26(0.63)	A(B)	WBT(WBT)	10.4(16.8)	A(A)	0.23(0.56)

Note: Analysis of signalized intersections assumes a PHF of 0.95 and a saturation flow rate of 1800 veh/h/lane.

As shown in **Table 3**, the study area intersections currently operate at an excellent LOS 'A' during the morning and afternoon peak hours. With regard to 'critical movements' at study area intersections, they are operating at an acceptable LOS 'B' or better during peak hours. Therefore, vehicle related congestion is not expected to be a contributing factor to the noted safety concerns.